

14

Страницы раздела
001-042

ЗАЖИМЫ АРТЕРИАЛЬНЫЕ ARTERY FORCEPS

Перейти в **СОДЕРЖАНИЕ**

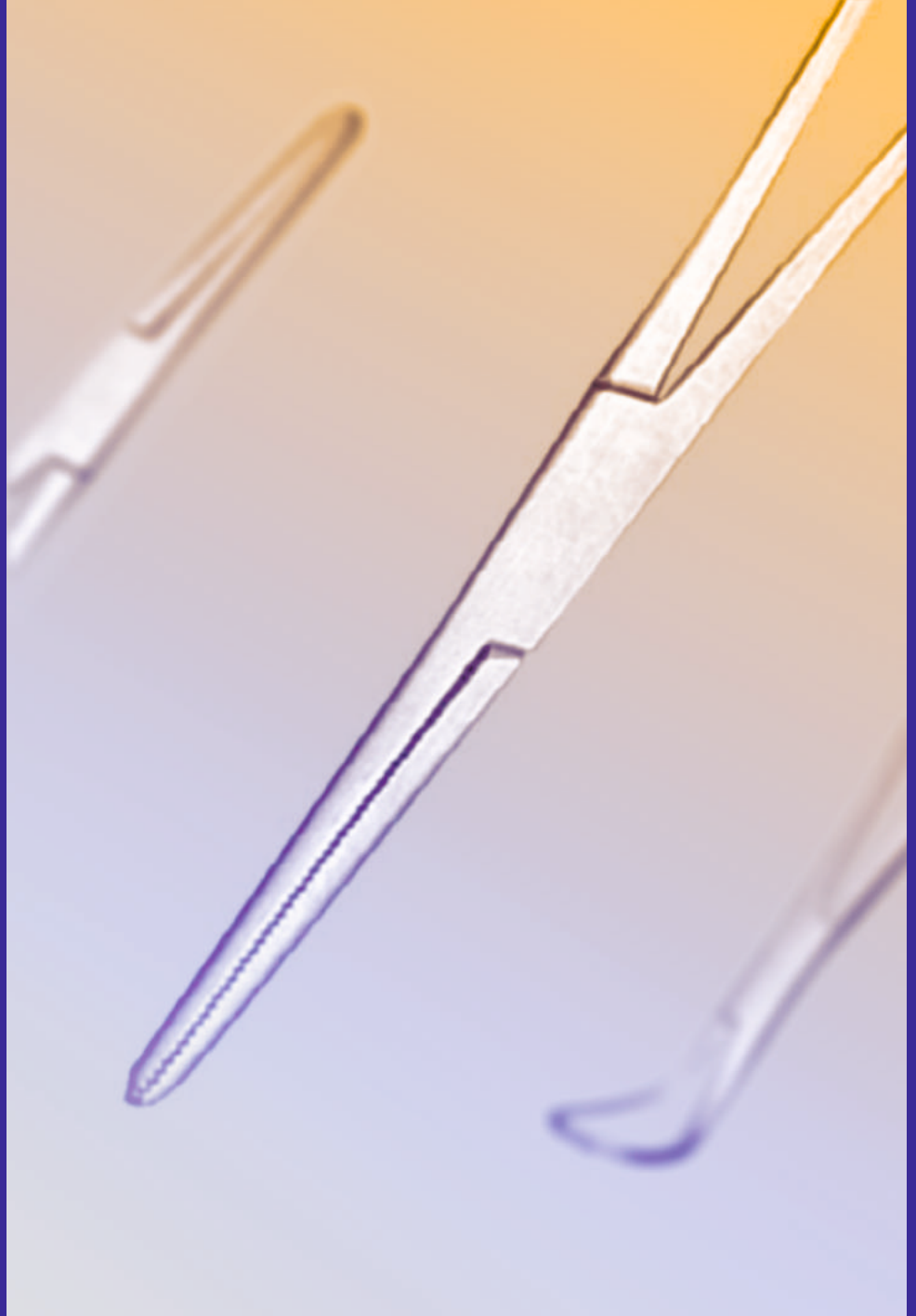

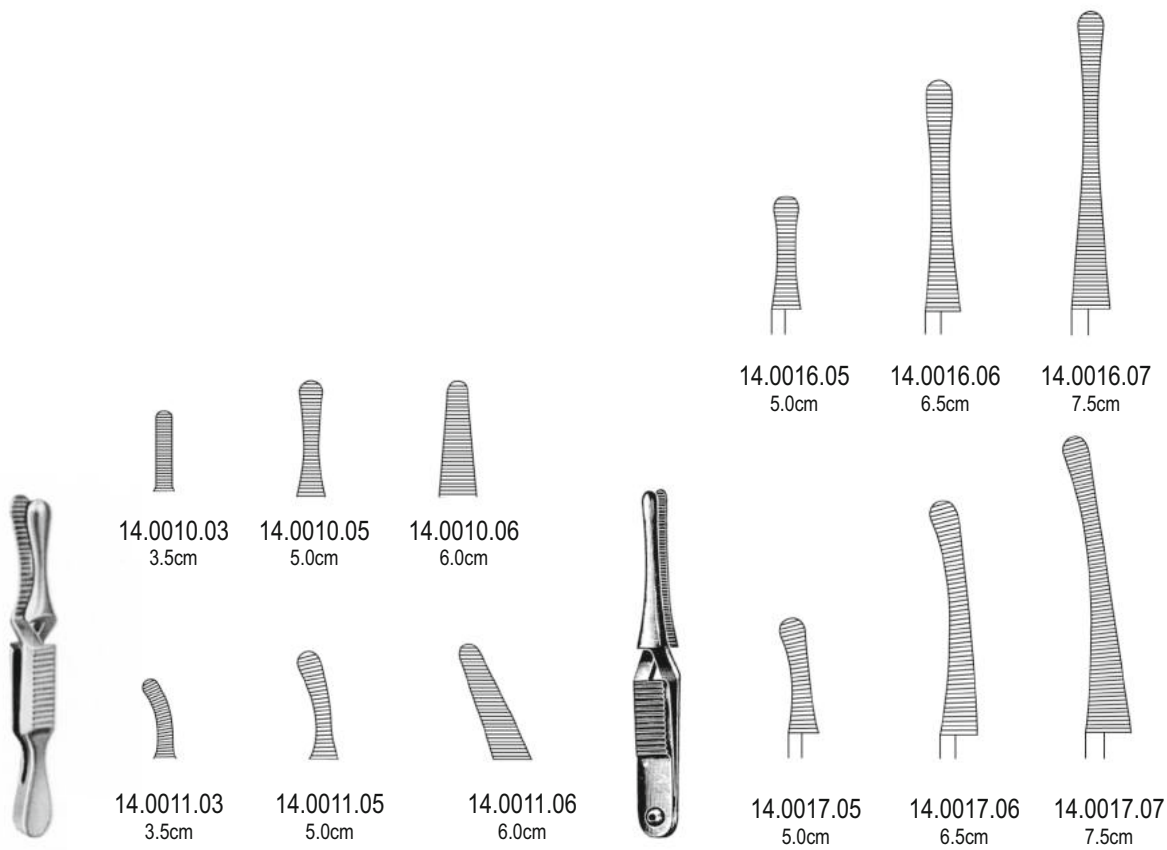

DIEFFENBACH

JOHNS-HOPKINS

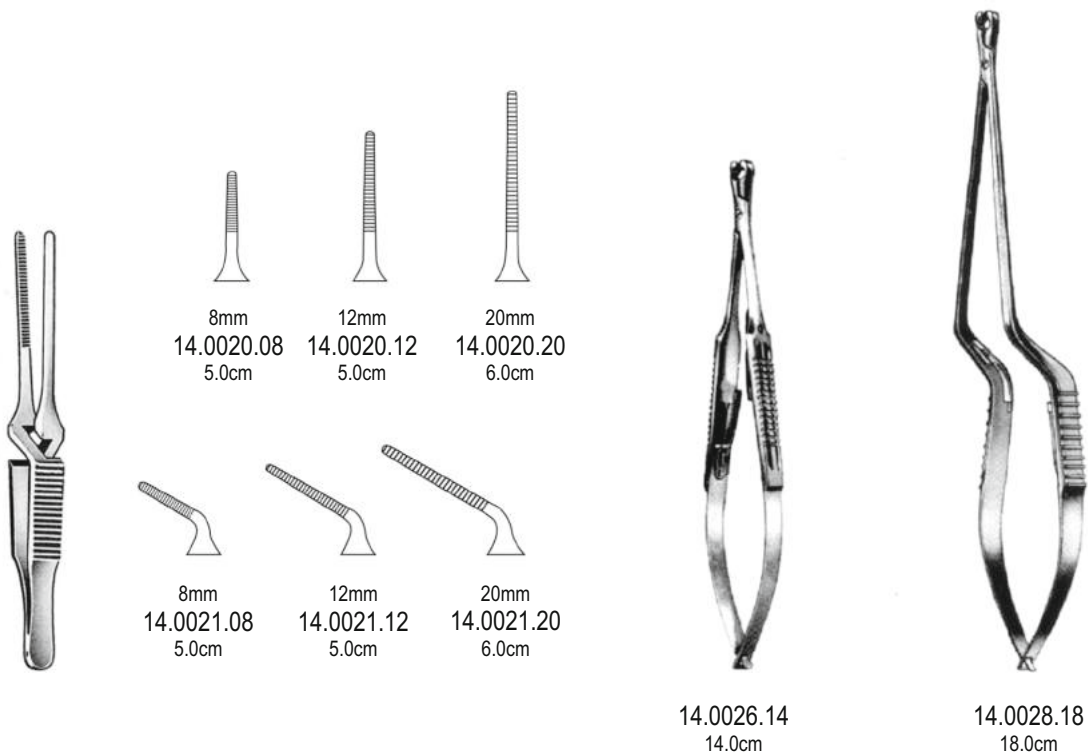



HARTMANN
14.0030.10 10.0cm 14.0031.10

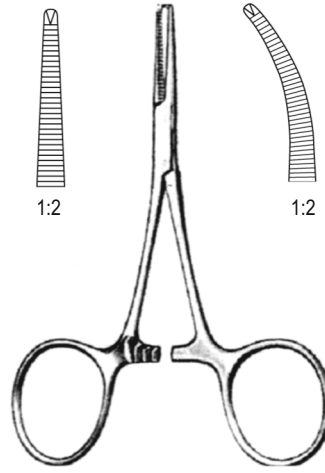

HARTMANN
14.0032.10 10.0cm 14.0033.10



CARREL
14.0040.08 8.5cm

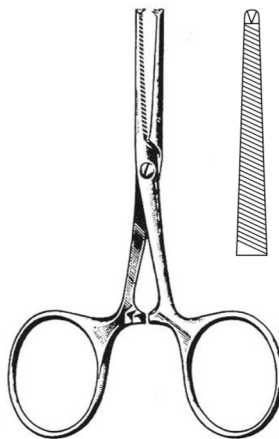

TERRIER
14.0044.08 8.5cm

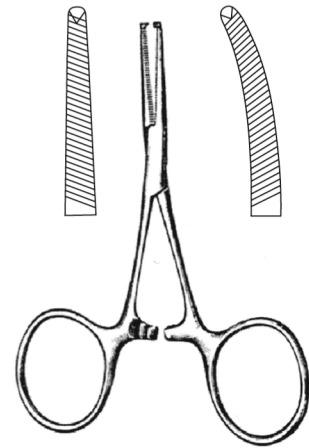

TERRIER
14.0048.09 9.0cm 14.0049.09

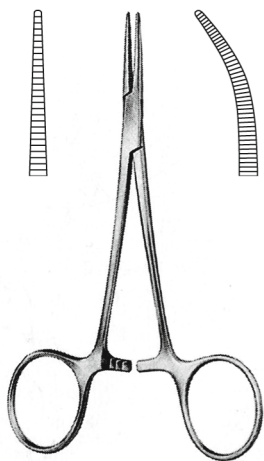

HALSTED-MOSQUITO
14.0060.12 12.5cm 14.0061.12
14.0060.14 14.0cm 14.0061.14

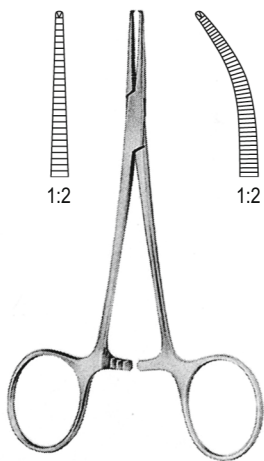

HALSTED-MOSQUITO
14.0062.12 12.5cm 14.0063.12
14.0062.14 14.0cm 14.0063.14

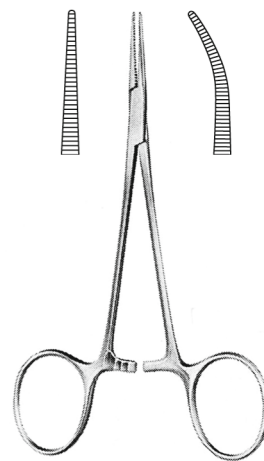

MICRO-MOSQUITO
14.0070.10 10.0cm 14.0071.10
14.0070.12 12.0cm 14.0071.12
14.0070.14 14.0cm 14.0071.14

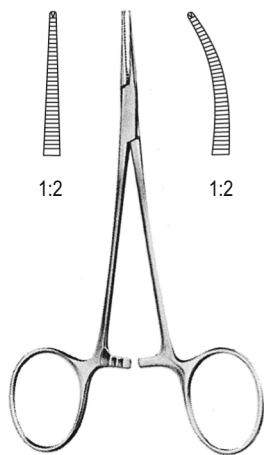

MICRO-MOSQUITO
14.0072.10 10.0cm 14.0073.10
14.0072.12 12.0cm 14.0073.12
14.0072.14 14.0cm 14.0073.14

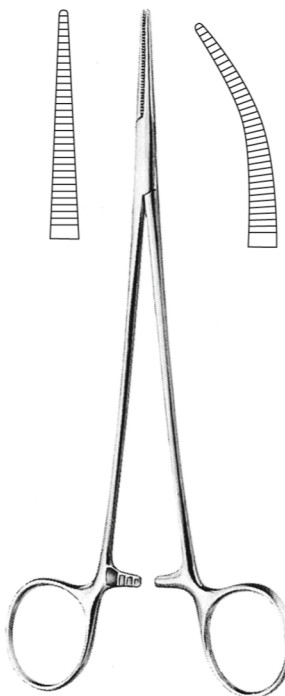

HALSTED-MOSQUITO
14.0080.16 16.0cm 14.0081.16
14.0080.18 18.0cm 14.0081.18
14.0080.21 21.0cm 14.0081.21

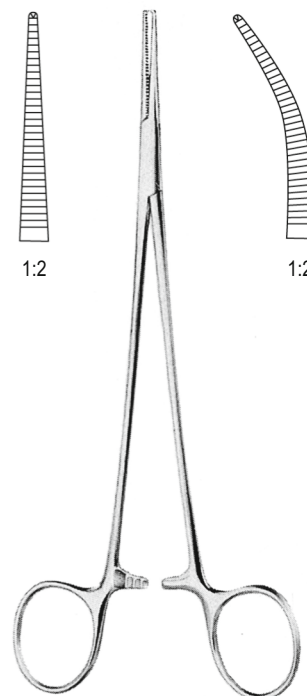

HALSTED-MOSQUITO
14.0082.16 16.0cm 14.0083.16
14.0082.18 18.0cm 14.0083.18
14.0082.21 21.0cm 14.0083.21

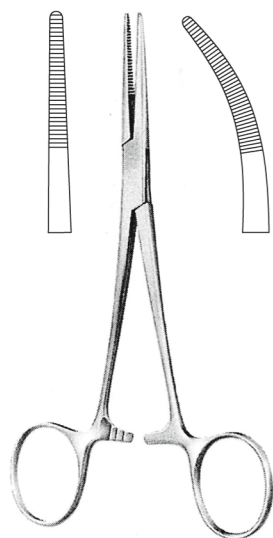

KELLY

14.0090.14 14.0cm 14.0091.14

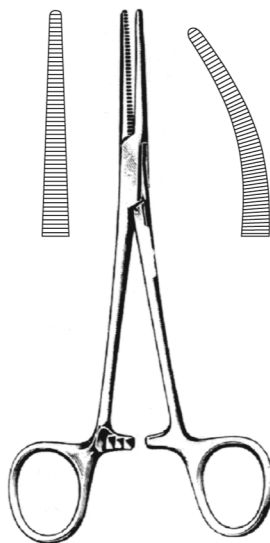

CRILE

14.0094.14 14.0cm 14.0095.14

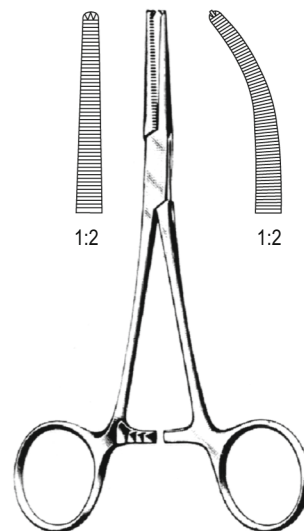

CRILE

14.0096.14 14.0cm 14.0097.14

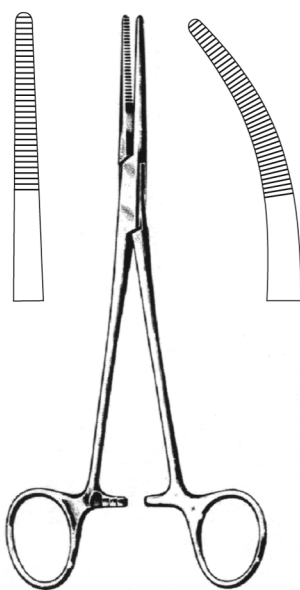

RANKIN-KELLY

14.0100.16 16.0cm 14.0101.16

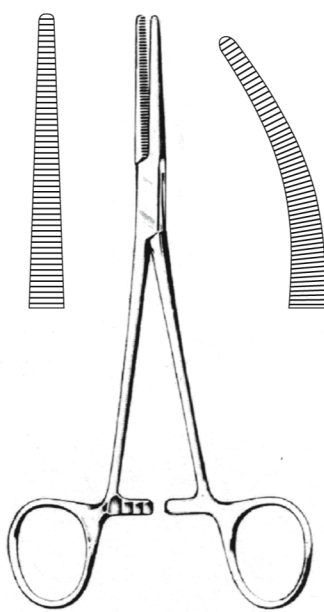

RANKIN-CRILE

14.0104.16 16.0cm 14.0105.16

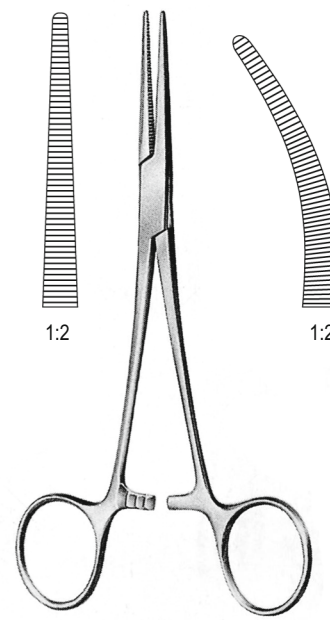

CRILE-RANKIN

14.0106.16 16.0cm 14.0107.16

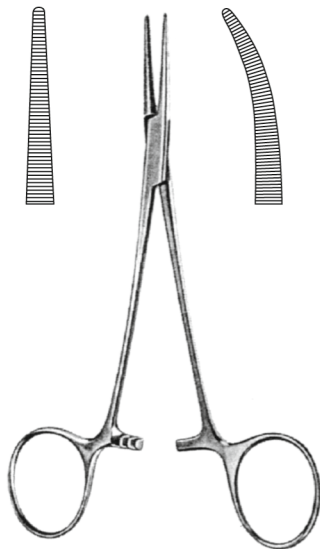

CRILE-DELICATE
14.0110.14 14.0cm 14.0111.14

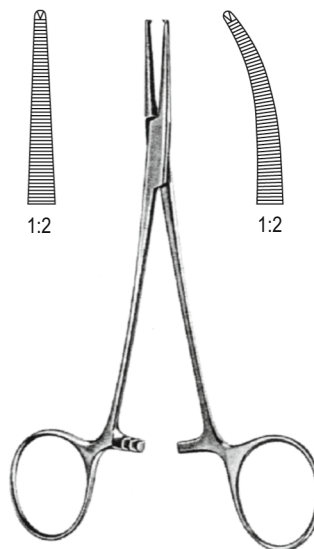

CRILE-DELICATE
14.0116.14 14.0cm 14.0117.14

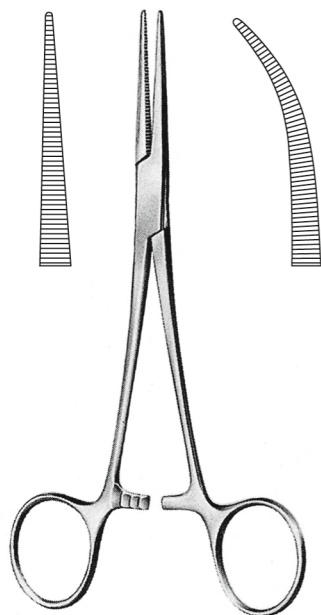

COLLER-CRILE
14.0120.14 14.0cm 14.0121.14
14.0120.16 16.0cm 14.0121.16

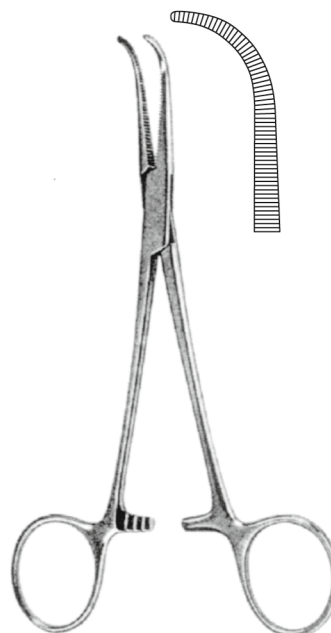

COLLER-CRILE
14.0126.16 16.0cm

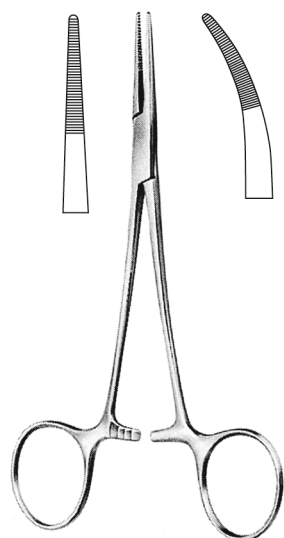

PROVIDENCE-HOSPITAL
14.0130.14 14.0cm 14.0131.14

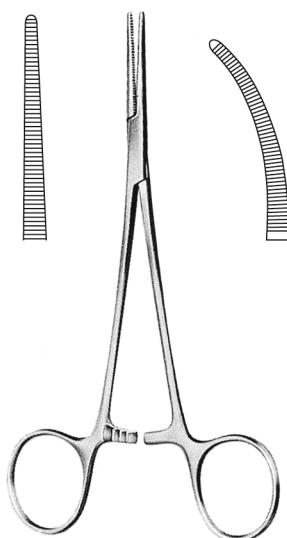

LERICHE
14.0136.15 15.0cm 14.0137.15

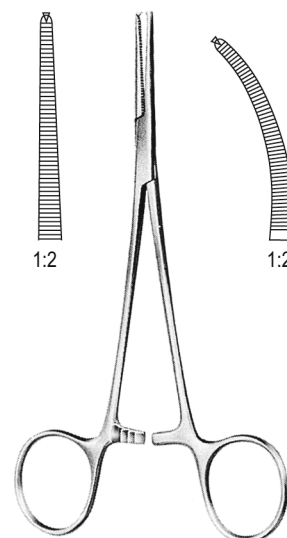

LERICHE
14.0138.15 15.0cm 14.0139.15

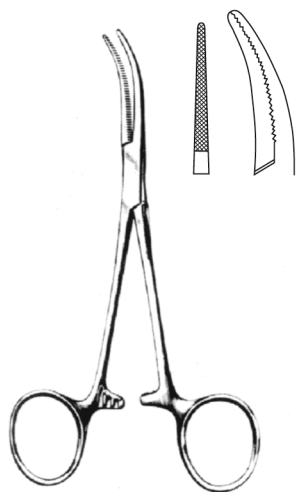

BABY-DANDY
14.0140.12 12.0cm

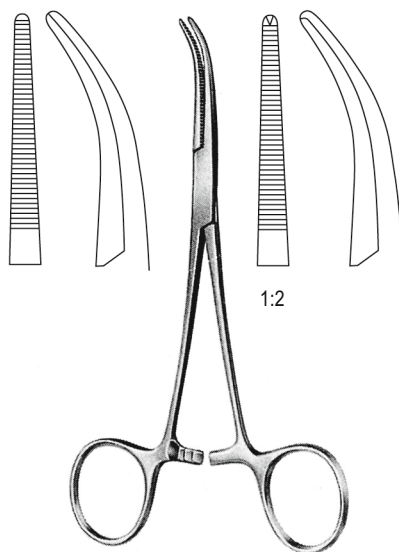

DANDY
14.0142.14 14.0cm 14.0144.14

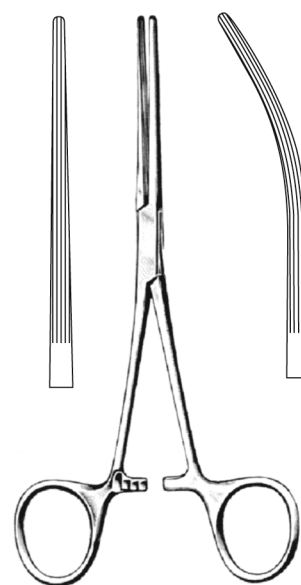

BAINBRIDGE
14.0150.15 15.0cm 14.0151.15
14.0150.18 18.5cm 14.0151.18

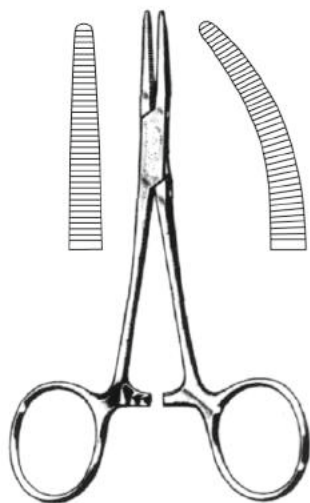

JONES

14.0156.12 12.5cm 14.0157.12
14.0156.15 15.0cm 14.0157.15

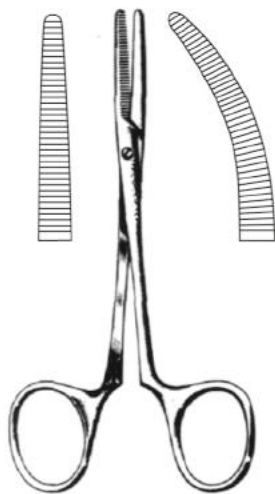

SPENCER-WELLS

14.0160.12 12.5cm 14.0161.12
14.0160.15 15.0cm 14.0161.15
14.0160.18 18.0cm 14.0161.18
14.0160.20 20.0cm 14.0161.20
14.0160.23 23.0cm 14.0161.23

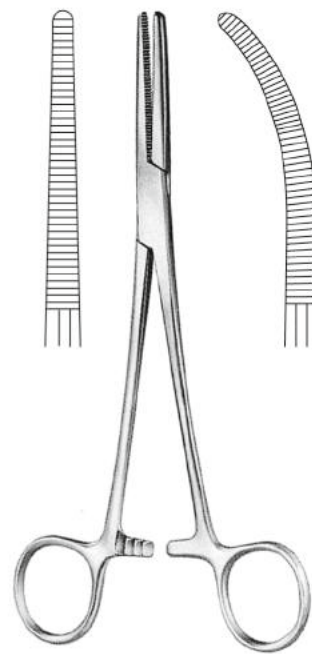

SPENCER-WELLS

14.0162.13 13.0cm 14.0163.13
14.0162.14 14.0cm 14.0163.14
14.0162.15 15.0cm 14.0163.15
14.0162.18 18.0cm 14.0163.18
14.0162.20 20.0cm 14.0163.20
14.0162.23 23.0cm 14.0163.23

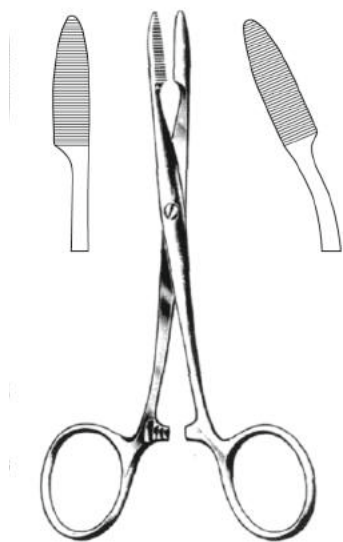

PEAN

14.0170.12 12.5cm 14.0171.12
14.0170.14 14.0cm 14.0171.14
14.0170.16 16.0cm 14.0171.16

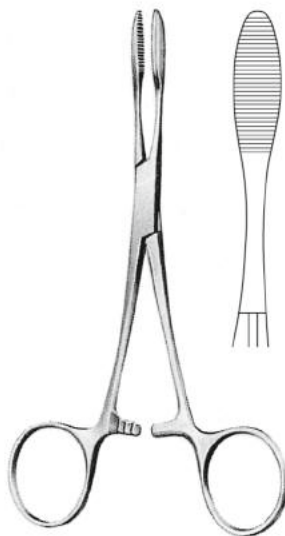

PEAN

14.0172.12 12.5cm
14.0172.14 14.0cm
14.0172.16 16.0cm

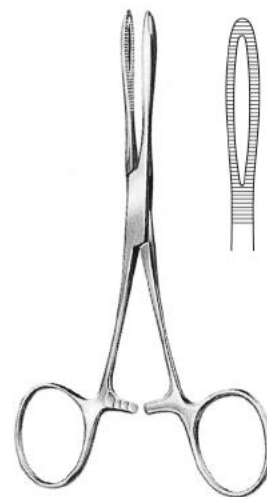

KROENLIËN

14.0176.14 14.0cm 14.0178.14

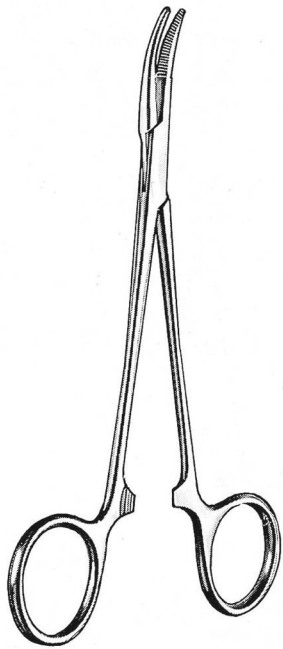

CAIRNS
14.0180.14 14.5cm 14.0181.14

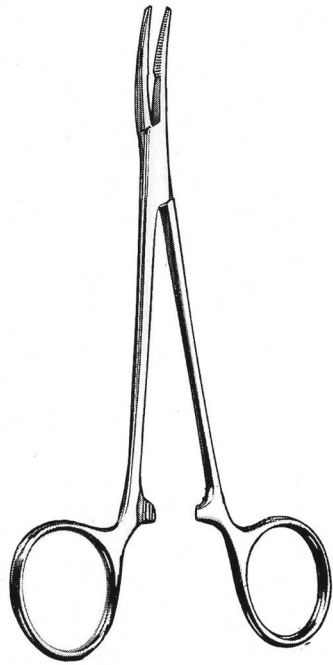

CUSHING
14.0186.14 14.0cm 14.0187.14

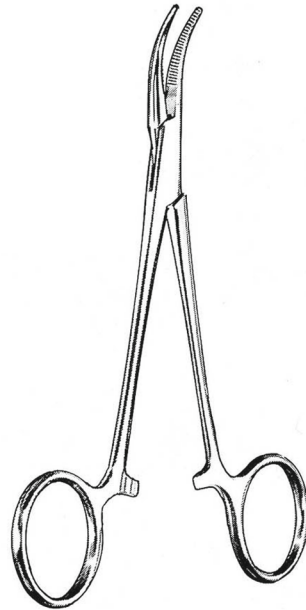

KILNER
14.0190.14 14.0cm 14.0191.14

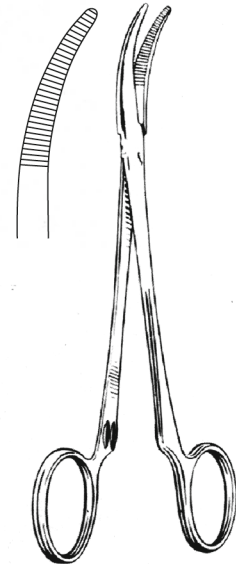

KELLY
14.0196.12 12.5cm

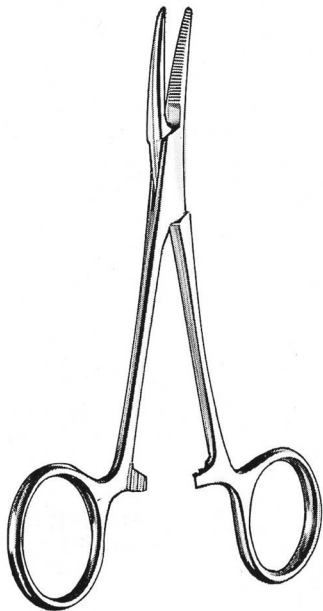

DUNHILL
14.0200.12 12.5cm 14.0201.12

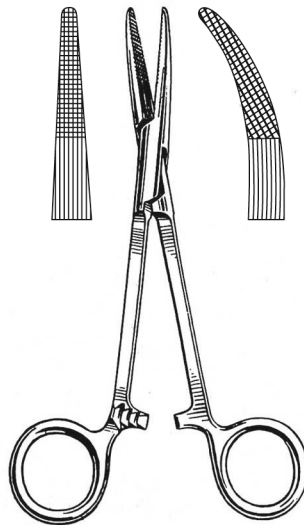

GREY-TURNER
14.0206.15 15.0cm 14.0207.15

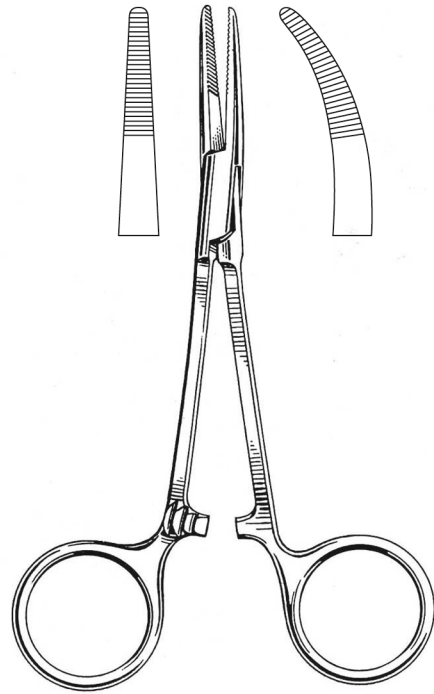

MOYNIHAN
14.0210.14 14.5cm 14.0211.14

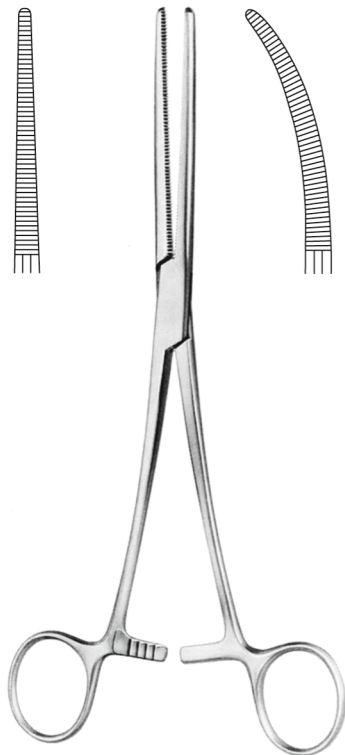

PEAN (ROCHESTER)

14.0220.13	13.0cm	14.0221.13
14.0220.14	14.0cm	14.0221.14
14.0220.16	16.0cm	14.0221.16
14.0220.18	18.0cm	14.0221.18
14.0220.20	20.0cm	14.0221.20
14.0220.22	22.0cm	14.0221.22
14.0220.24	24.0cm	14.0221.24
14.0220.26	26.0cm	14.0221.26
14.0220.28	28.0cm	14.0221.28
14.0220.30	30.0cm	14.0221.30

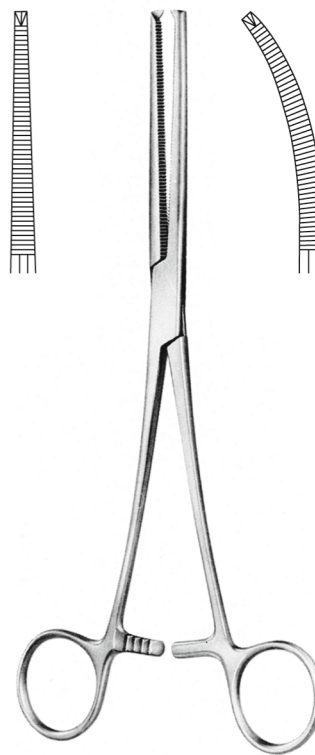

KOCHER (OCHSNER)

14.0226.13	13.0cm	14.0227.13
14.0226.14	14.0cm	14.0227.14
14.0226.16	16.0cm	14.0227.16
14.0226.18	18.0cm	14.0227.18
14.0226.20	20.0cm	14.0227.20
14.0226.22	22.0cm	14.0227.22
14.0226.24	24.0cm	14.0227.24
14.0226.26	26.0cm	14.0227.26
14.0226.28	28.0cm	14.0227.28
14.0226.30	30.0cm	14.0227.30

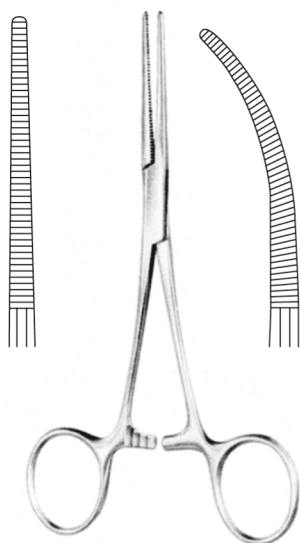

PEAN (DELICATE)

14.0230.13 13.0cm 14.0231.13
14.0230.14 14.0cm 14.0231.14
14.0230.16 16.0cm 14.0231.16

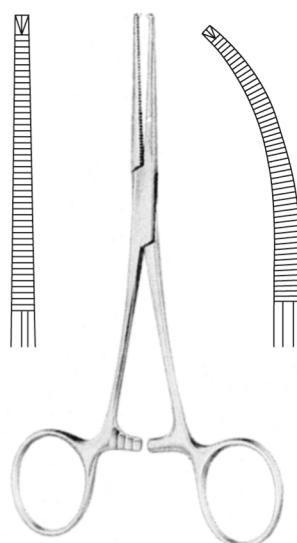

KOCHER (DELICATE)

14.0236.13 13.0cm 14.0237.13
14.0236.14 14.0cm 14.0237.14
14.0236.16 16.0cm 14.0237.16

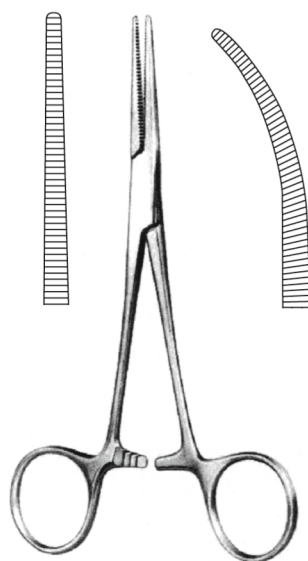

PEAN-NIPPON

14.0240.14 14.5cm 14.0241.14
14.0240.16 16.0cm 14.0241.16
14.0240.18 18.0cm 14.0241.18

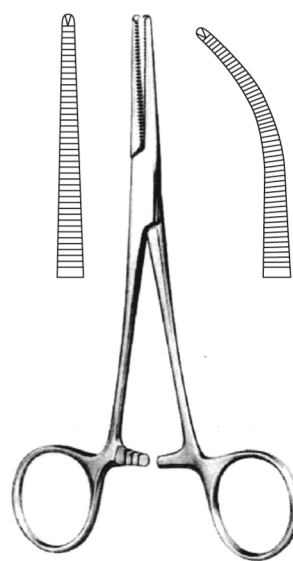

KOCHER-NIPPON

14.0246.14 14.5cm 14.0247.14
14.0246.16 16.0cm 14.0247.16
14.0246.18 18.0cm 14.0247.18

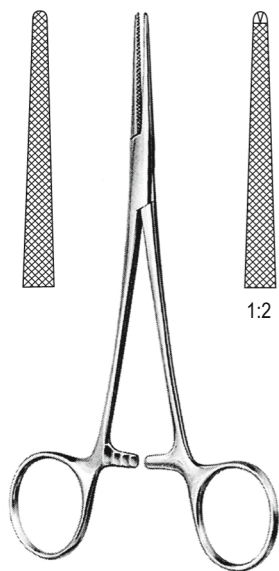

LOVELACE
14.0250.15 15.5cm 14.0252.15

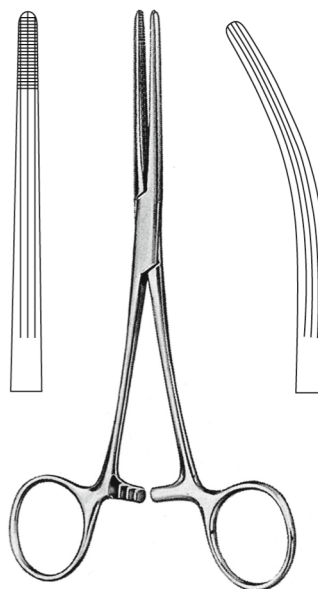

ROCHESTER-CARMALT
14.0256.16 16.0cm 14.0257.16
14.0256.20 20.0cm 14.0257.20



HOSEMANN
14.0260.21 21.0cm 14.0262.21



ADSON
14.0270.18 18.5cm 14.0271.18

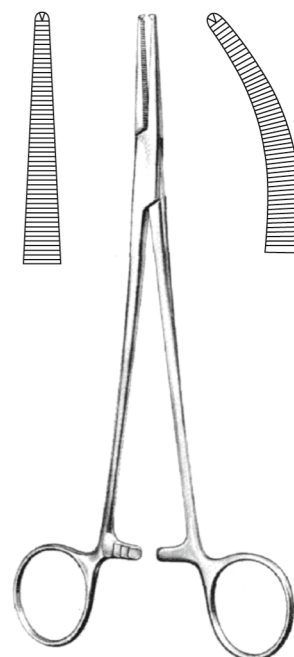

ADSON
14.0272.18 18.5cm 14.0273.18

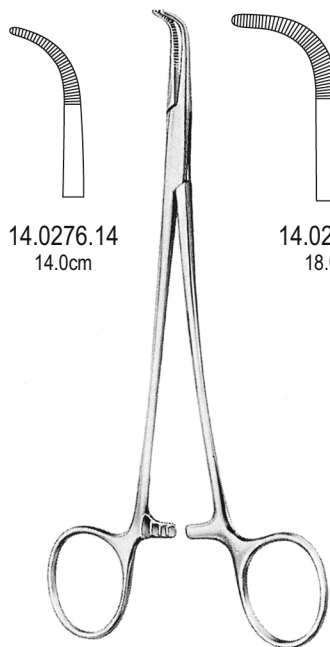

14.0276.14
14.0cm

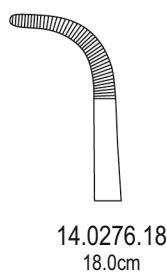

14.0276.18
18.0cm

BABY-ADSON



14.0280.12 12.0cm

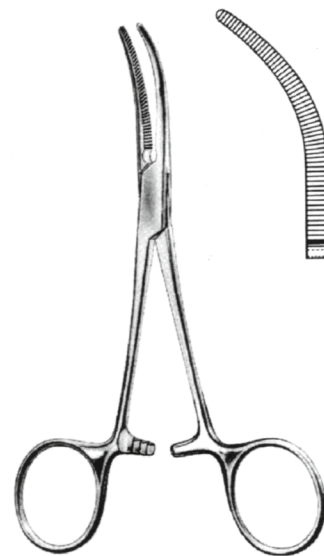

BABY-OVERHOLT
14.0290.13 13.5cm

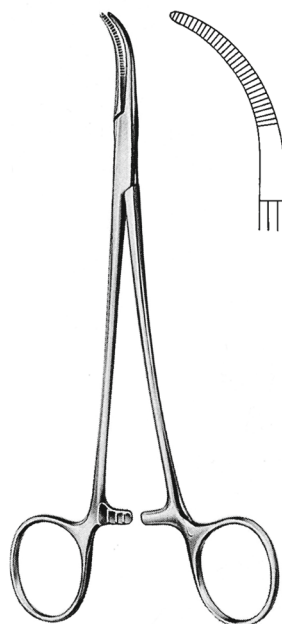

MIXTER BABY
14.0292.14 14.0cm

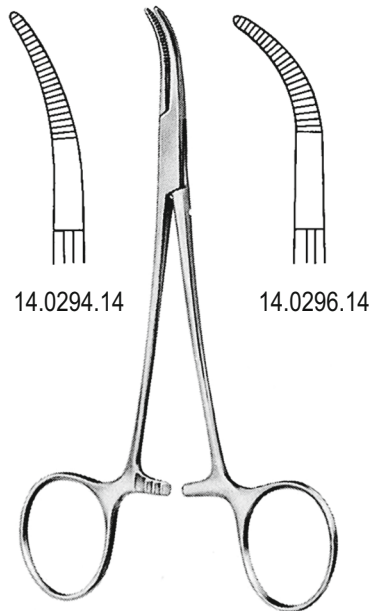

BABY-MIXTER
14.0cm

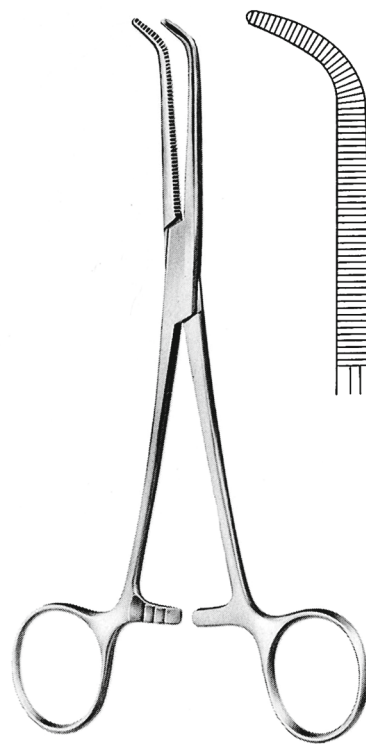

BABY-MIXTER
14.0298.18 18.0cm

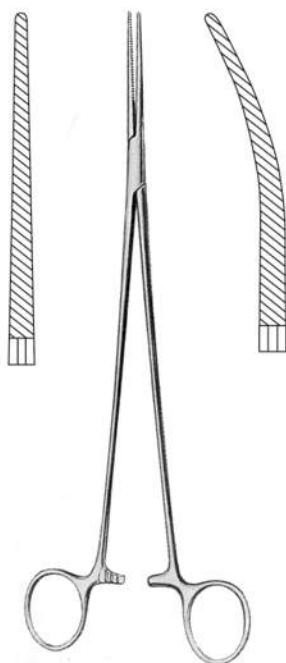

BENGOLEA

14.0300.20 20.0cm 14.0301.20
14.0300.24 24.0cm 14.0301.24
14.0300.26 26.0cm 14.0301.26

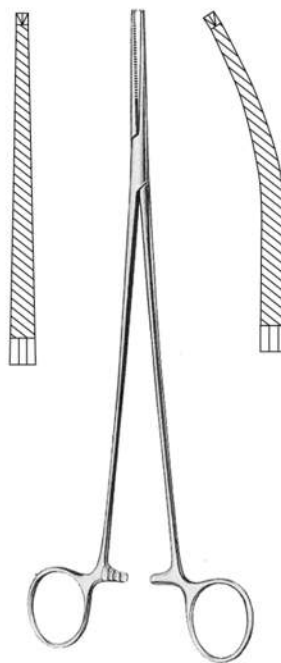

BENGOLEA

14.0302.20 20.0cm 14.0303.20
14.0302.24 24.0cm 14.0303.24
14.0302.26 26.0cm 14.0303.26

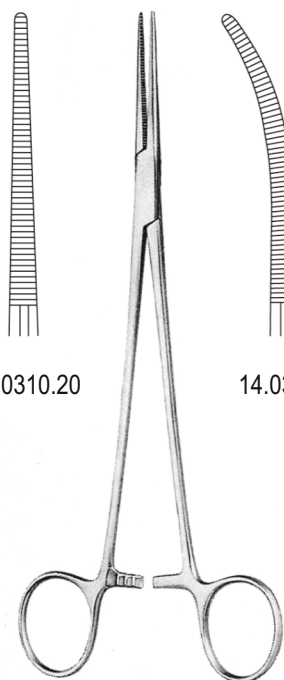

HEISS
20.0cm

14.0310.20

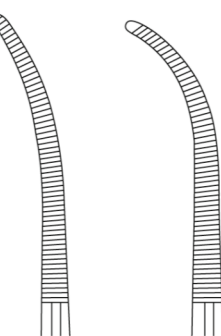

14.0311.20

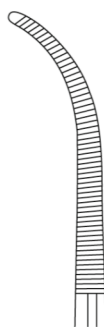

14.0313.20

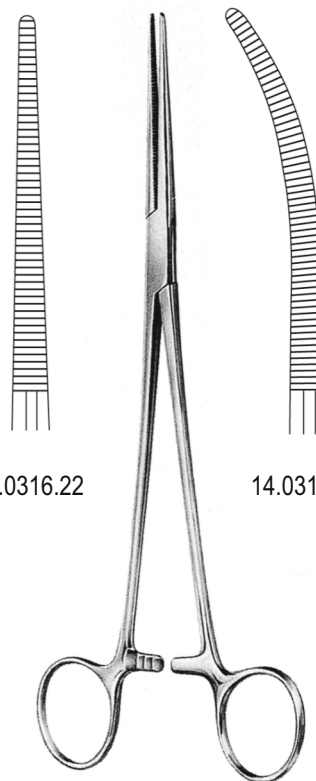

ROBERTS
22.0cm

14.0316.22



14.0317.22

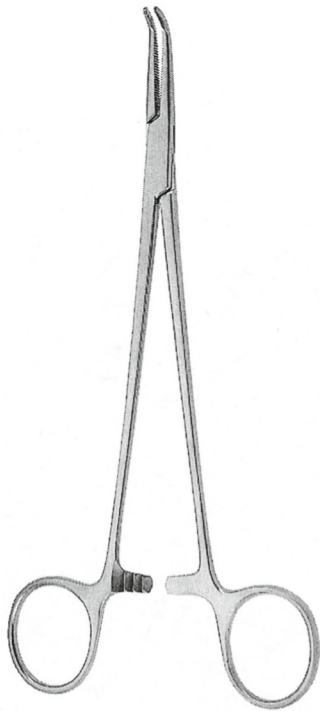

MINI-GEMINI

14.0320.18
18.0cm

14.0320.22
22.0cm

14.0320.25
25.0cm

14.0320.28
28.0cm

GEMINI

14.0322.13
13.0cm

14.0322.16
16.0cm

14.0322.18
18.0cm

14.0322.20
20.0cm

14.0322.23
23.0cm

14.0322.25
25.0cm

14.0322.28
28.0cm

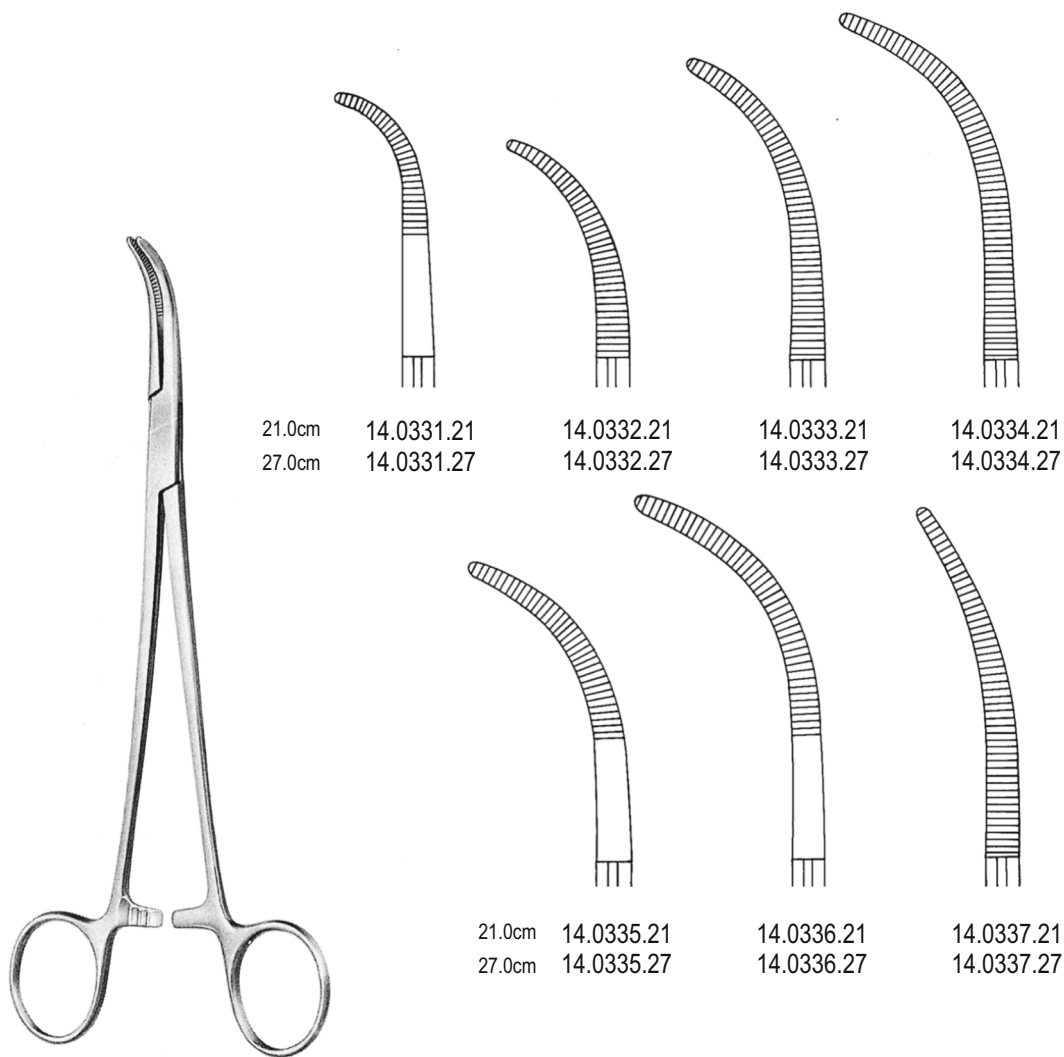

21.0cm	14.0331.21	14.0332.21	14.0333.21	14.0334.21
27.0cm	14.0331.27	14.0332.27	14.0333.27	14.0334.27

21.0cm	14.0335.21	14.0336.21	14.0337.21
27.0cm	14.0335.27	14.0336.27	14.0337.27

OVERHOLT-GEISSENDOERFER



OVERHOLT

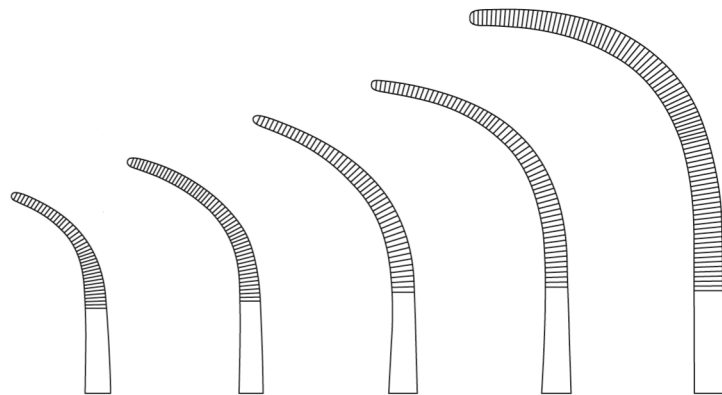

14.0340.01
18.5cm

14.0340.02
20.5cm

14.0340.03
21.0cm

14.0340.04
21.5cm

14.0340.05
24.0cm

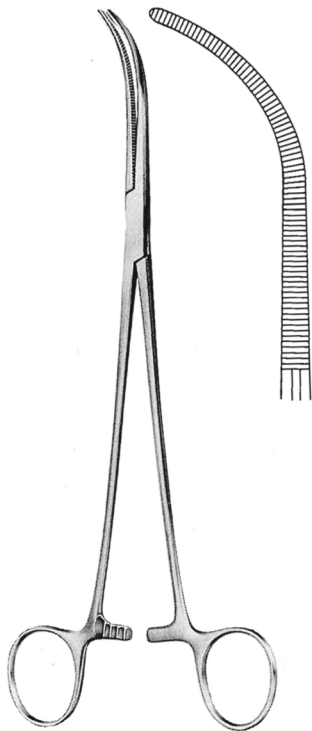

OVERHOLT-MIXTER
14.0342.21 21.0cm

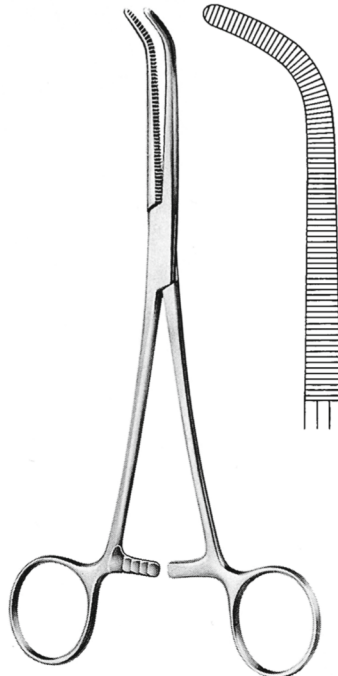

MIXTER
14.0344.22 22.0cm

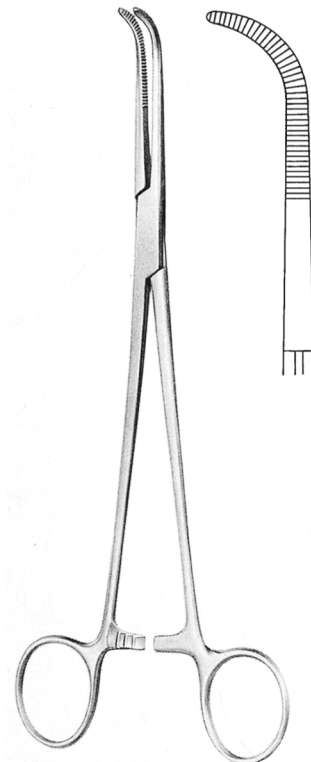

MIXTER
14.0346.23 23.0cm



KELLY

19.0 cm 14.0350.19 14.0351.19 14.0353.19
 22.0 cm 14.0350.22 14.0351.22 14.0353.22
 24.0 cm 14.0350.24 14.0351.24 14.0353.24

MEEKER

14.0356.27 27.5 cm

LAWRENCE

14.0358.27 27.5 cm

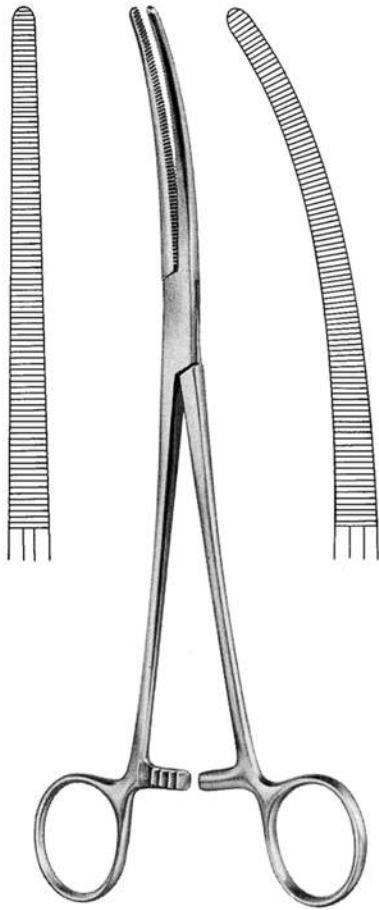

SAROT
14.0360.24 24.0cm 14.0361.24

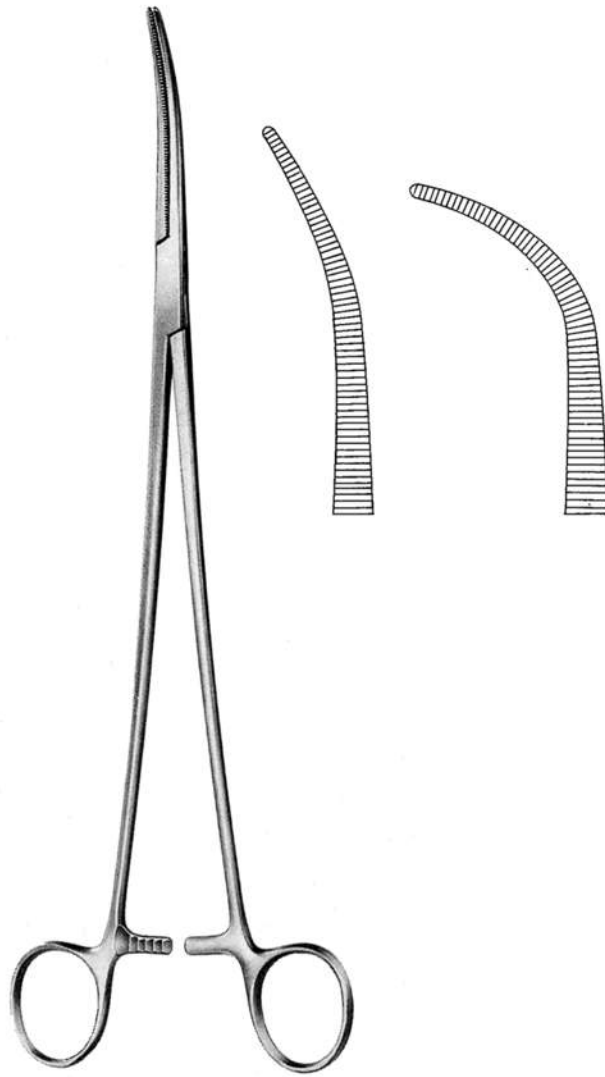

ZENKER
14.0366.01 29.5cm 140366.02

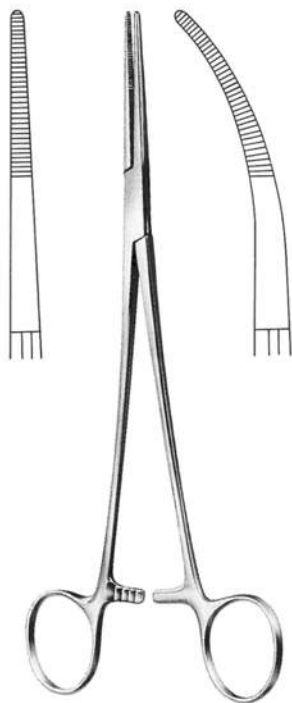

TOENNIS

14.0370.21 21.0cm 14.0371.21
14.0370.26 26.0cm 14.0371.26

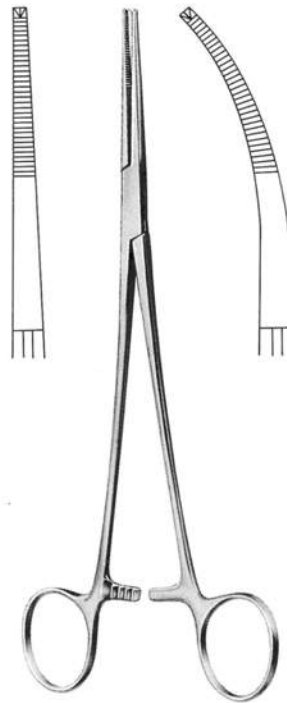

TOENNIS

14.0372.21 21.0cm 14.0373.21
14.0372.26 26.0cm 14.0373.26

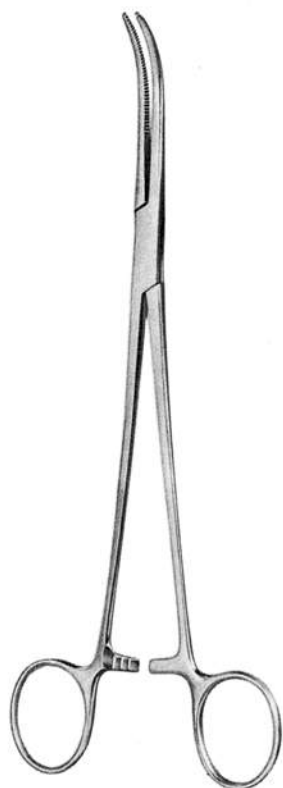

RUMEL
23.0cm

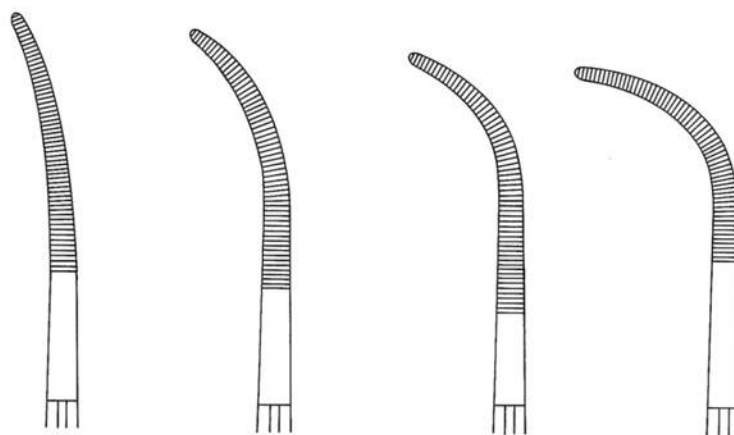

14.0380.01 14.0380.02 14.0380.03 14.0380.04 14.0380.05

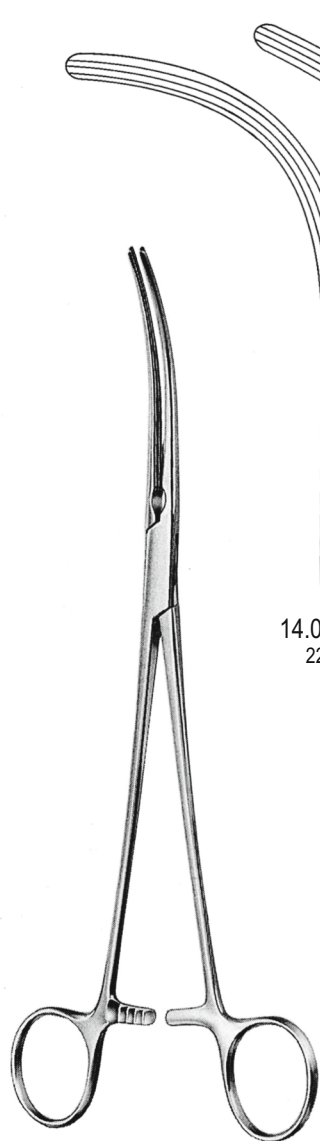

CRAFOORD-SELLORS

14.0386.01
22.0cm

14.0386.02
23.0cm

14.0386.03
24.0cm

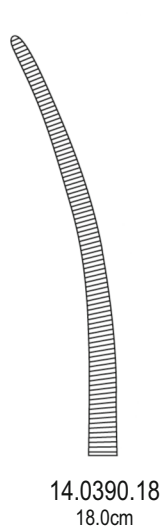

14.0390.18
18.0cm

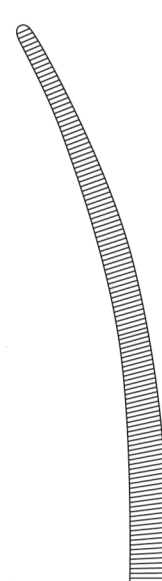

14.0390.24
24.0cm

CRAFOORD

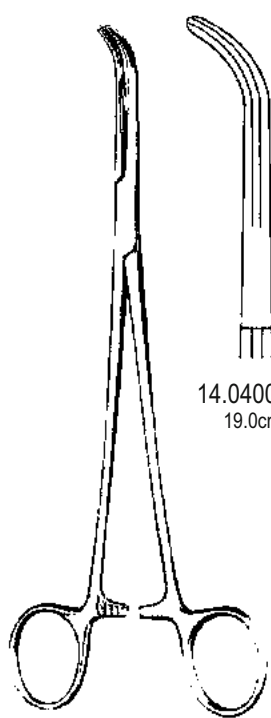

LAHEY

14.0400.19
19.0cm



14.0400.23
23.0cm

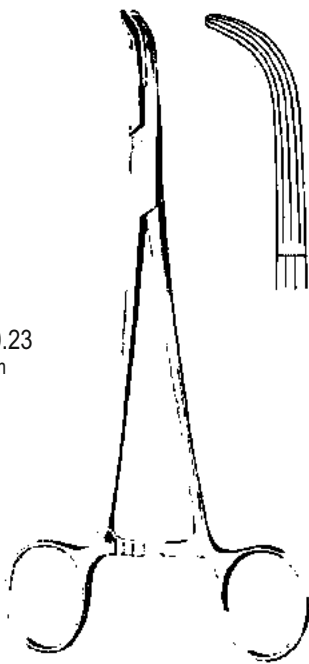

LOWER
14.0406.18 18.0cm

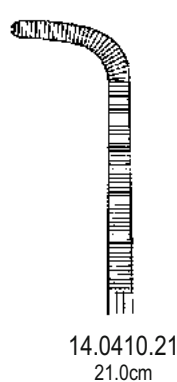

14.0410.21
21.0cm

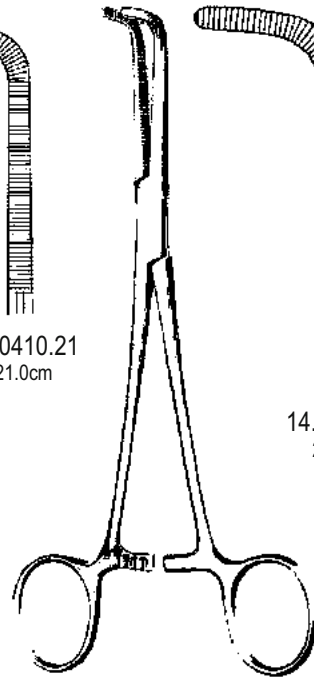

14.0410.24
24.0cm

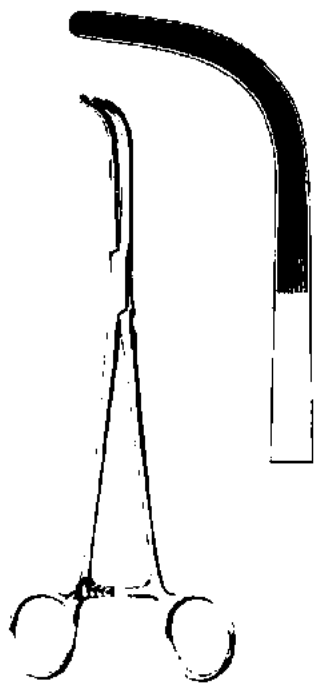

McQUIGG-MIXTER
14.0416.22 22.0cm

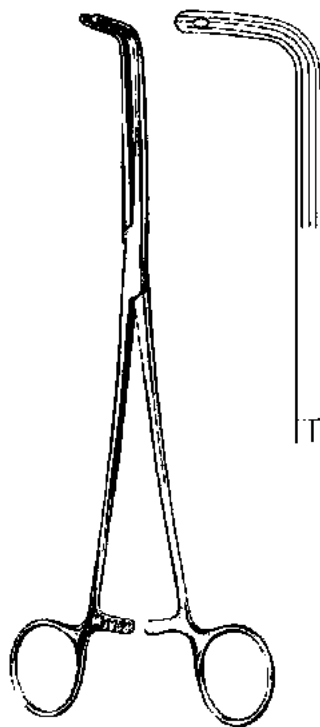

FINOCHIETTO
14.0420.24 24.0cm

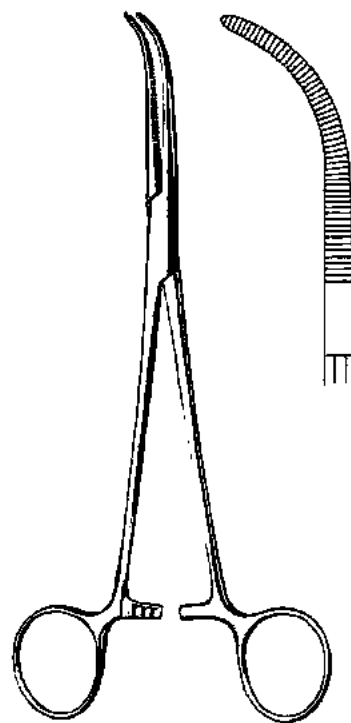

JOHNS HOPKINS
14.0426.20 20.0cm

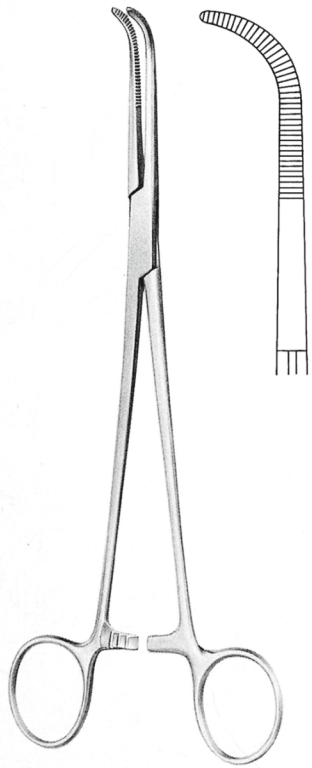

MIXTER
14.0430.15 15.0cm
14.0430.19 19.0cm

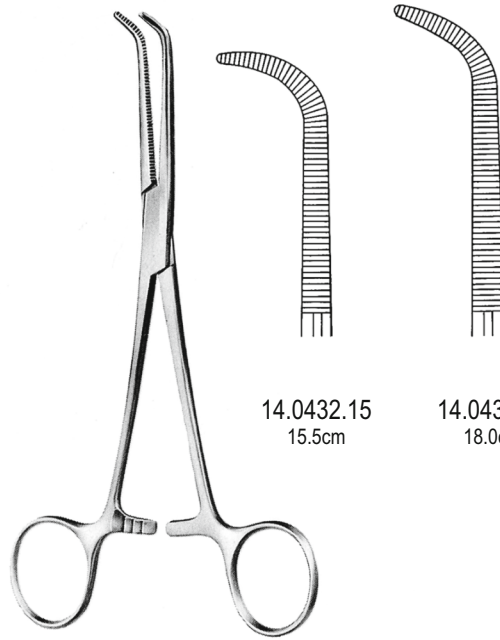

14.0432.15 15.5cm
14.0432.18 18.0cm

MIXTER

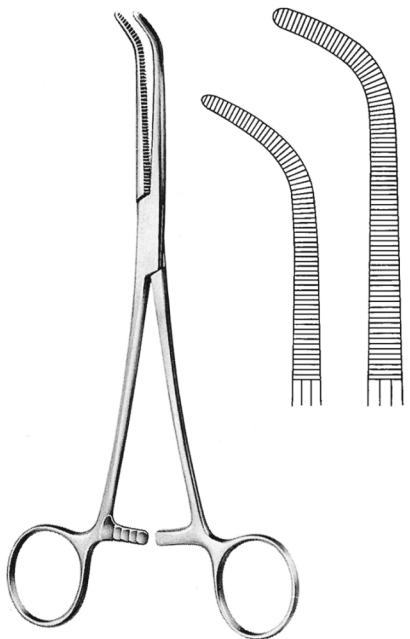

MIXTER-O'SHAUGNESSY
14.0434.18 18.0cm
14.0434.22 22.0cm

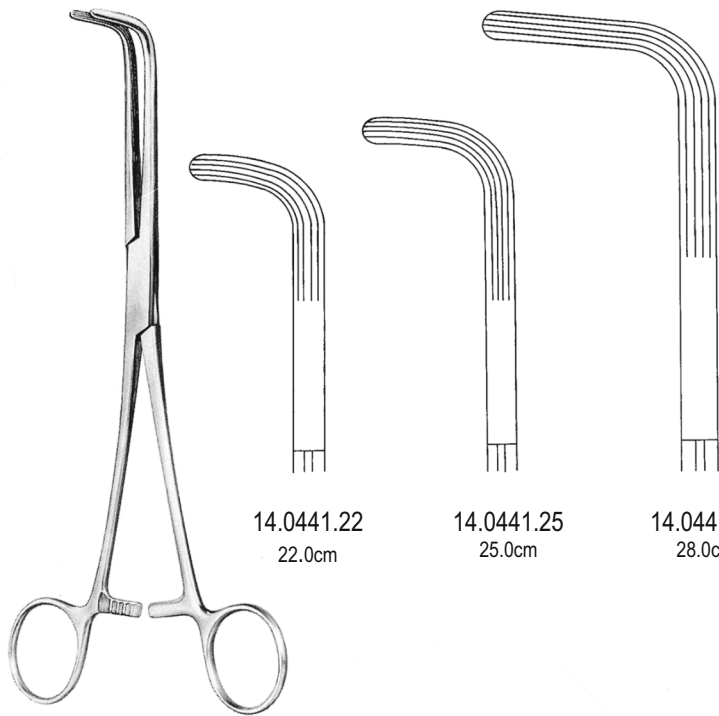

14.0441.22 22.0cm
14.0441.25 25.0cm
14.0441.28 28.0cm

MIXTER

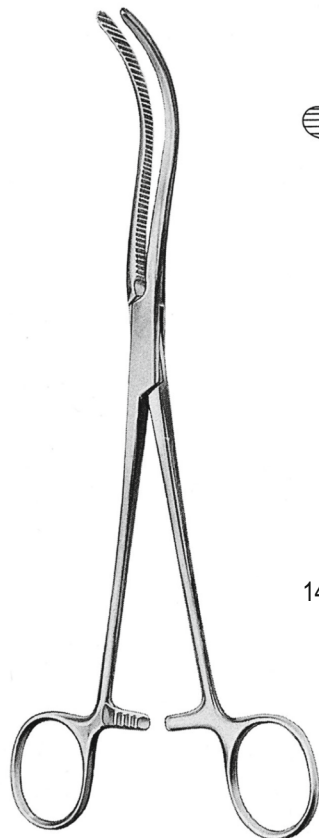

GUYON

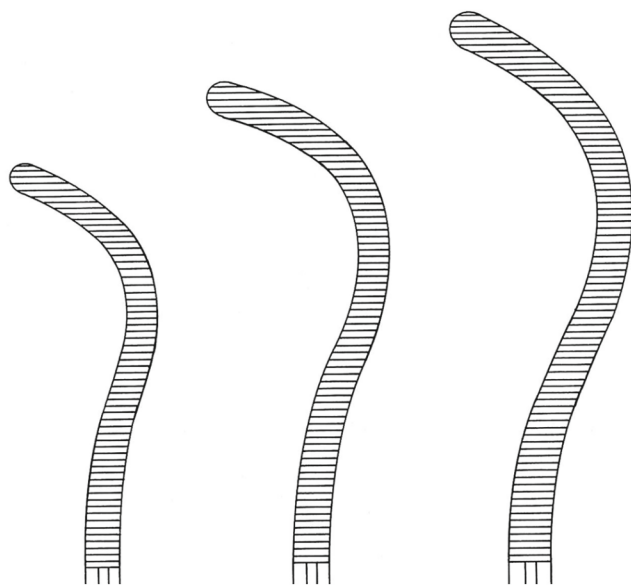

14.0450.20 20.0cm

14.0450.22 22.0cm

14.0450.24 24.0cm

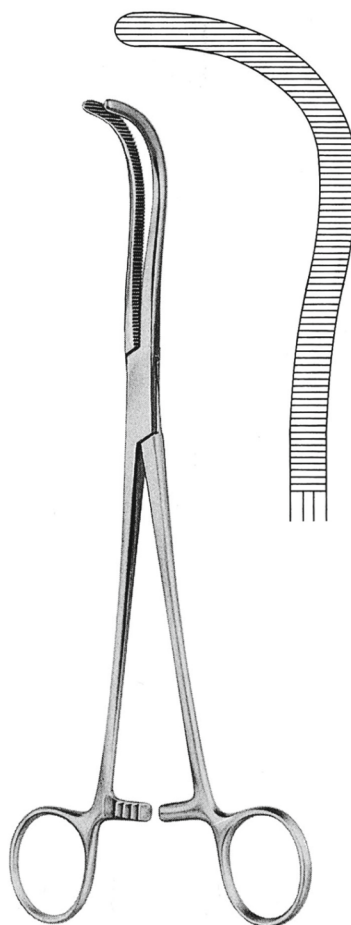

GUYON

14.0452.23 23.0cm

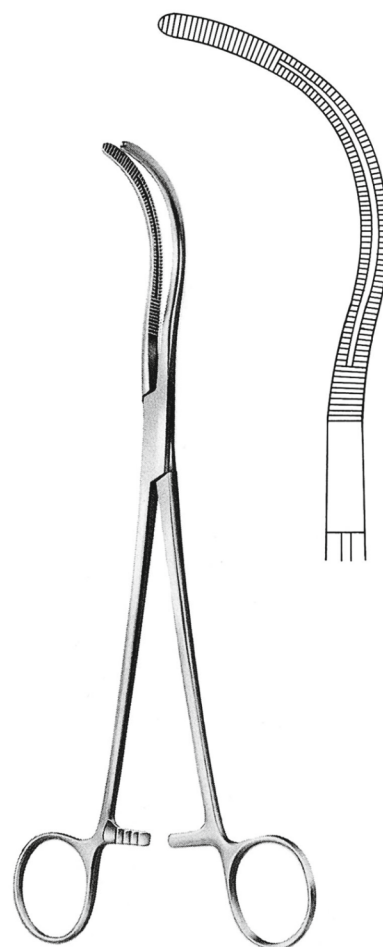

STILLE

14.0454.23 23.0cm

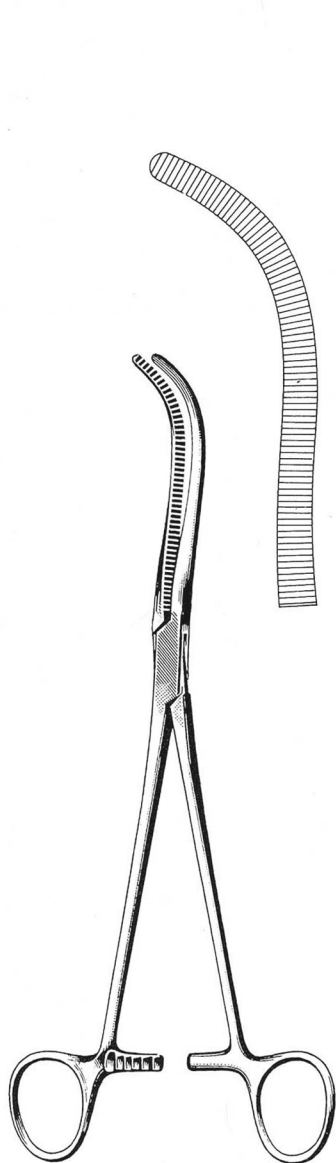

MAYO
14.0456.23 23.0cm

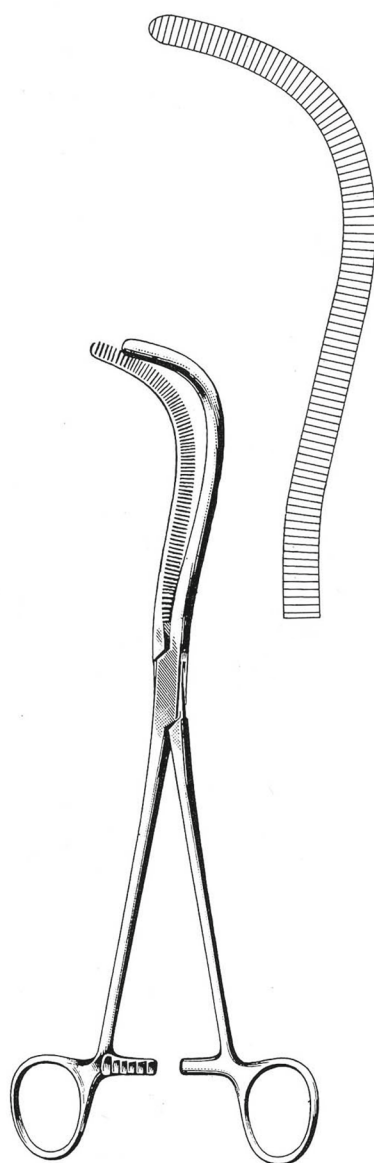

MAYO-GUYON
14.0458.23 23.0cm

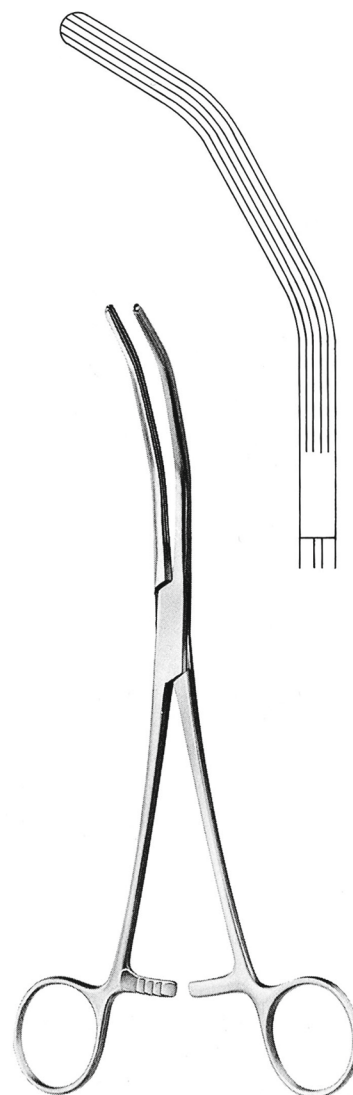

MAYO-GUYON
14.0460.23 23.0cm



GRAY

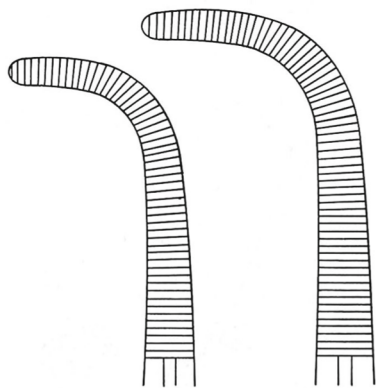

14.0464.22
22.0cm

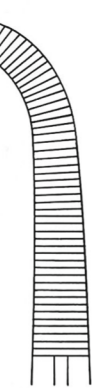

14.0464.23
23.0cm

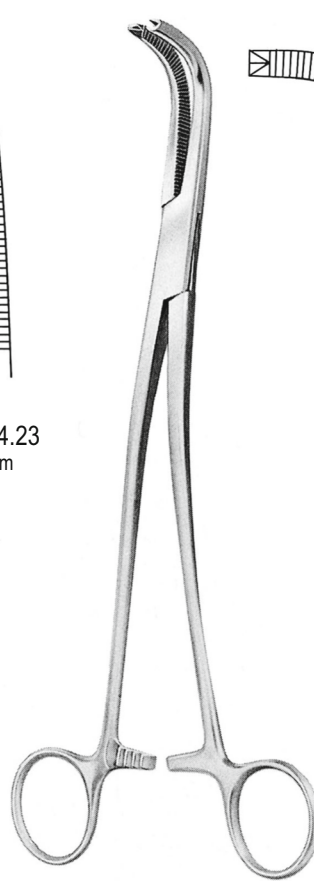

GRAY

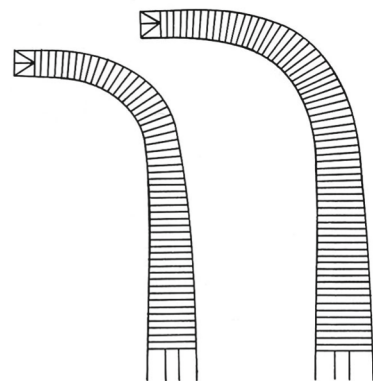

14.0468.22
22.0cm



14.0468.23
23.0cm



DESJARDINS
14.0470.21 21.0cm

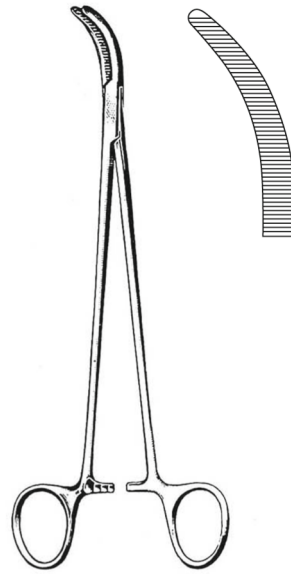

DESJARDINS
14.0472.21 21.0cm

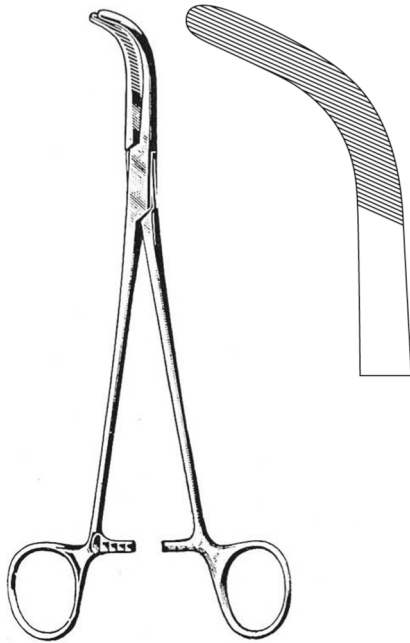

CRILE
14.0476.20 20.0cm



DEAN-SHALLCROSS
14.0480.18 18.0cm

АТРАУМА

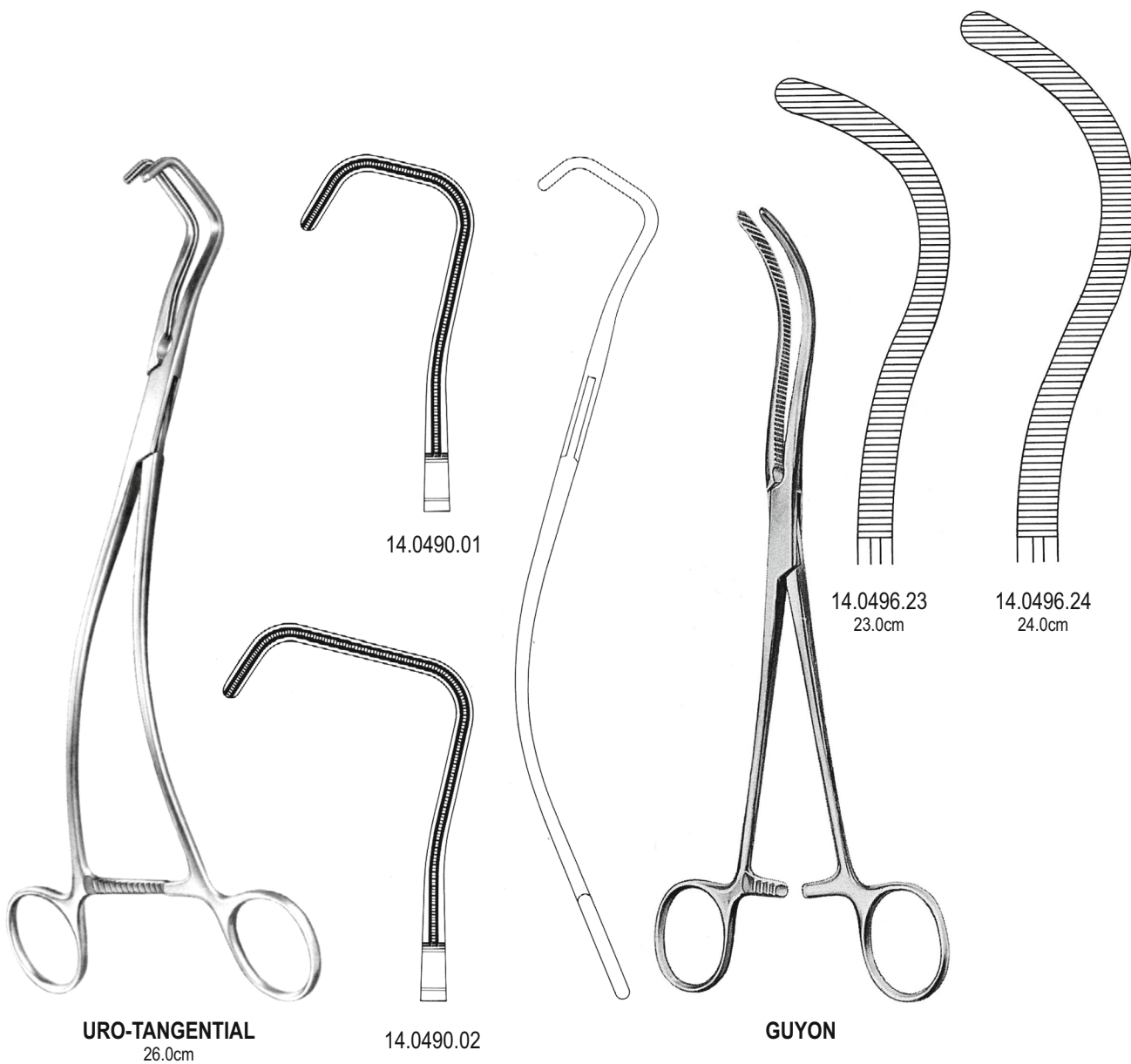



BABY-MIKULICZ
14.0500.14 14.0cm

MIKULICZ
14.0500.18 18.0cm

MIKULICZ
14.0500.20 20.0cm

MIKULICZ
14.0502.20 20.0cm

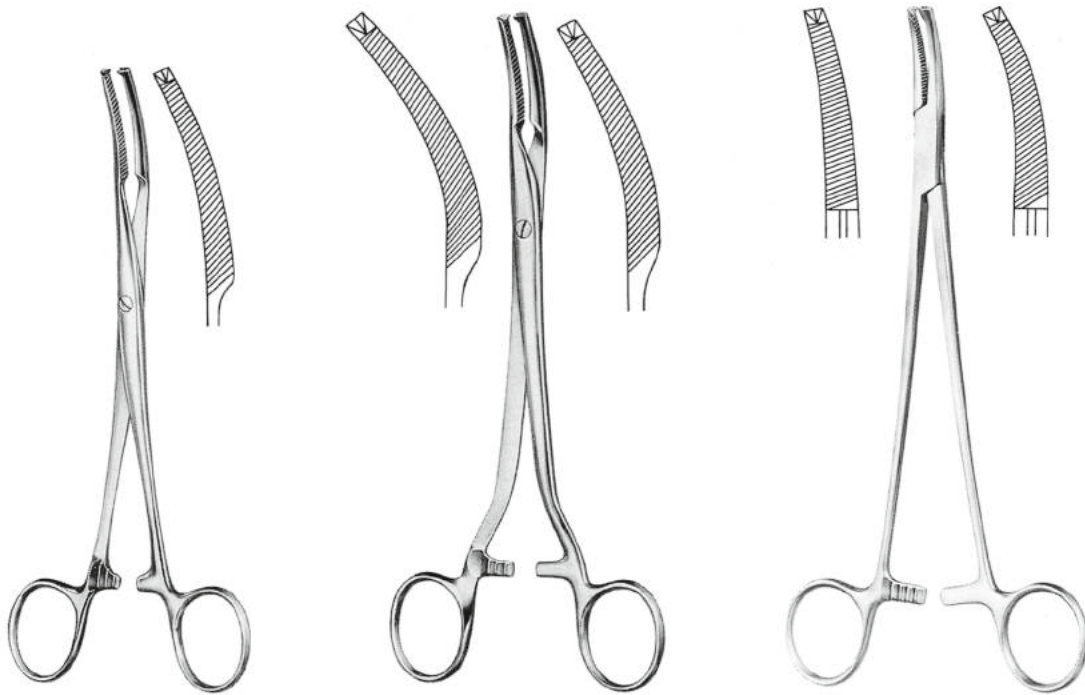

MIKULICZ
14.0504.18 18.0cm

MIKULICZ
14.0506.20 20.0cm 14.0508.20

FAURE
14.0512.20 20.0cm 14.0514.20

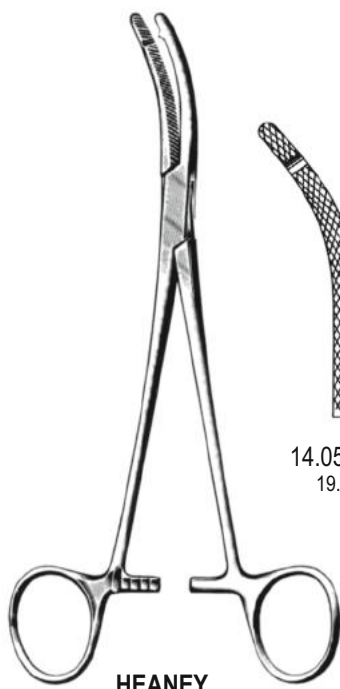

HEANEY

14.0520.19
19.5cm

14.0520.21
21.0cm

14.0520.23
23.0cm

14.0522.19
19.5cm

14.0522.21
21.0cm

14.0522.23
23.0cm

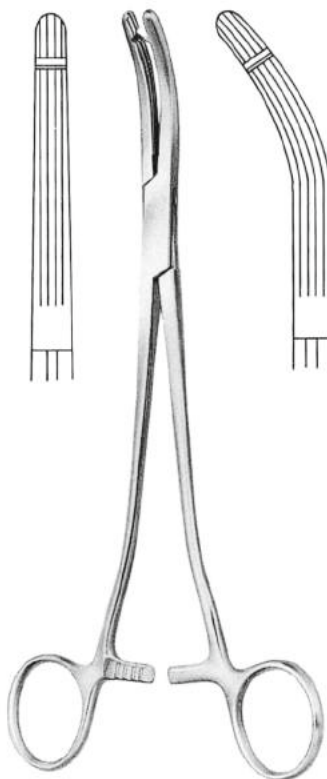

HEANEY-BALLENTINE
14.0526.21 21.0cm 14.0527.21

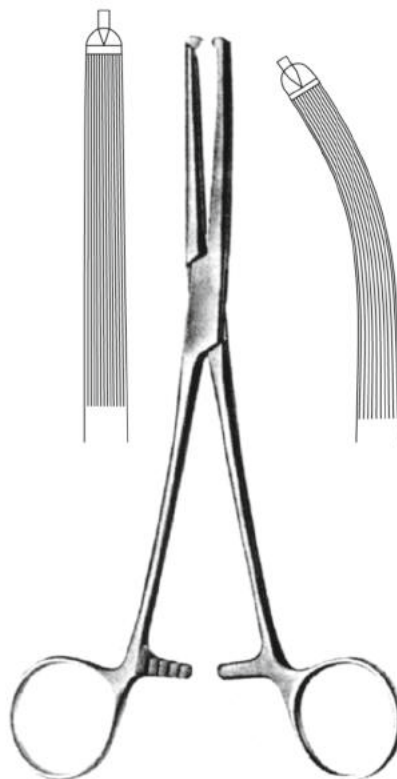

GWILLIAM
14.0530.20 20.0cm 14.0531.20

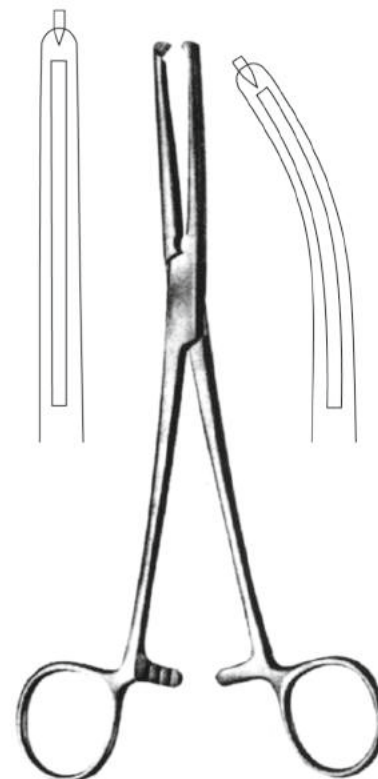

MAINGOT
14.0536.20 20.0cm 14.0537.20

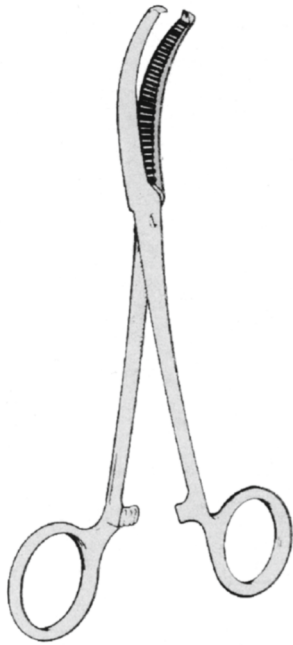

BERKELEY
14.0540.20 20.0 cm



BERKELEY BONNEY
14.0544.19 19.0 cm

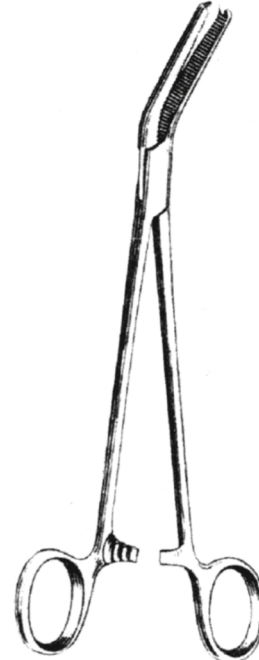

BONNEY
14.0548.20 20.5 cm

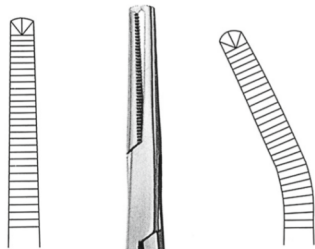

14.0550.21

14.0551.21

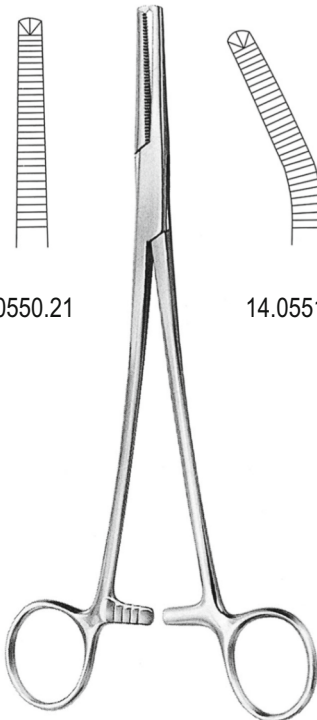

PHANEUF
21.0cm

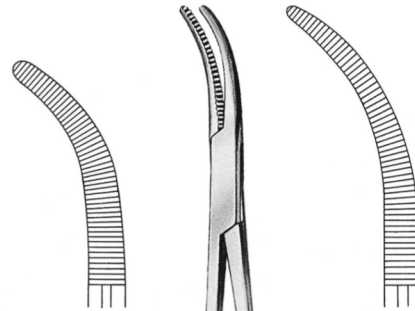

14.0556.23
23.0 cm

14.0556.24
24.0 cm

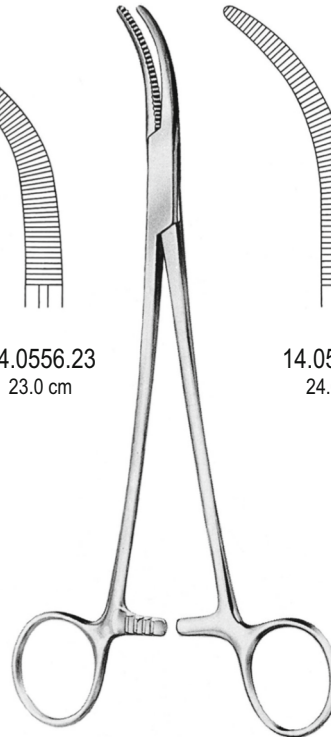

MOYNIHAN

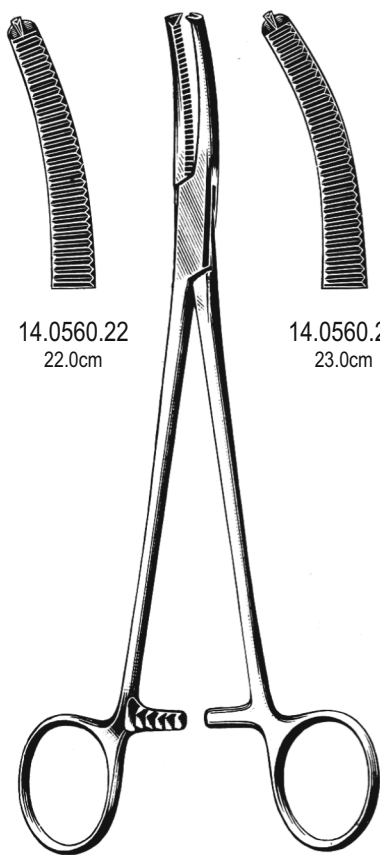

14.0560.22
22.0cm

WERTHEIM

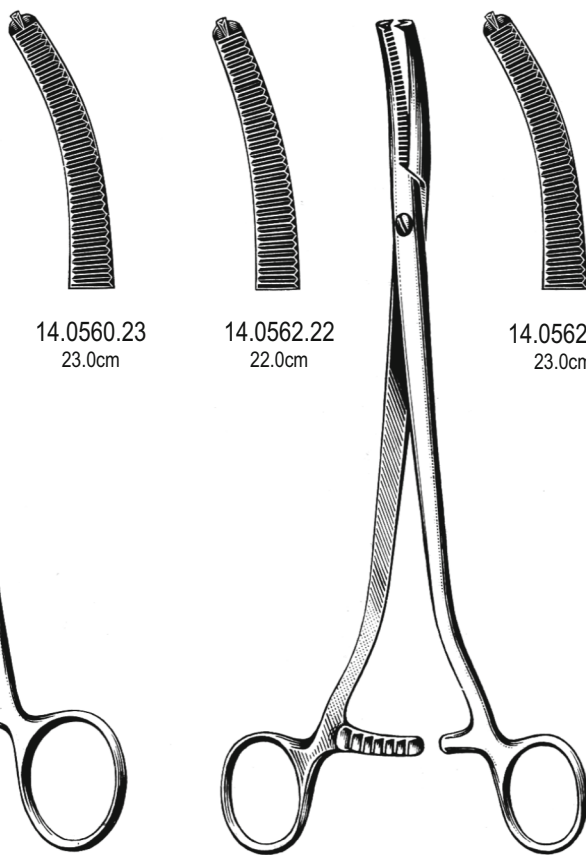

14.0560.23
23.0cm

WERTHEIM

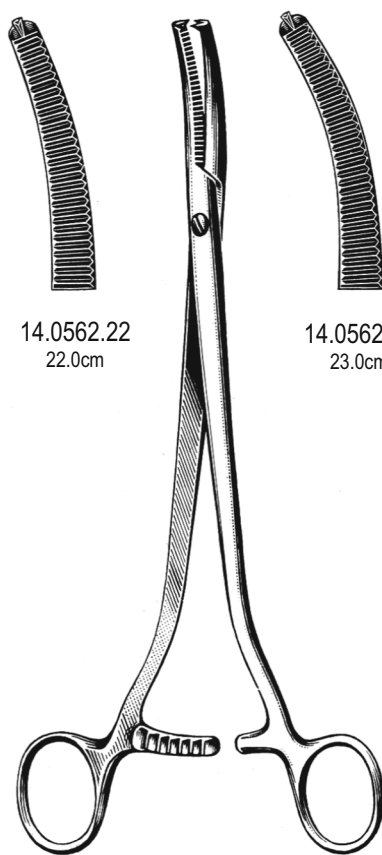

14.0562.22
22.0cm

14.0562.23
23.0cm

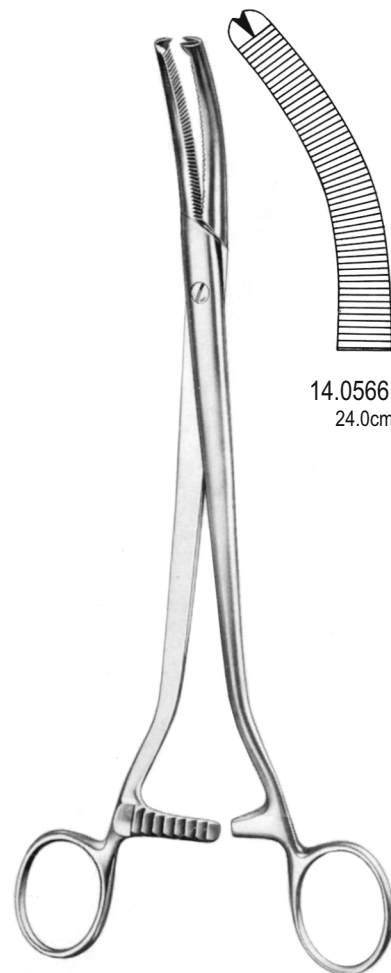

14.0566.24
24.0cm

WERTHEIM

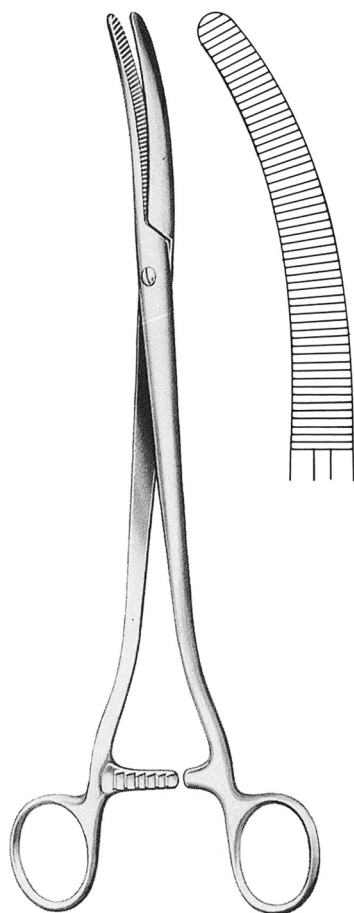

FAURE
14.0570.25 25.0cm

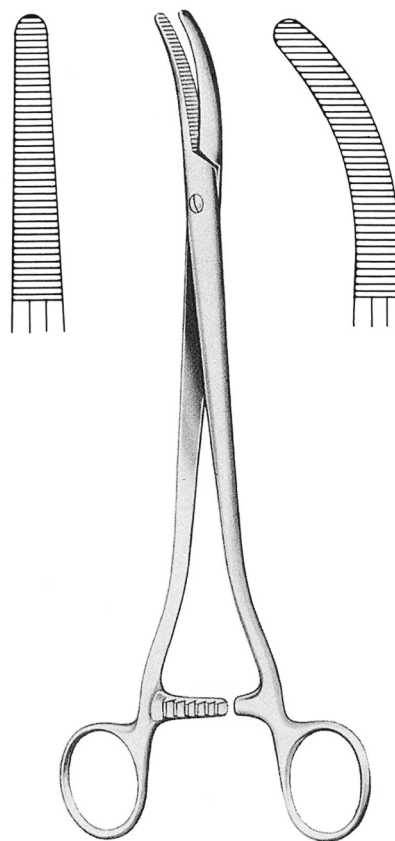

SEGOND-LANDAU
14.0576.24 24.0cm 14.0577.24

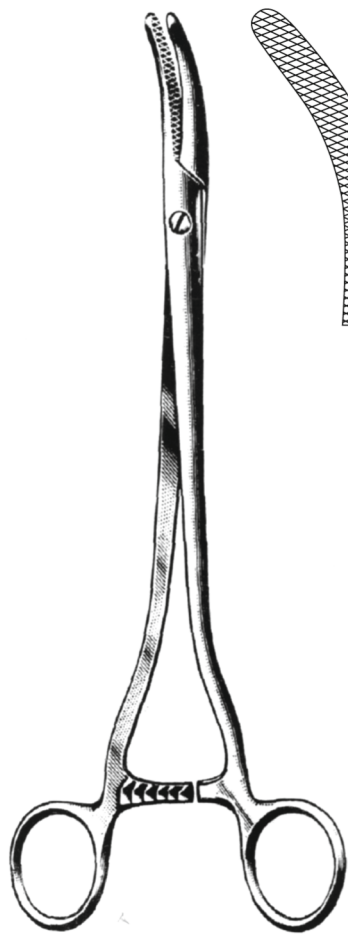

WERTHEIM
14.0580.25 25.0cm

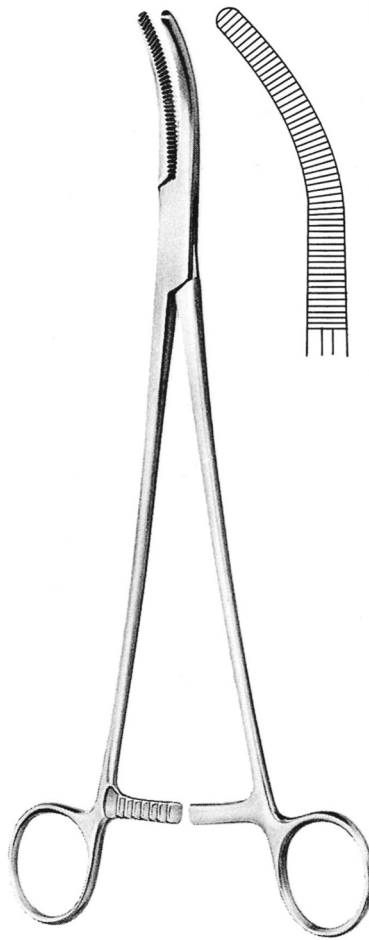

WERTHEIM
14.0582.25 25.0cm

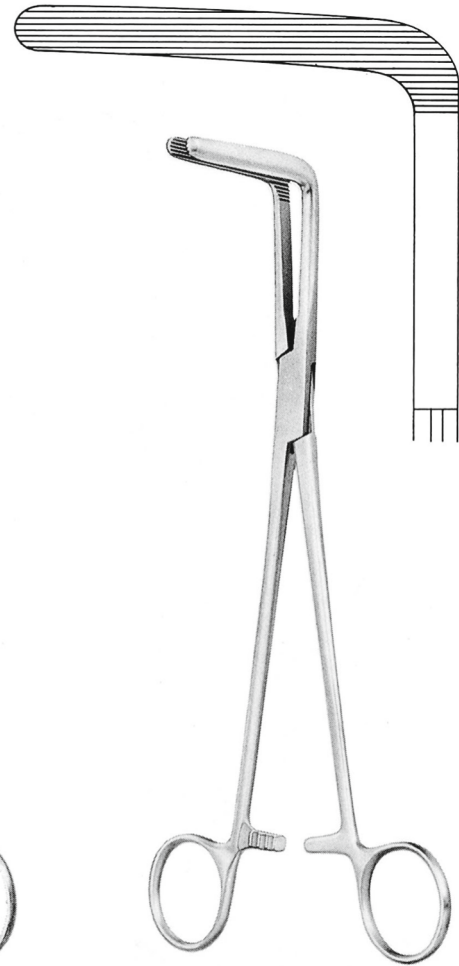

WERTHEIM-CULLEN
14.0586.21 21.5cm

АТРАУМА

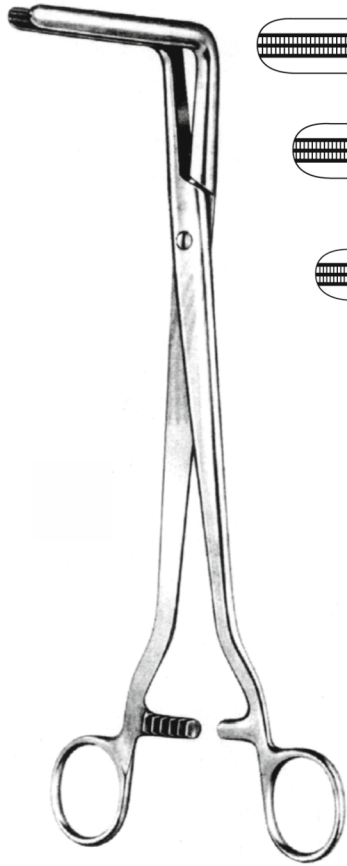

WERTHEIM
24.0cm

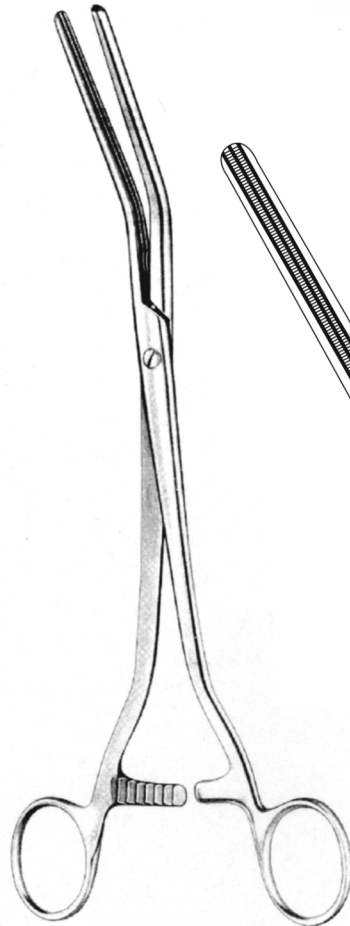
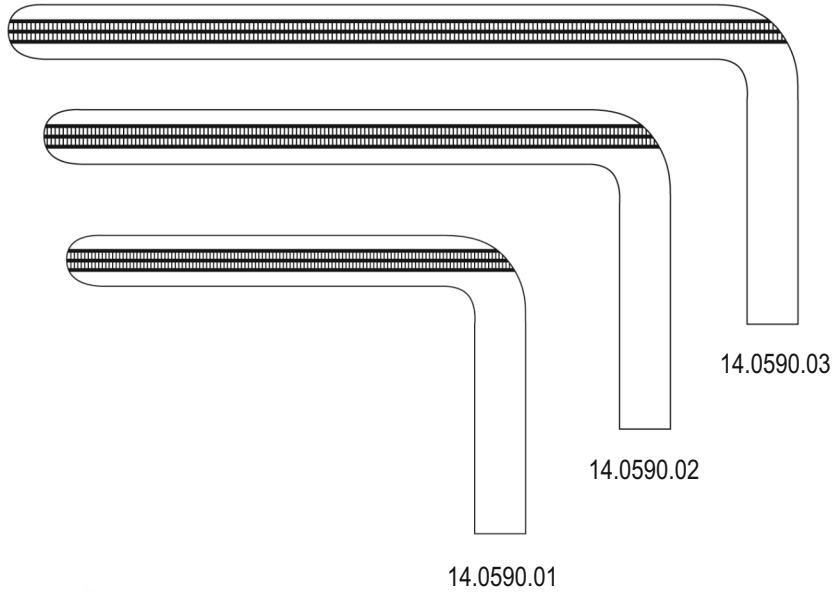

DICK

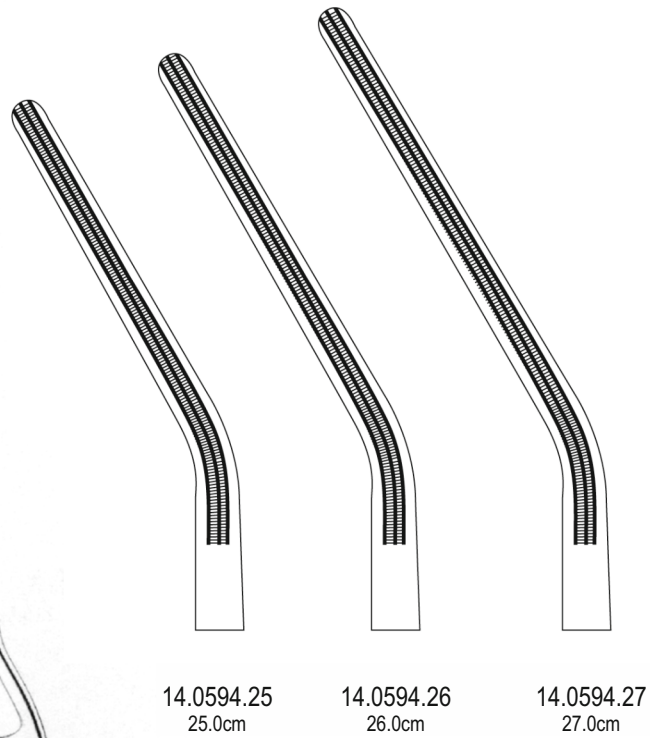

АТРАУМА



ROGERS

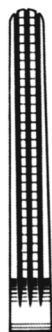

14.0600.01
22.0cm



14.0600.02
21.5cm



14.0600.03
21.0cm

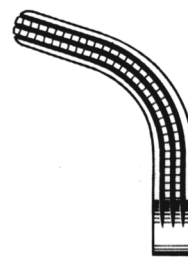

14.0600.04
20.5cm



14.0602.01
25.0cm



14.0602.02
25.0cm



14.0602.03
24.5cm

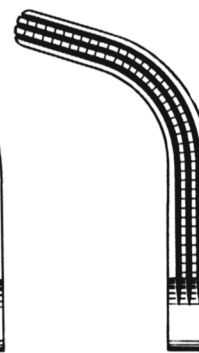

14.0602.04
23.0cm



MARTEL
 14.0620.14 14.0cm



PRATT
 14.0624.15 15.0cm

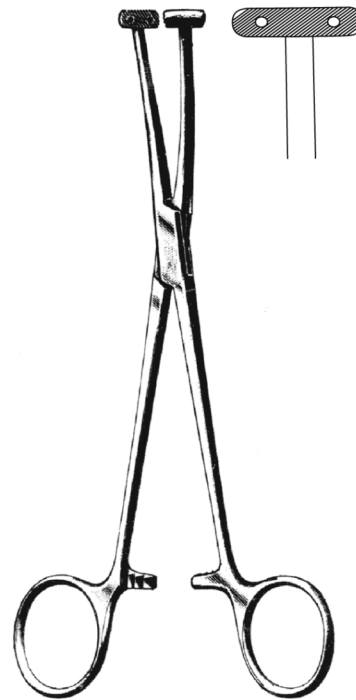

WILLET-MARTEL
 14.0628.19 19.0cm

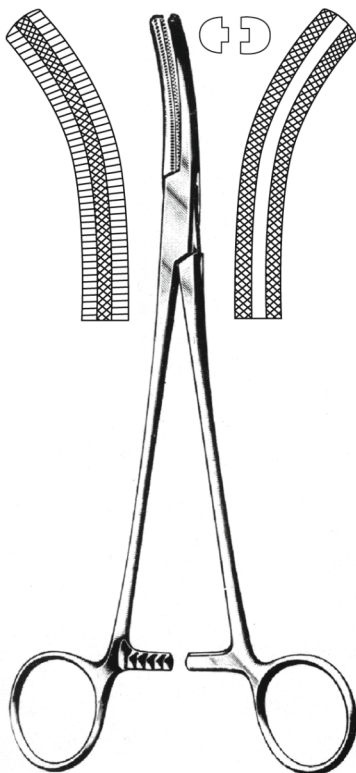

BUIE
 14.0630.21 21.0cm



FERGUSSON

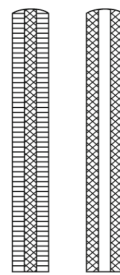

14.0636.16 16.0cm

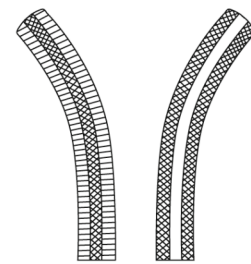

14.0637.16 16.0cm

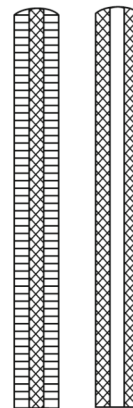

14.0636.20 20.0cm

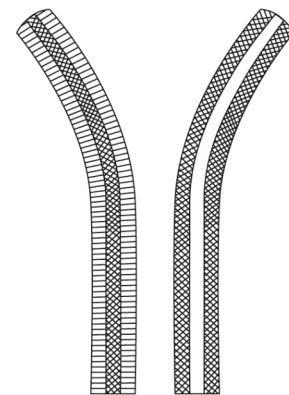

14.0637.20 20.0cm

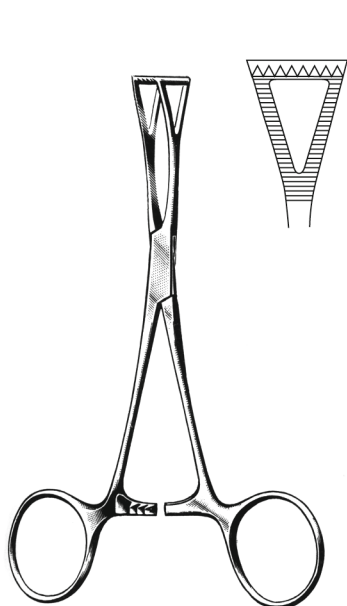

COLLIN
14.0640.14 14.0cm

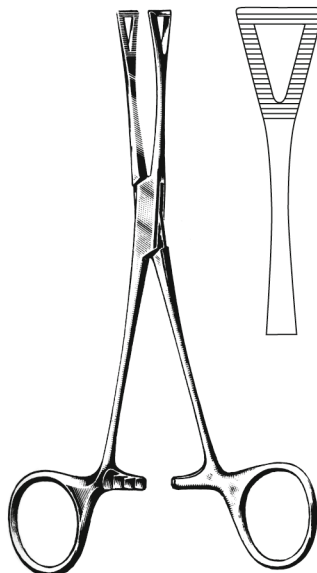
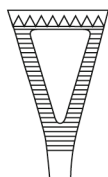

PENNINGTON
14.0646.15 15.5cm
14.0646.20 20.0cm

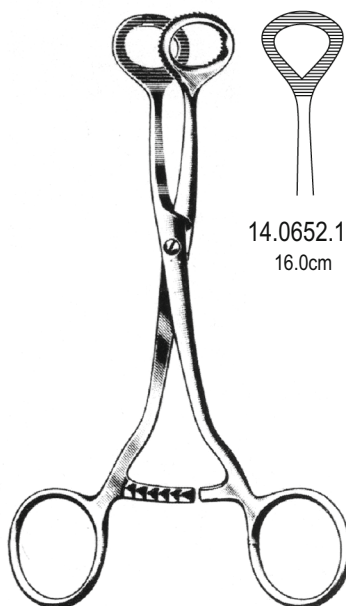

COLLIN
14.0650.16 16.0cm

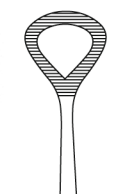

14.0652.16
16.0cm

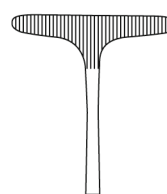

14.0654.16
16.0cm



14.0656.16
16.0cm

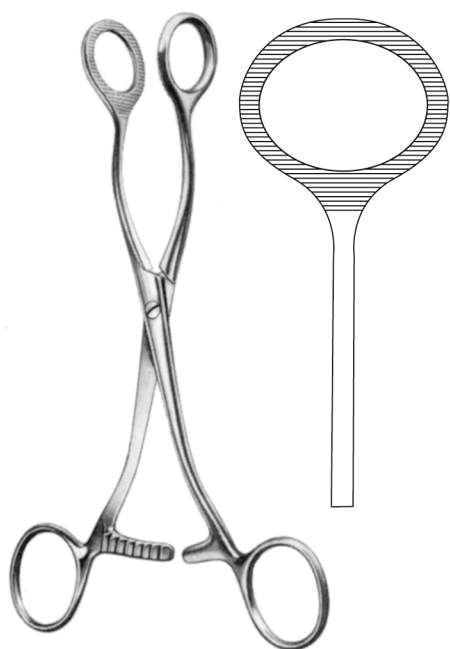

COLLIN
14.0658.16 16.5cm

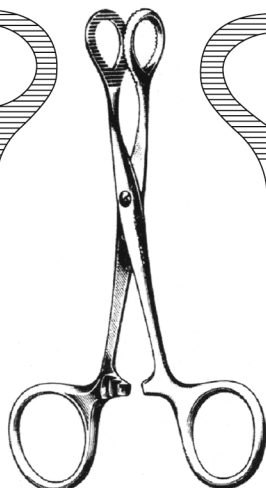
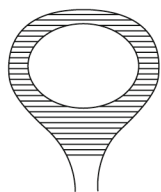
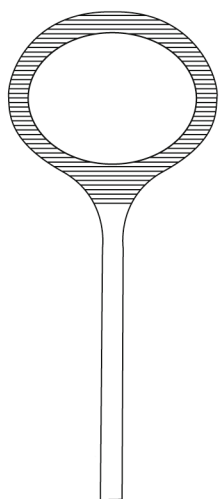

PEAN
14.0660.12 12.0cm 14.0662.12

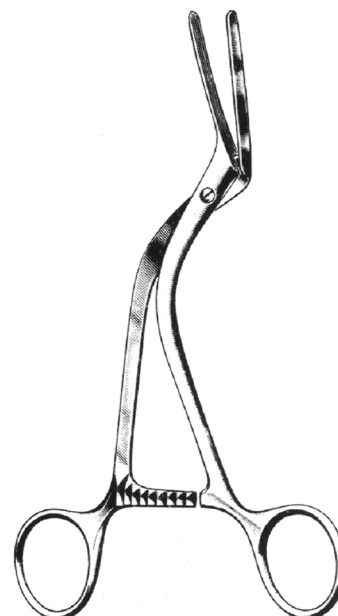
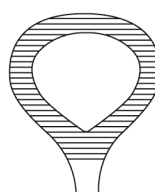

HOPFNER
14.0666.16 16.0cm

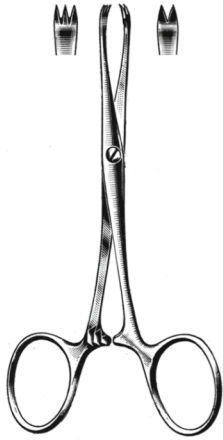

CHAPUT
14.0670.13 13.0cm

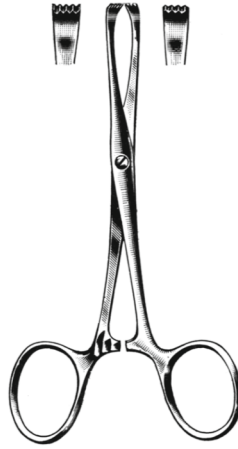

TUFFIER
14.0674.13 13.0cm

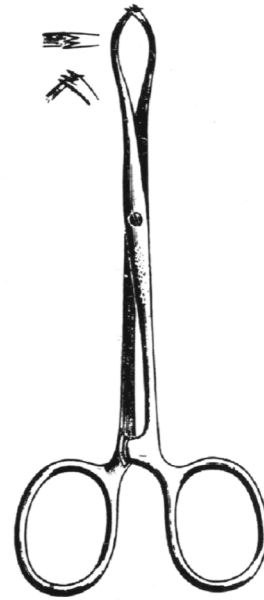

PORRIER
14.0678.12 12.5cm
14.0678.18 18.0cm

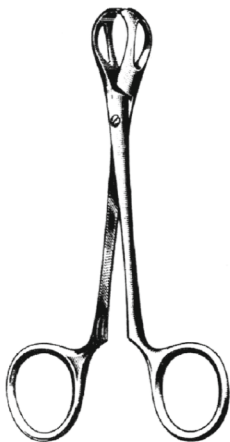

LANE
14.0680.12 12.5cm
14.0680.15 15.0cm
14.0680.19 19.5cm



LANE
14.0682.12 12.5cm
14.0682.15 15.0cm
14.0682.20 20.0cm



ATRAUMA



14.0686.25 25.0cm



14.0688.26 26.0cm

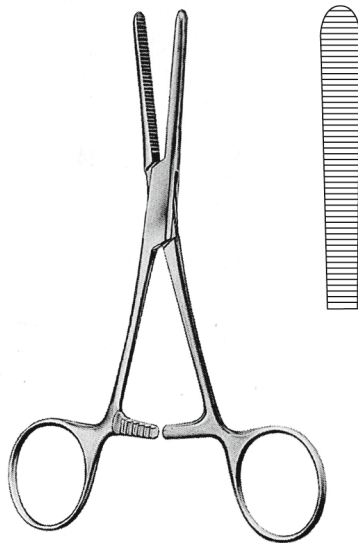

14.0690.14 14.5cm

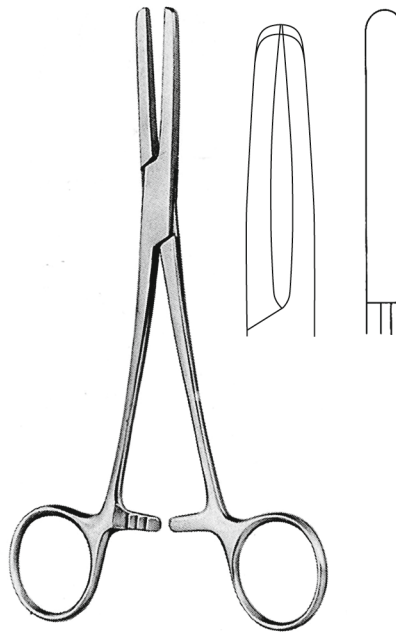

14.0692.16 16.5cm
14.0692.18 18.0cm
14.0692.20 20.0cm

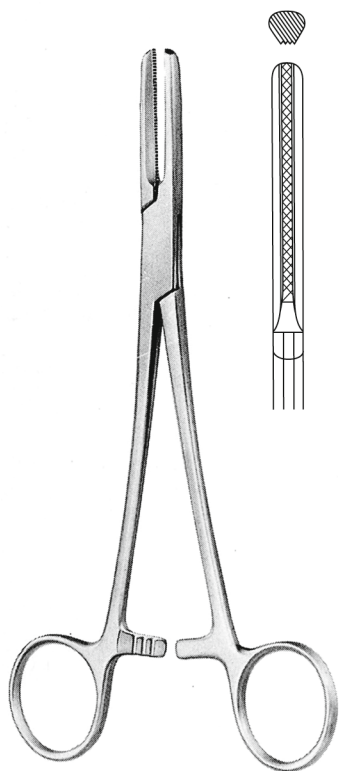

STANDARD
14.0700.15 15.0cm
14.0700.18 18.0cm
14.0700.20 20.0cm

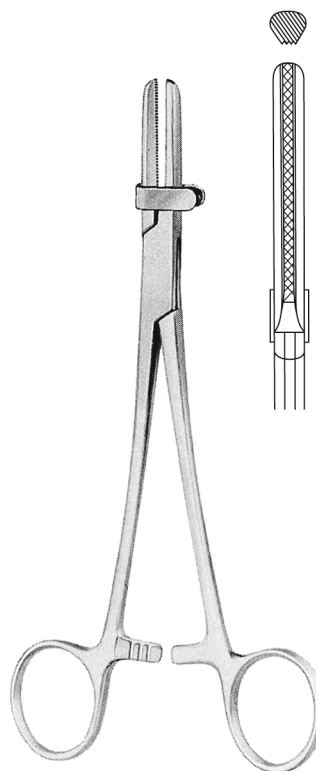

14.0702.15 15.0cm
14.0702.16 16.5cm
14.0702.18 18.0cm
14.0702.20 20.0cm

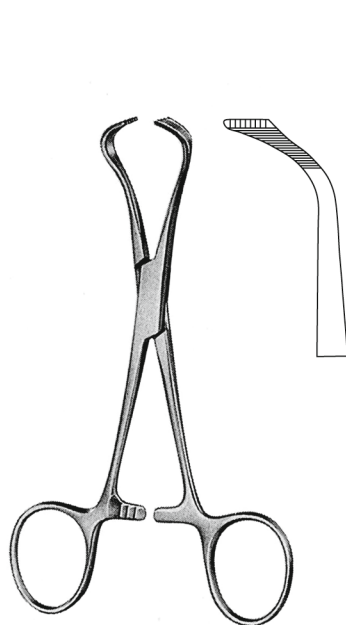

LORNA
14.0710.10 10.0cm
14.0710.13 13.0cm

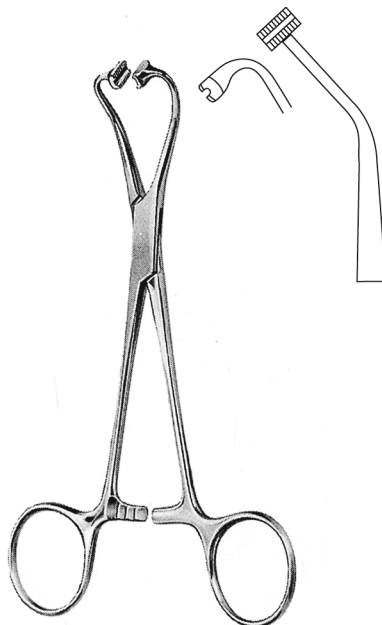

PEERS-BERTRAM
14.0714.14 14.5cm

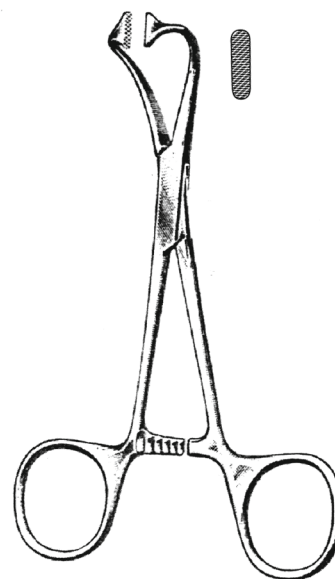

14.0718.10 10.0cm
14.0718.13 13.0cm

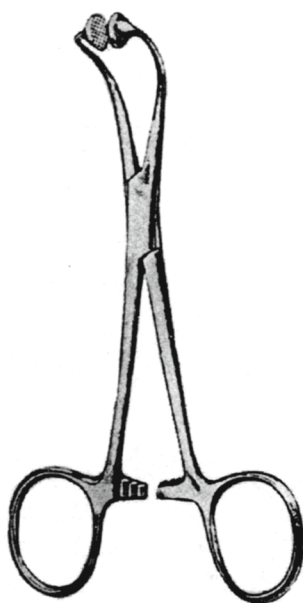

HOFF (HOFER)
14.0720.10 10.0cm
14.0720.14 14.5cm

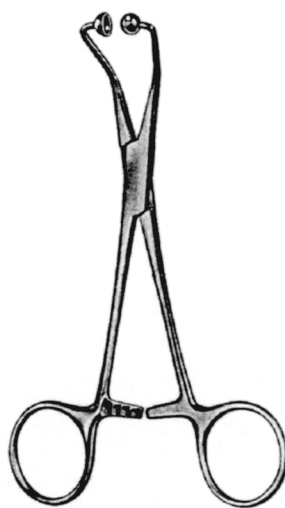

BALL AND SOCKET
14.0722.13 13.0cm

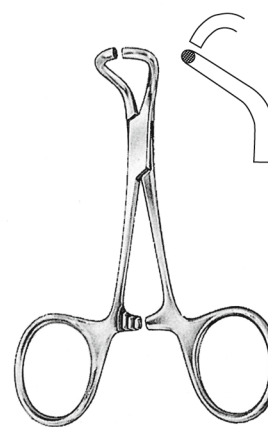

TONOKU
14.0726.10 10.0cm
14.0726.13 13.0cm



SCHAEDEL
14.0730.09 9.0cm



ENGLISH MODEL
14.0732.09 9.0cm



JONES
14.0734.05 5.0cm
14.0734.09 9.0cm

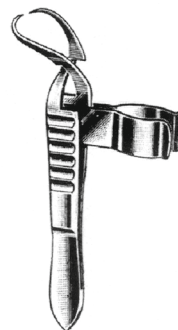

JONES
14.0736.09 9.0cm

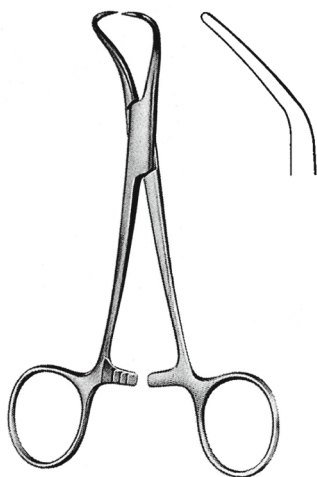

BACKHAUS
14.0740.08 08.0cm
14.0740.09 09.0cm
14.0740.11 11.0cm
14.0740.13 13.0cm
14.0740.14 14.0cm
14.0740.15 15.0cm



DELICATE
14.0742.11 11.0cm
14.0742.13 13.0cm

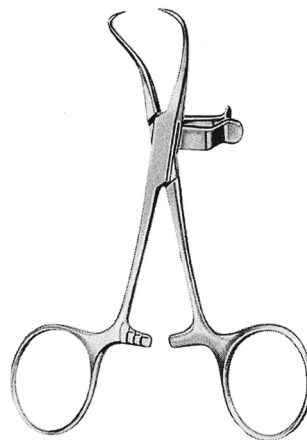

14.0746.11 11.0cm

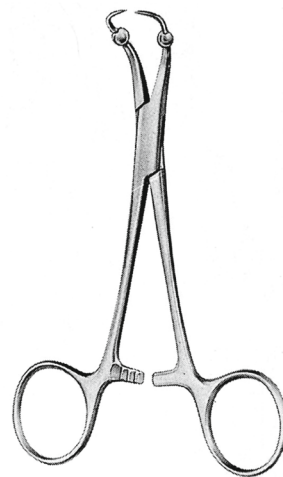

ROEDER
14.0750.13 13.0cm
14.0750.15 15.0cm



ROBIN
14.0754.13 13.5cm



ROBIN
14.0756.13 13.5cm



BERNHARD
14.0758.16 16.5cm

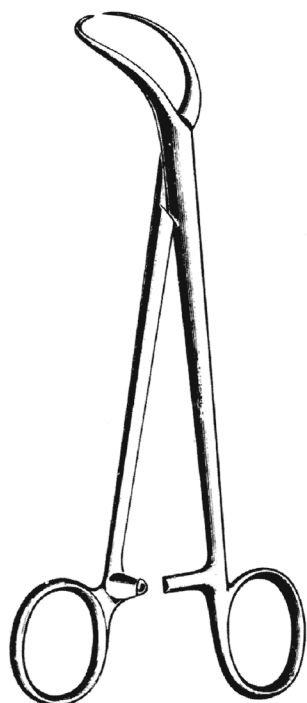

MAYO
14.0760.14 14.0cm

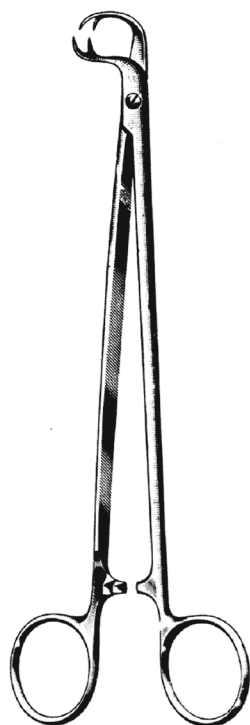

MOYNIHAN
14.0762.19 19.0cm

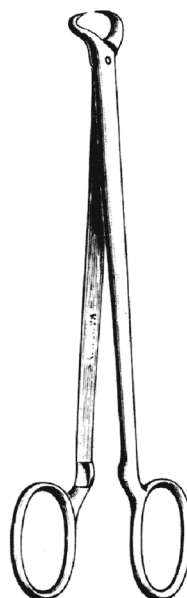

MOYNIHAN
14.0764.18 18.0cm



DOYEN
14.0766.18 18.0cm