

09 TC

Страницы раздела
019-026

НОЖНИЦЫ СУПЕРОСТРЫЕ - TC TC SUPER CUT SCISSORS

Перейти в **СОДЕРЖАНИЕ**



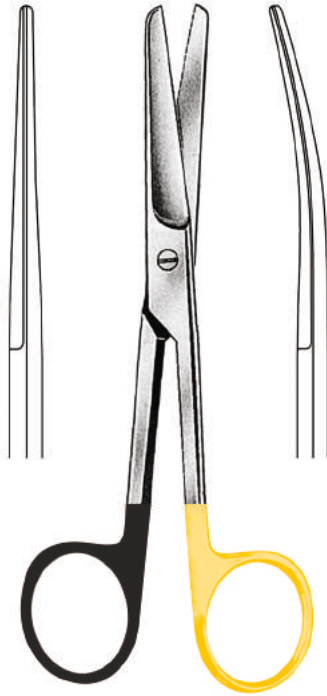

STANDARD		
10.5cm	09.5010.10	09.5011.10
11.5cm	09.5010.11	09.5011.11
13.0cm	09.5010.13	09.5011.13
14.5cm	09.5010.14	09.5011.14
15.5cm	09.5010.15	09.5011.15
16.5cm	09.5010.16	09.5011.16
18.5cm	09.5010.18	09.5011.18
20.0cm	09.5010.20	09.5011.20

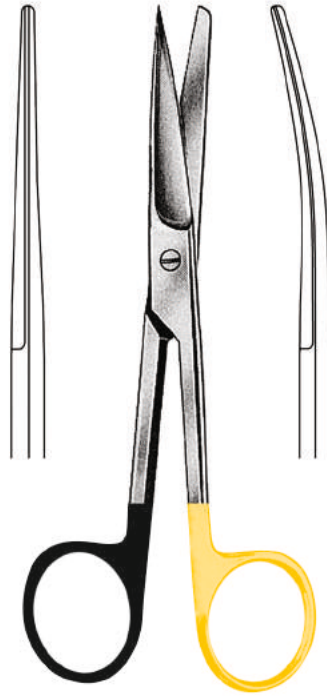

STANDARD		
09.5012.10	09.5013.10	
09.5012.11	09.5013.11	
09.5012.13	09.5013.13	
09.5012.14	09.5013.14	
09.5012.15	09.5013.15	
09.5012.16	09.5013.16	
09.5012.18	09.5013.18	
09.5012.20	09.5013.20	

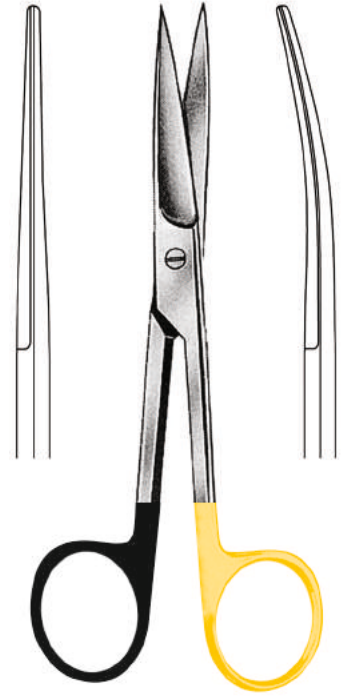

STANDARD		
09.5014.10	09.5015.10	
09.5014.11	09.5015.11	
09.5014.13	09.5015.13	
09.5014.14	09.5015.14	
09.5014.15	09.5015.15	
09.5014.16	09.5015.16	
09.5014.18	09.5015.18	
09.5014.20	09.5015.20	

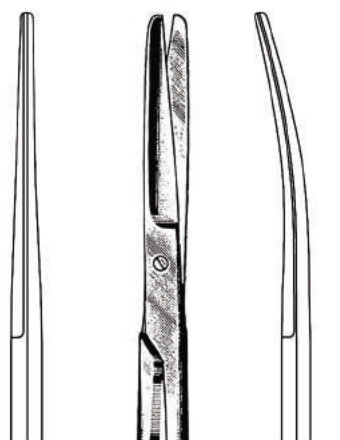

DEAVER

09.5034.14 14.0cm 09.5035.14

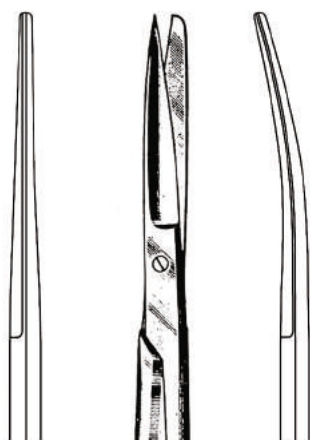

DEAVER

09.5036.14 14.0cm 09.5037.14

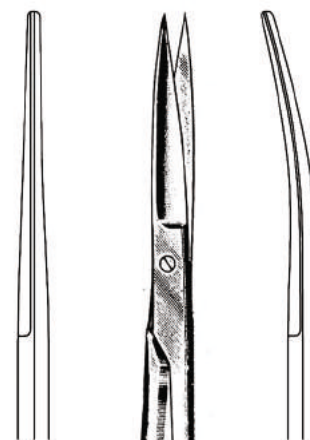

DEAVER

09.5038.14 14.0cm 09.5039.14

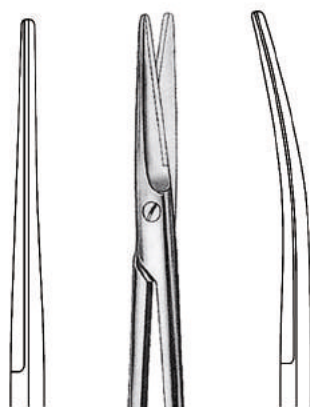

MAYO

09.5052.14 14.0cm 09.5053.14
09.5052.15 15.0cm 09.5053.15
09.5052.16 16.0cm 09.5053.16
09.5052.17 17.0cm 09.5053.17
09.5052.18 18.0cm 09.5053.18
09.5052.19 19.0cm 09.5053.19
09.5052.23 23.0cm 09.5053.23

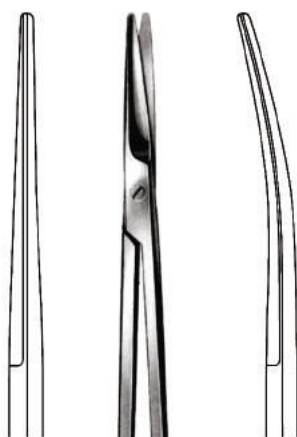

MAYO-HARRINGTON

09.5058.22 22.5cm 09.5059.22
09.5058.28 28.0cm 09.5059.28
09.5058.30 30.0cm 09.5059.30

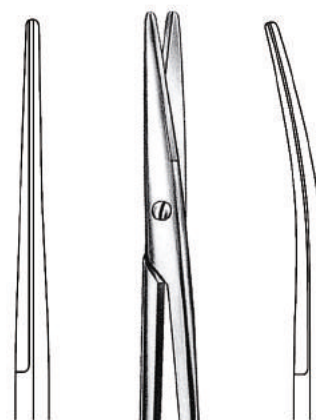

MAYO-STILLE

09.5064.15 15.0cm 09.5065.15
09.5064.16 16.0cm 09.5065.16
09.5064.19 19.0cm 09.5065.19
09.5064.21 21.0cm 09.5065.21

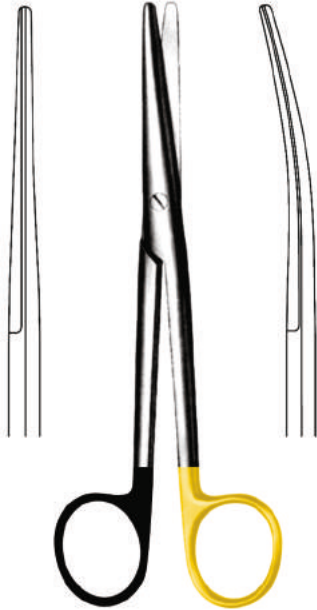

MAYO-STILLE

09.5068.15 15.0cm 09.5069.15
09.5068.17 17.0cm 09.5069.17
09.5068.21 21.0cm 09.5069.21

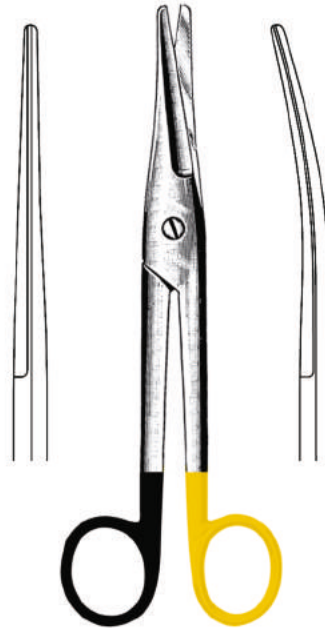

MAYO-NOBLE

09.5072.17 17.0cm 09.5073.17



IRIS

09.5142.09 9.0cm 09.5143.09
09.5142.10 10.5cm 09.5143.10

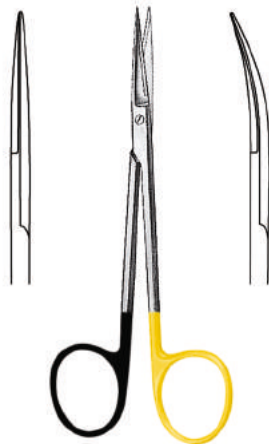

IRIS

09.5144.11 11.5cm 09.5145.11



IRIS

09.5149.11 11.0cm



STRABISMUS

09.5160.11 11.5cm 09.5161.11



09.5174.12 12.0cm
09.5174.15 15.0cm



REYNOLDS
09.5184.15 15.0cm 09.5185.15
09.5184.18 18.0cm 09.5185.18



SANVENERO
09.5190.14 14.0cm 09.5191.14



JOSEPH
09.5196.14 14.0cm 09.5197.14



LEXER-BABY
09.5300.10 10.0cm 09.5301.10

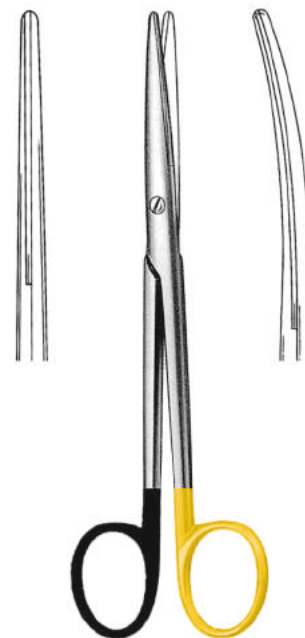

LEXER
09.5306.16 16.0cm 09.5307.16
09.5306.21 21.0cm 09.5307.21



MAYO-LEXER
09.5308.16 16.0cm 09.5309.16

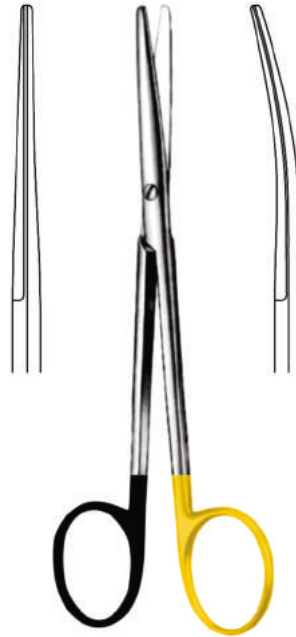

LEXER-FINO
09.5310.16 16.0cm 09.5311.16



FOMON
09.5320.13 13.5cm

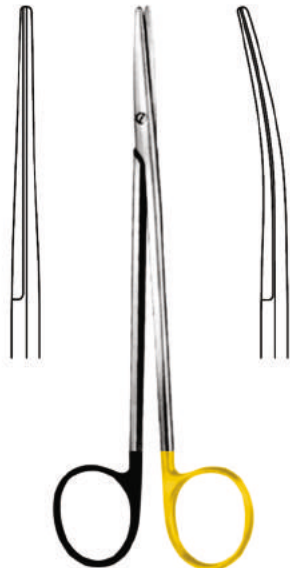

METZENBAUM
09.5336.14 14.0cm 09.5337.14
09.5336.15 15.0cm 09.5337.15



METZENBAUM-FINO
09.5350.14 14.5cm 09.5351.14
09.5350.18 18.0cm 09.5351.18
09.5350.20 20.0cm 09.5351.20
09.5350.23 23.0cm 09.5351.23

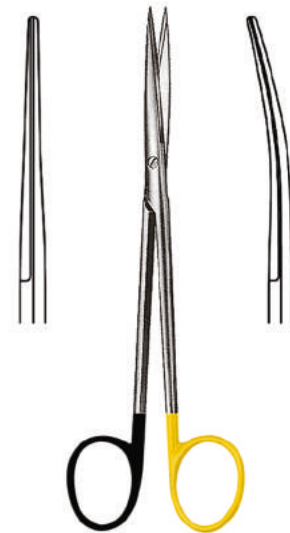

METZENBAUM-FINO
09.5352.14 14.5cm 09.5353.14
09.5352.18 18.0cm 09.5353.18
09.5352.20 20.0cm 09.5353.20
09.5352.23 23.0cm 09.5353.23



METZENBAUM-FINO

09.5360.18 18.0cm 09.5361.18
09.5360.20 20.0cm 09.5361.20
09.5360.23 23.0cm 09.5361.23



METZENBAUM-FINO

09.5362.18 18.0cm 09.5363.18
09.5362.20 20.0cm 09.5363.20
09.5362.23 23.0cm 09.5363.23

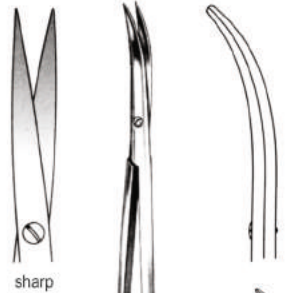

METZENBAUM-FINO

09.5370.18 18.0cm
09.5370.20 20.0cm
09.5370.23 23.0cm

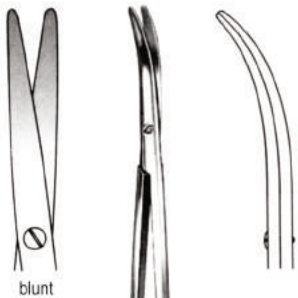

METZENBAUM-FINO

09.5374.18 18.0cm
09.5374.20 20.0cm
09.5374.23 23.0cm

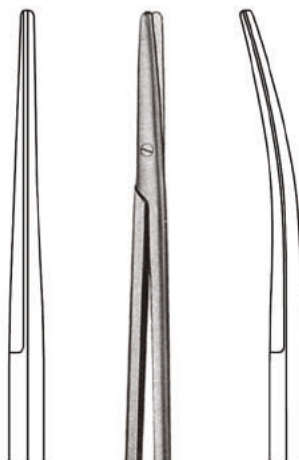

METZENBAUM - NELSON

09.5380.18 18.0cm 09.5381.18
09.5380.20 20.0cm 09.5381.20
09.5380.23 23.0cm 09.5381.23
09.5380.25 25.0cm 09.5381.25
09.5380.28 28.0cm 09.5381.28
09.5380.30 30.0cm 09.5381.30

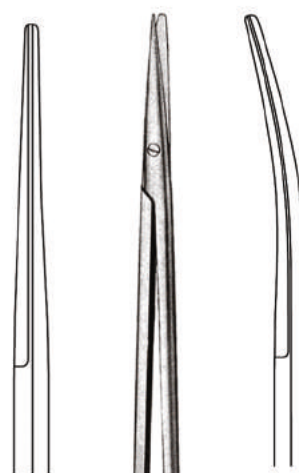

METZENBAUM - NELSON

09.5382.18 18.0cm 09.5383.18
09.5382.20 20.0cm 09.5383.20
09.5382.23 23.0cm 09.5383.23
09.5382.25 25.0cm 09.5383.25
09.5382.28 28.0cm 09.5383.28
09.5382.30 30.0cm 09.5383.30

09 TC

Ножницы препаровальные Ножницы сосудистые

Dissecting Scissors, Vascular Scissors

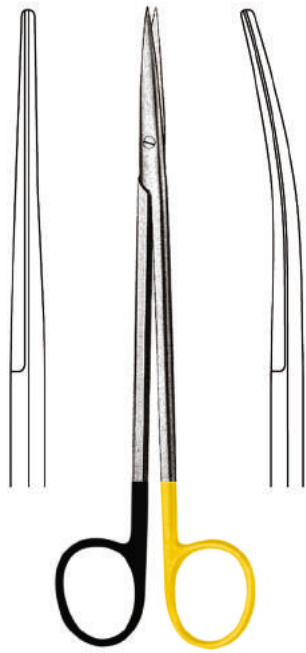

METZENBAUM - NELSON

09.5384.18 18.0cm 09.5385.18
09.5384.20 20.0cm 09.5385.20
09.5384.23 23.0cm 09.5385.23
09.5384.25 25.0cm 09.5385.25
09.5384.28 28.0cm 09.5385.28
09.5384.30 30.0cm 09.5385.30

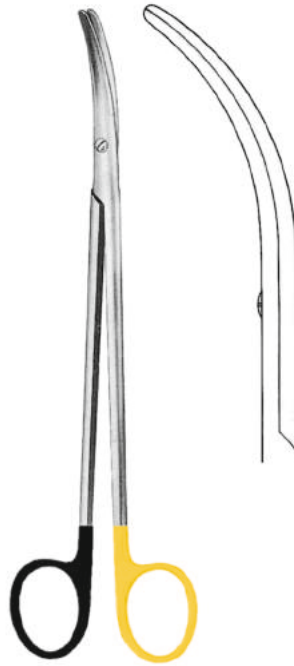

METZENBAUM-THOREK

09.5388.20 20.0cm
09.5388.23 23.0cm
09.5388.28 28.0cm



METZENBAUM-S

09.5392.20 20.0cm
09.5392.23 23.0cm
09.5392.25 25.0cm
09.5392.28 28.0cm

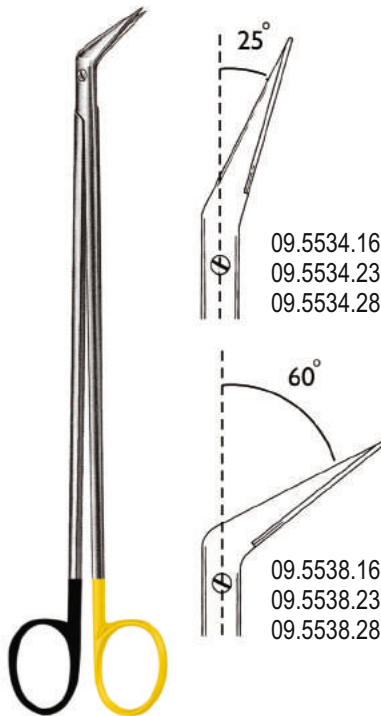

DE BAKEY

16.0cm, 23.0cm, 28.0cm

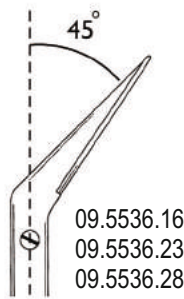

09.5536.16
09.5536.23
09.5536.28

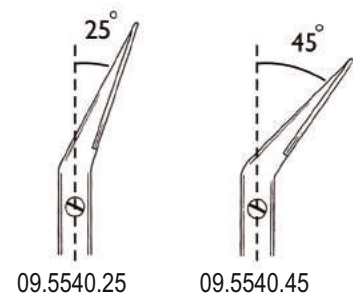

09.5540.25

09.5540.45

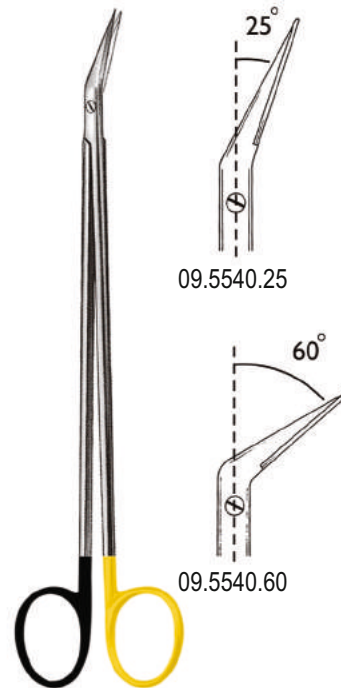

POTTS - SMITH

19.0cm

09.5540.60

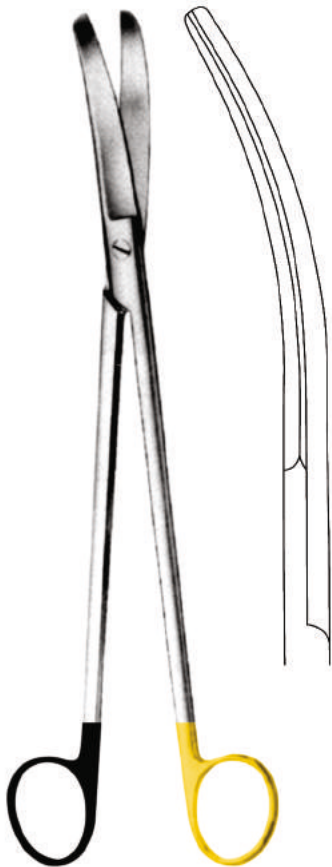

LLOYD-DAVIES (GOLIGHER'S)
09.5646.25 25.5cm

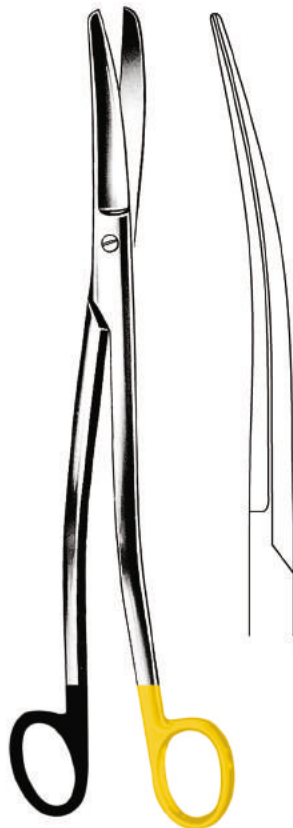

SIEBOLD
09.5650.24 24.0cm



WERTHEIM
09.5654.14 14.5cm
09.5654.19 19.5cm
09.5654.22 22.5cm

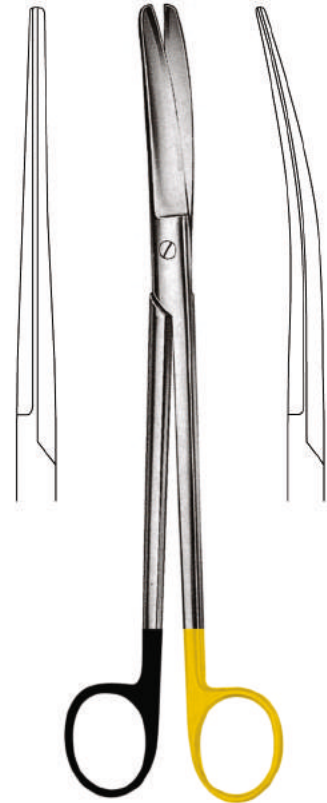

SIMS
09.5660.20 20.0cm 09.5661.20
09.5660.23 23.0cm 09.5661.23