

# 26

Страницы раздела  
001-020

## КОСТНАЯ ХИРУРГИЯ BONE SURGERY

Перейти в **СОДЕРЖАНИЕ**

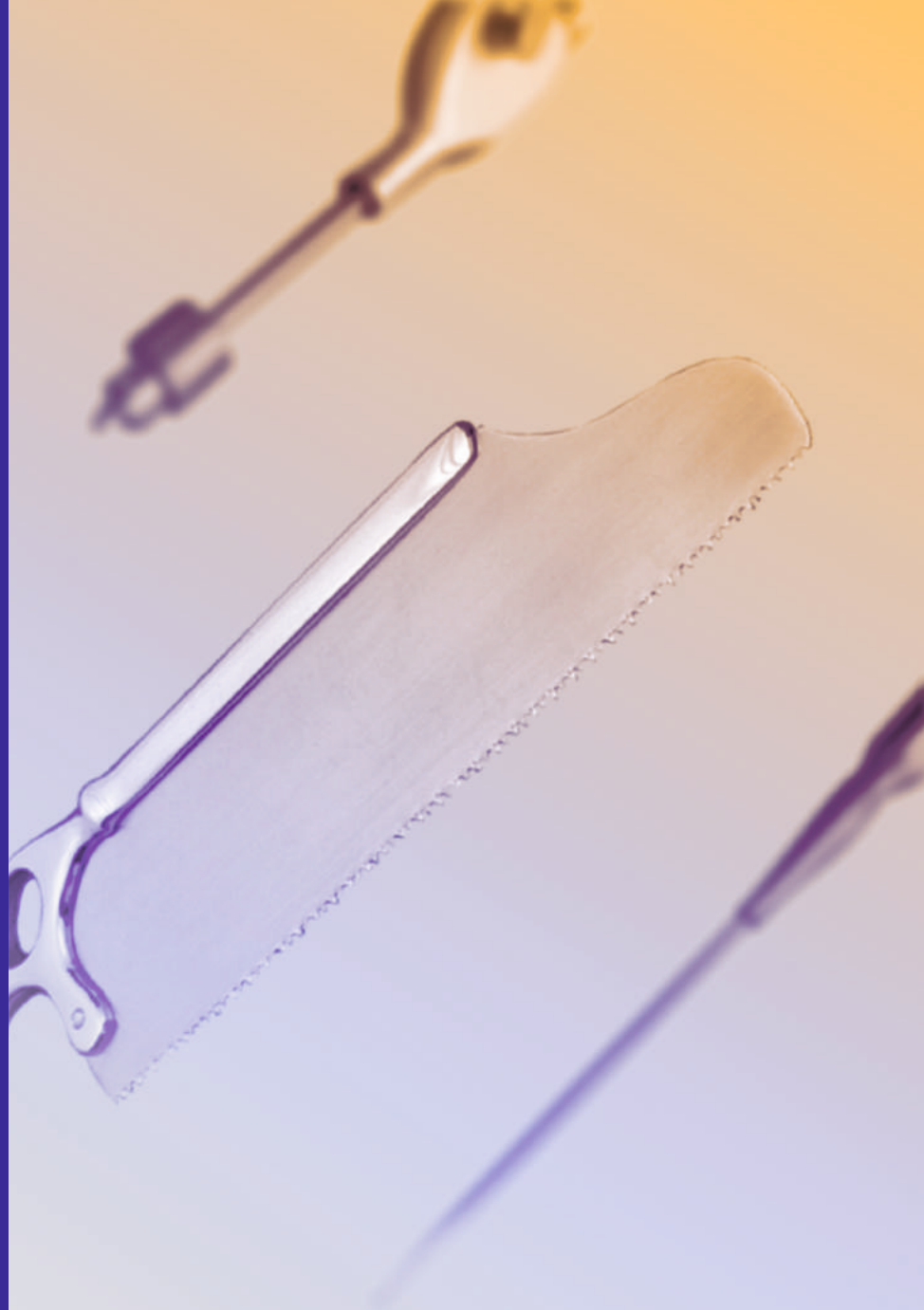



**CHARRIERE**  
26.0010.27 27.0cm  
26.0010.30 30.0cm  
26.0010.34 34.0cm



**SATTERLEE**  
26.0014.31 31.0cm



**CHARRIERE**  
26.0020.27 27.0cm  
26.0020.30 30.0cm



**SATTERLEE**  
26.0024.31  
31.0cm

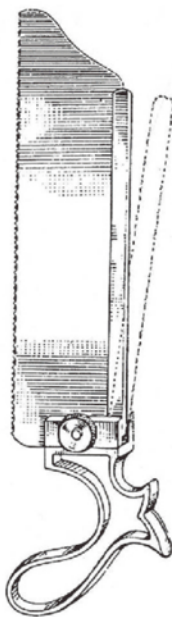

26.0030.23  
23.0cm

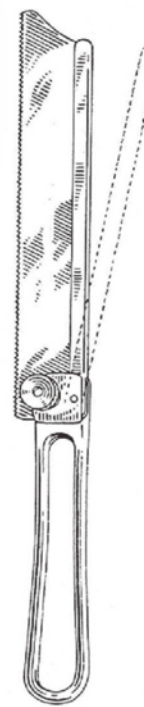

26.0034.19  
19.0cm



**SPARE SAW BLADE**

26.0040.12 12mm  
26.0040.15 15mm  
26.0040.18 18mm



**CHAARRIERE**  
26.0040.35 35.0cm



**SPARE SAW BLADE**

26.0044.03 3mm  
26.0044.05 5mm  
26.0044.07 7mm



**HELFERICH-BIER**  
26.0044.39 39.0cm



**LINDEMANN**  
26.0050.20 20.0cm



**LANGENBECK**  
26.0054.23 23.0cm

26.0060.06 6mm  
26.0060.08 8mm  
26.0060.12 12mm  
26.0060.15 15mm  
26.0060.18 18mm



**RUST**  
26.0060.39 39.0cm





**STILLE-SHERMAN**

24.0cm

26.0070.00 compl. set

26.0070.24 drill only



26.0072.25  
2.5mm Ø



26.0072.30  
3.0mm Ø



26.0072.35  
3.5mm Ø



**HUDSON**

26.0074.00 compl. set / 6  
(26.0074.27,01,  
02,03,07,09)

26.0074.27 handle only



26.0076.01  
9mm Ø



26.0076.02  
14mm Ø



26.0076.03  
16mm Ø



26.0076.04  
22mm Ø



**CUSHING**  
26.0076.05  
14mm Ø



26.0076.06  
2mm Ø



**MCKENZIE**  
26.0076.07  
13mm Ø



**ERRICO**  
26.0076.08  
16mm Ø



26.0076.09



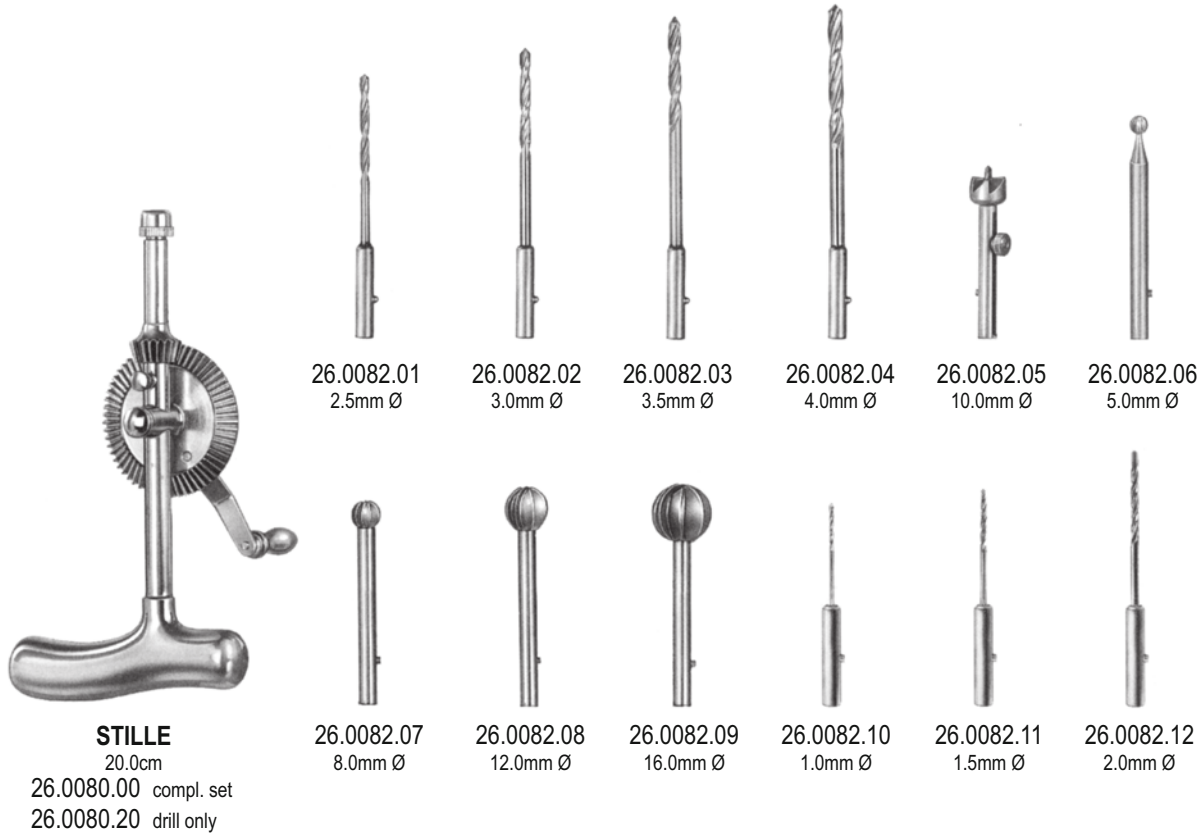

**STILLE**  
20.0cm  
26.0080.00 compl. set  
26.0080.20 drill only

26.0082.01 2.5mm Ø  
26.0082.02 3.0mm Ø  
26.0082.03 3.5mm Ø  
26.0082.04 4.0mm Ø  
26.0082.05 10.0mm Ø  
26.0082.06 5.0mm Ø  
26.0082.07 8.0mm Ø  
26.0082.08 12.0mm Ø  
26.0082.09 16.0mm Ø  
26.0082.10 1.0mm Ø  
26.0082.11 1.5mm Ø  
26.0082.12 2.0mm Ø



26.0084.00 compl. set  
26.0084.01 drill only



26.0084.09 9.0cm 3.2mm Ø  
26.0084.07 7.0cm 3.2mm Ø  
26.0084.08 Set of drills



**JACOBS**  
26.0090.00 6.35mm



26.0092.00 set

26.0094.00 set



**BUNNELL**  
26.0100.00



**RALK**  
26.0104.00

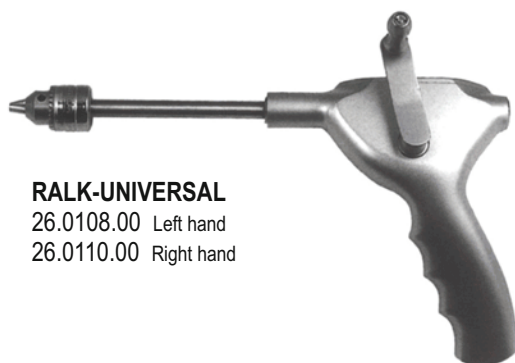

**RALK-UNIVERSAL**  
26.0108.00 Left hand  
26.0110.00 Right hand

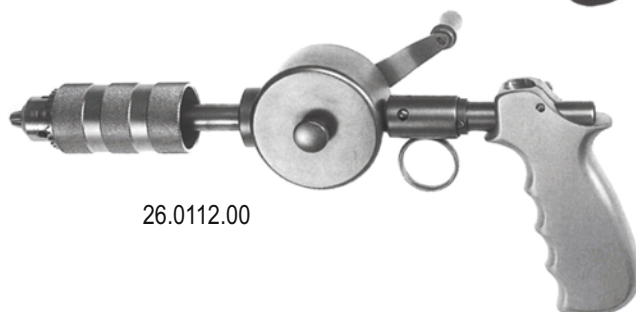

26.0112.00

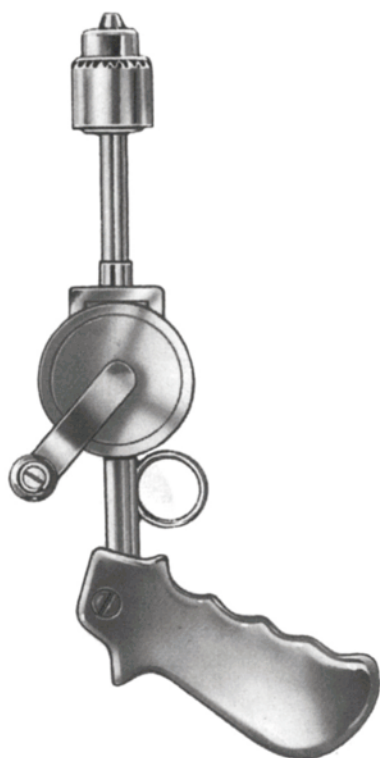

26.0116.00



26.0120.00



26.0122.00



26.0124.01

26.0124.00 complete set



26.0128.01

26.0128.02



26.0128.03

**KIRSCHNER**  
26.0128.00 complete set

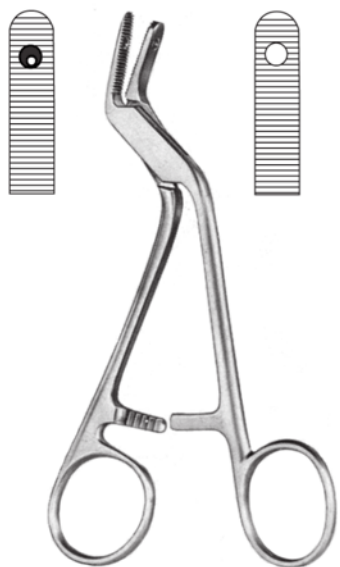

**ADSON**  
26.0130.15  
15.0cm



**ADSON**  
26.0134.18  
18.0cm

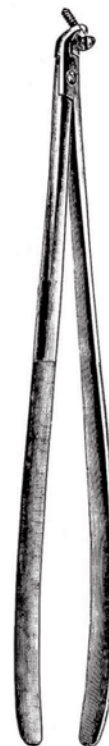

**LANE**  
26.0140.22  
22.0cm

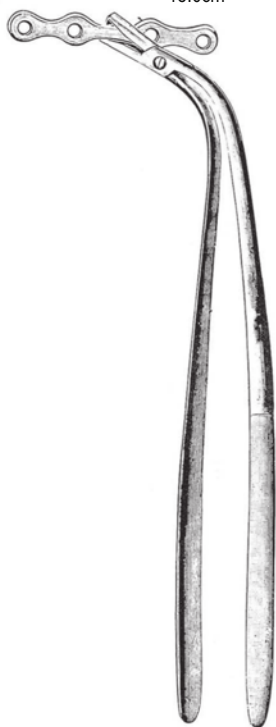

**LANE**  
26.0144.22  
22.0cm



**LANE**  
26.0150.18  
18.0cm



26.0154.25  
25.5cm



26.0160.25 25.0cm



**PHILLIPS**  
26.0164.25 25.0cm



**LANE**  
26.0170.17 17.0cm  
26.0170.25 25.0cm

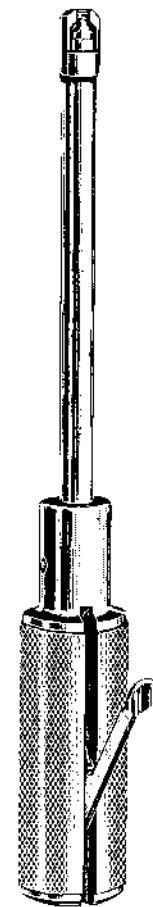

**WILLIAMS**  
26.0174.24 24.0cm — flat  
26.0176.24 24.0cm + cross slot



26.0180.25 2.5mm  
26.0180.35 3.5mm  
26.0180.45 4.5mm  
25.0cm



**PHILLIPS**  
26.0184.25 25.0cm



26.0190.25 25.0cm



**LANE**  
26.0194.17 17.0cm  
26.0194.25 25.0cm



1/2

26.0200.14 14.5cm



1/1

26.0200.13

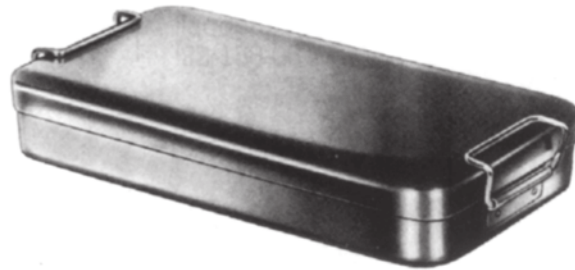

26.0200.00 Screw driver set, complete in case  
26.0200.01 Sterilizing case only



1/1

26.0200.02



1/1

26.0200.03



1/1

26.0200.04



1/1

26.0200.05



1/1

26.0200.06  
26.0200.07





26.0210.24  
2.4mm



26.0210.32  
3.2mm



26.0210.48  
4.8mm



26.0210.64  
6.4mm



26.0220.14 14.0cm



26.0222.14 14.0cm



**PERTHES**  
26.0224.21 21.0mm



26.0226.24 2.4mm  
26.0226.32 3.2mm  
26.0226.48 4.8mm  
26.0226.64 6.4mm



26.0230.16 16.5cm

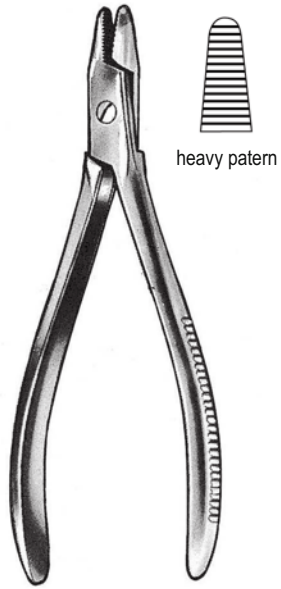

26.0232.16 16.0cm



26.0236.15 15.0cm



26.0240.17 17.0cm



26.0242.18 18.0cm

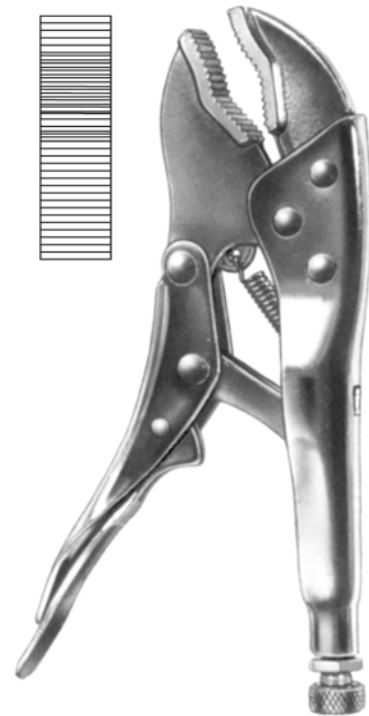

26.0244.18 18.0cm



17.0cm



26.0250.01



26.0250.02



18.0cm



26.0254.01



26.0254.02



26.0254.03



parallel action



14.0cm



26.0258.01



26.0258.02



26.0262.16 16.0cm

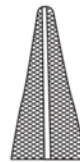

26.0266.19 19.5cm

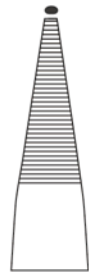



**PARHAM**

26.0270.18 18.0cm  
26.0270.20 20.0cm  
26.0270.25 25.0cm  
26.0270.30 30.0cm



**PARHAM**

26.0274.22 22.0cm

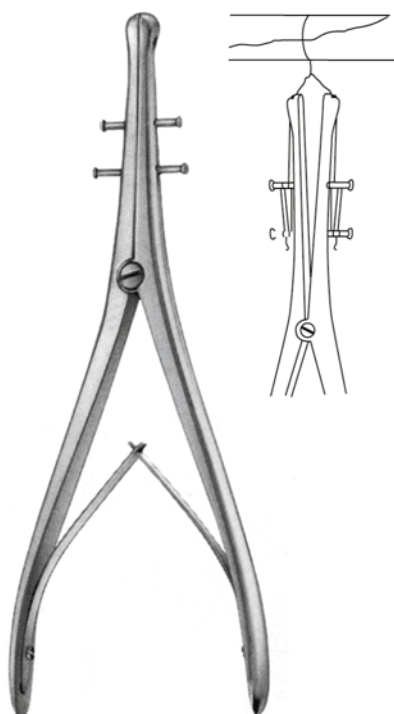

**DEMEL**

26.0280.28 28.0cm



**LOUTE**

26.0284.21 21.0cm



**LLOYD**

26.0288.00



	soft	hard
0.2mm Ø	26.0290.02	
0.3mm Ø	26.0290.03	26.0292.03
0.4mm Ø	26.0290.04	26.0292.04
0.5mm Ø	26.0290.05	
0.6mm Ø	26.0290.06	26.0292.06
0.7mm Ø	26.0290.07	
0.8mm Ø	26.0290.08	26.0292.08
0.9mm Ø	26.0290.09	
1.0mm Ø	26.0290.10	26.0292.10
1.2mm Ø	26.0290.12	
1.5mm Ø	26.0290.15	

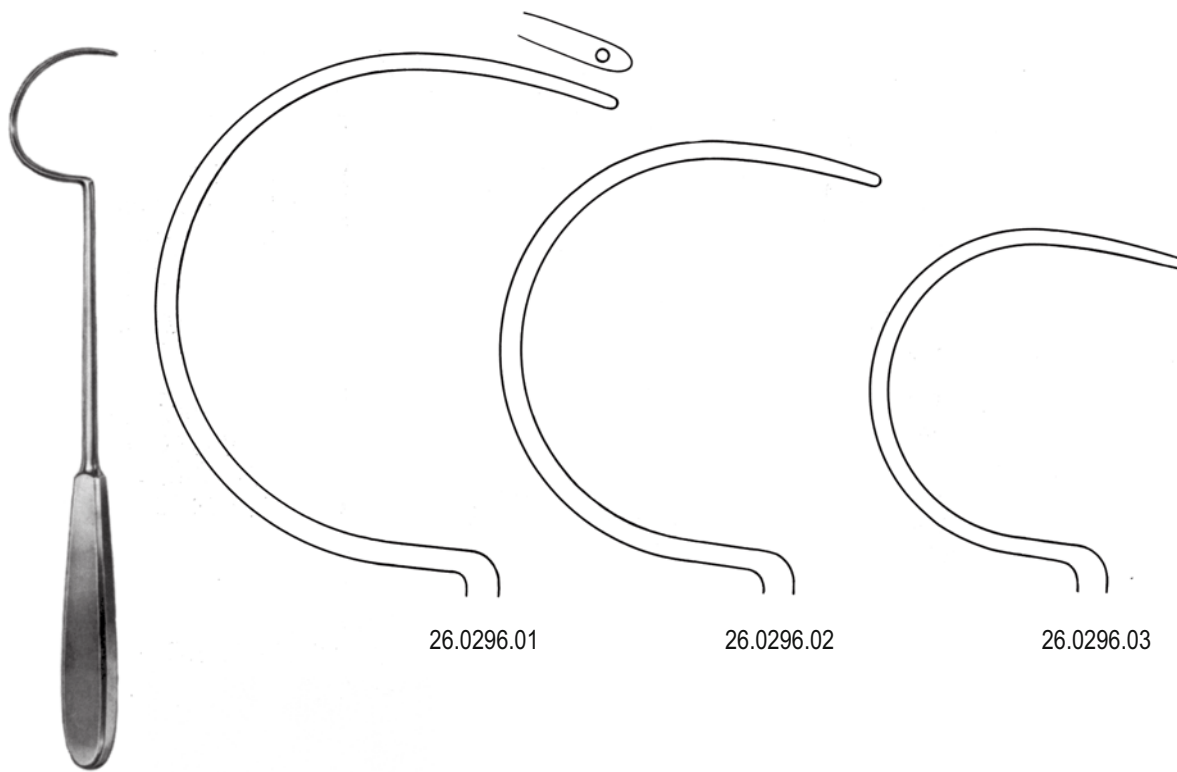

DEMEL



**KUENTSCHER**  
26.0304.21 21.0cm



**KUENTSCHER**  
26.0306.21 21.0cm



**KUENTSCHER**  
26.0310.00 63.0cm  
complete set



26.0310.01 26.0310.02



26.0310.03 26.0310.04



26.0314.29 29.0cm  
26.0314.37 37.0cm  
26.0314.42 42.0cm  
26.0314.49 49.0cm

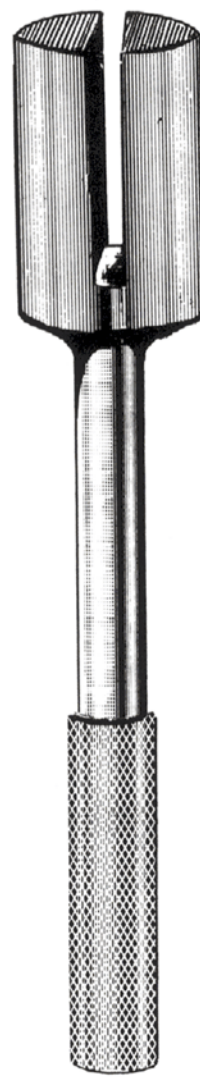

26.0320.00





	L=35cm	L=46cm	L=60cm
2.5mm Ø	26.0330.25	26.0332.25	
3.0mm Ø	26.0330.30	26.0332.30	
3.5mm Ø	26.0330.35	26.0332.35	26.0334.35
4.0mm Ø	26.0330.40	26.0332.40	26.0334.40
5.0mm Ø	26.0330.50	26.0332.50	26.0334.50



**KUENTSCHER**  
26.0340.26 26.0cm



**KUENTSCHER**  
26.0344.35 35.0cm



**STEINMANN**  
4mm Ø (Trocar tip)  
26.0360.14 140mm  
26.0360.16 160mm  
26.0360.18 180mm  
26.0360.20 200mm



**SCHANZ**  
4mm Ø (Flat tip)  
26.0364.06 60mm  
26.0364.08 80mm  
26.0364.10 100mm



**SCHANZ**  
6mm Ø (Flat tip)  
26.0366.10 100mm  
26.0366.13 130mm  
26.0366.16 160mm  
26.0366.19 190mm



**SCHANZ**  
5mm Ø (Trocar tip)  
26.0368.10 100mm  
26.0368.12 125mm  
26.0368.15 150mm  
26.0368.17 170mm  
26.0368.20 200mm  
26.0368.25 250mm



**KIRSCHNER**  
trocar point  
flat end



mm ø	60 mm	120mm	140mm	160mm	310mm
0.6	26.0380.06				
0.8	26.0380.08				
1.0	26.0380.10	26.0382.10	26.0384.10	26.0386.10	26.0388.10
1.2	26.0380.12	26.0382.12	26.0384.12	26.0386.12	26.0388.12
1.4	26.0380.14	26.0382.14	26.0384.14	26.0386.14	26.0388.14
1.5	26.0380.15	26.0382.15	26.0384.15	26.0386.15	26.0388.15
1.6	26.0380.16	26.0382.16	26.0384.16	26.0386.16	26.0388.16
1.8	26.0380.18	26.0382.18	26.0384.18	26.0386.18	26.0388.18
2.0	26.0380.20	26.0382.20	26.0384.20	26.0386.20	26.0388.20
2.2	26.0380.22	26.0382.22	26.0384.22	26.0386.22	26.0388.22
2.5	26.0380.25	26.0382.25	26.0384.25	26.0386.25	26.0388.25

**KIRSCHNER**  
trocar point  
round end



mm ø	60 mm	120mm	140mm	160mm	310mm
1.0	26.0390.10	26.0392.10	26.0394.10	26.0396.10	26.0398.10
1.2	26.0390.12	26.0392.12	26.0394.12	26.0396.12	26.0398.12
1.4	26.0390.14	26.0392.14	26.0394.14	26.0396.14	26.0398.14
1.5	26.0390.15	26.0392.15	26.0394.15	26.0396.15	26.0398.15
1.6	26.0390.16	26.0392.16	26.0394.16	26.0396.16	26.0398.16
1.8	26.0390.18	26.0392.18	26.0394.18	26.0396.18	26.0398.18
2.0	26.0390.20	26.0392.20	26.0394.20	26.0396.20	26.0398.20
2.2	26.0390.22	26.0392.22	26.0394.22	26.0396.22	26.0398.22
2.5	26.0390.25	26.0392.25	26.0394.25	26.0396.25	26.0398.25

**KIRSCHNER**  
lancet point  
flat end



mm ø	100 mm
1.0	26.0400.10
1.2	26.0400.12
1.5	26.0400.15
1.6	26.0400.16
1.8	26.0400.18
2.0	26.0400.20
2.2	26.0400.22
2.5	26.0400.25

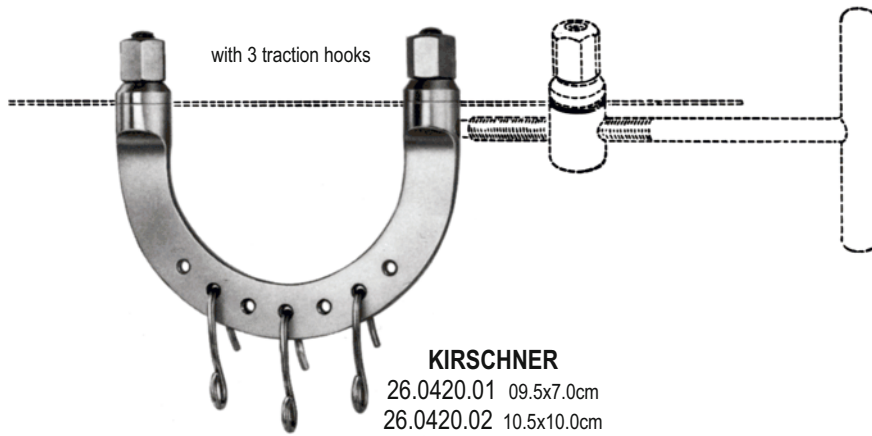

**KIRSCHNER**

- 26.0420.01 09.5x7.0cm
- 26.0420.02 10.5x10.0cm
- 26.0420.03 12.0x12.0cm
- 26.0420.04 15.5x15.5cm
- 26.0420.05 20.0x15.5cm



**KIRSCHNER**

- 26.0424.01 6.0x6.0cm



- 26.0430.18 18.0x10.0cm
- 26.0430.27 27.0x27.0cm

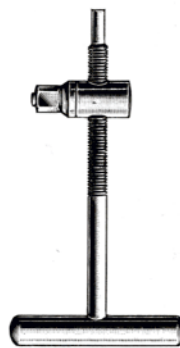

- 26.0434.18



- 26.0440.19 19.0cm



- 26.0444.03
- 26.0444.06

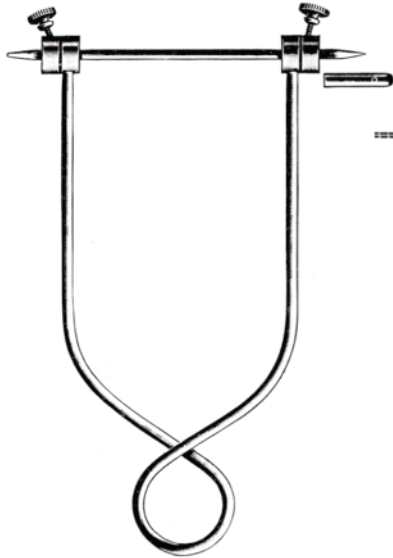

**BÖHLER**

26.0450.15 21.0x15.0cm  
26.0450.16 16.0x 9.0cm  
26.0450.21 21.0x11.0cm



**KIRSCHNER**

26.0454.01 13.5cm, infant  
26.0454.02 18.5cm, child  
26.0454.03 27.0cm, adult



**MARTIN-DIAMANT**

26.0460.16  
16.0cm



26.0464.16  
16.0cm



26.0470.15  
15.0cm



26.0474.23  
23.0cm



26.0474.25  
25.0cm



26.0480.24  
24.0cm