

# 21 TC

Страницы раздела  
033-052

## ШОВНЫЙ ИНСТРУМЕНТ - TC TC-SUTURE

Перейти в **СОДЕРЖАНИЕ**

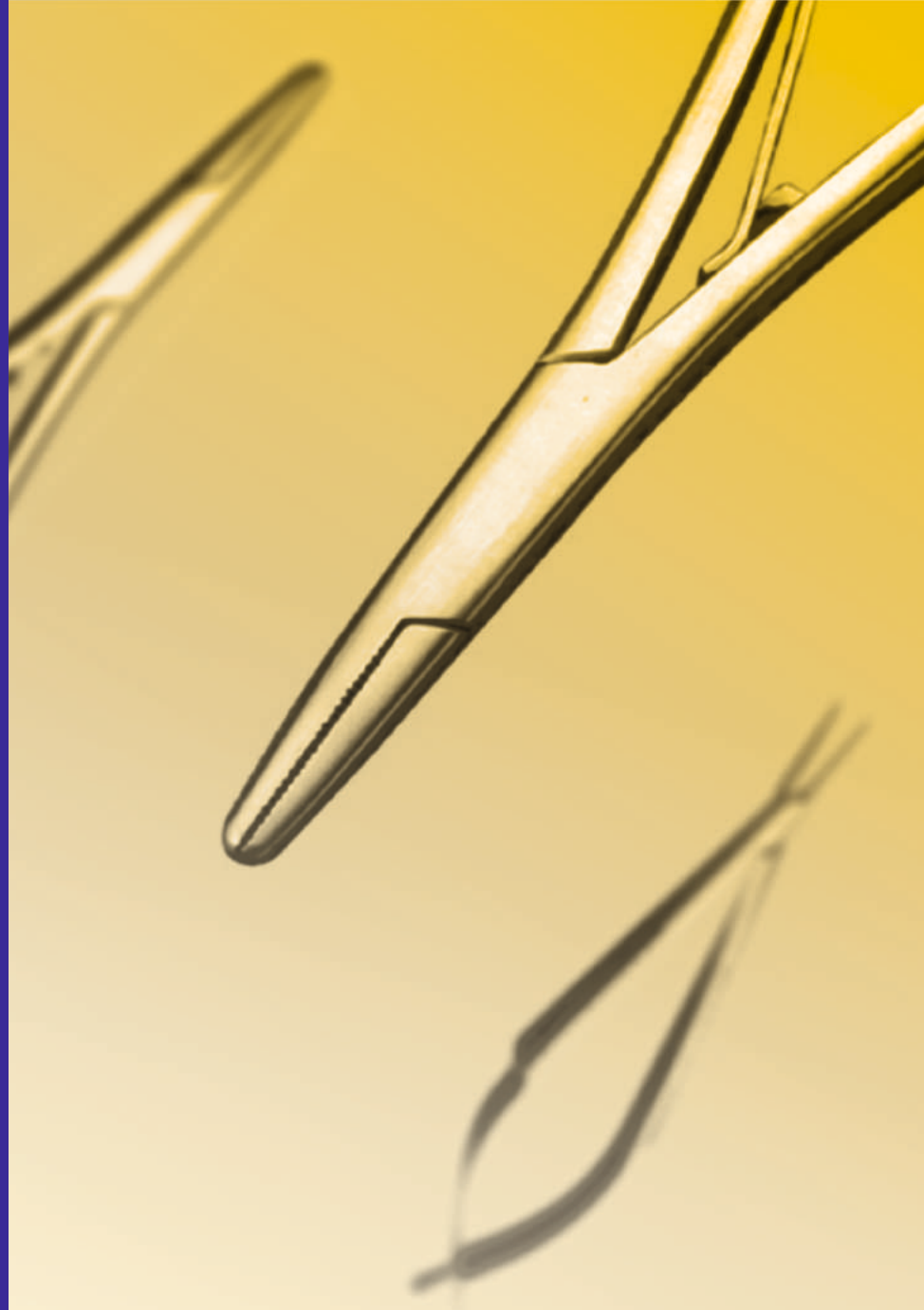



**DERF**  
21.5012.12 12.5cm

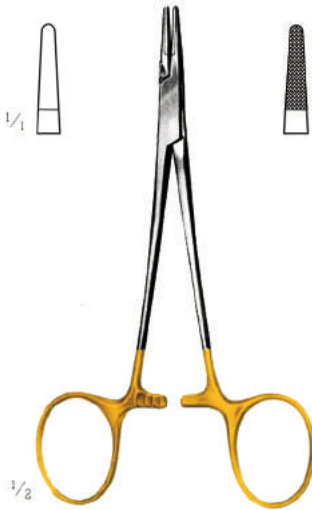

**WEBSTER**  
21.5024.13 13.0cm 21.5026.13  
smooth



**HALSEY**  
21.5030.13 13.0cm 21.5032.13  
smooth



**HEGAR-BAUMGARTNER**  
21.5040.12 12.5cm  
21.5040.14 14.0cm



**MAYO-HEGAR**  
21.5050.14 14.0cm  
21.5050.15 15.0cm  
21.5050.16 16.0cm  
21.5050.18 18.0cm  
21.5050.20 20.0cm  
21.5050.22 22.0cm  
21.5050.24 24.0cm  
21.5050.26 26.0cm  
21.5050.30 30.0cm

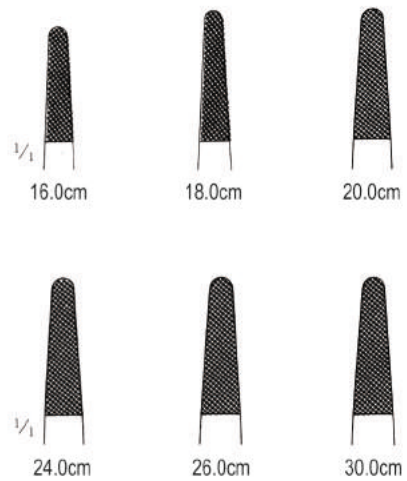

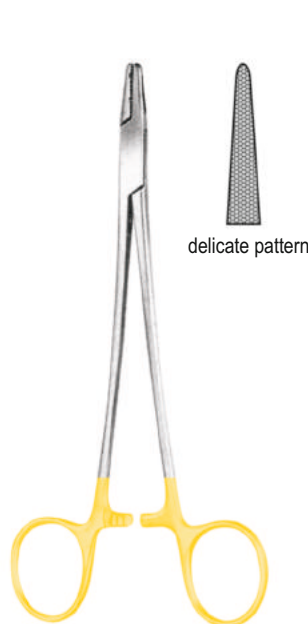

**MAYO-HEGAR**

21.5056.16 16.0cm  
21.5056.18 18.0cm  
21.5056.20 20.0cm



**NEW-ORLEANS**

21.5058.18 18.0cm



**CRILE-WOOD (NEWMAN)**

21.5062.15 15.0cm  
21.5062.18 18.0cm  
21.5062.20 20.0cm  
21.5062.23 23.0cm  
21.5062.26 26.0cm

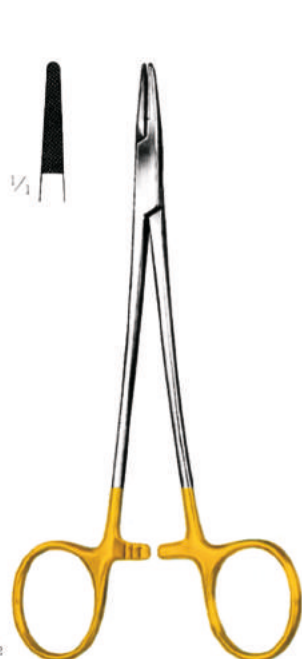

**CRILE-WOOD**

21.5066.13 13.0cm  
21.5066.15 15.0cm  
21.5066.18 18.0cm  
21.5062.20 20.0cm  
21.5062.23 23.0cm



**HEGAR**

21.5070.20 20.0cm

21.5070.24 24.0cm

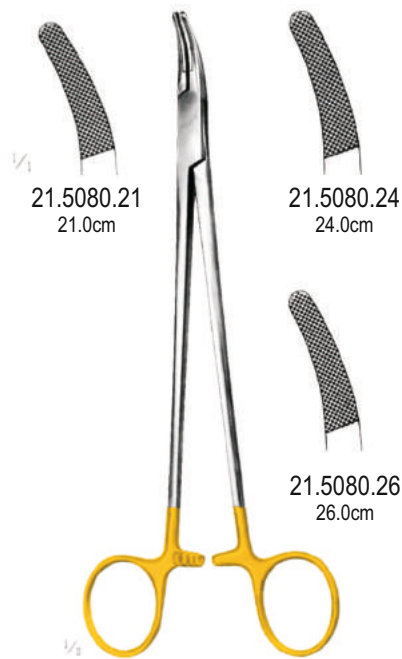

**HEANEY**

21.5080.21 21.0cm

21.5080.24 24.0cm

21.5080.26 26.0cm

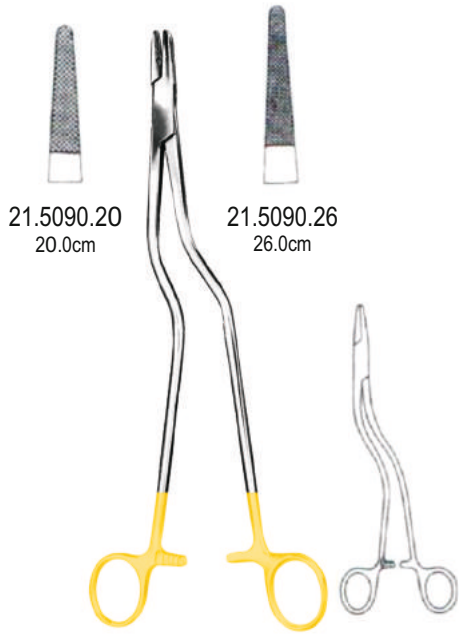

21.5090.20  
20.0cm

21.5090.26  
26.0cm

MASSON-LUETHY

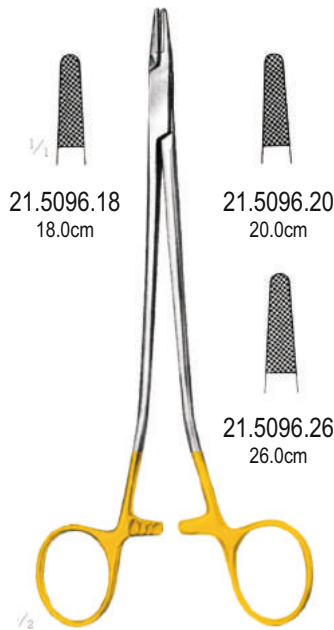

21.5096.18  
18.0cm

21.5096.20  
20.0cm

21.5096.26  
26.0cm

SAROT

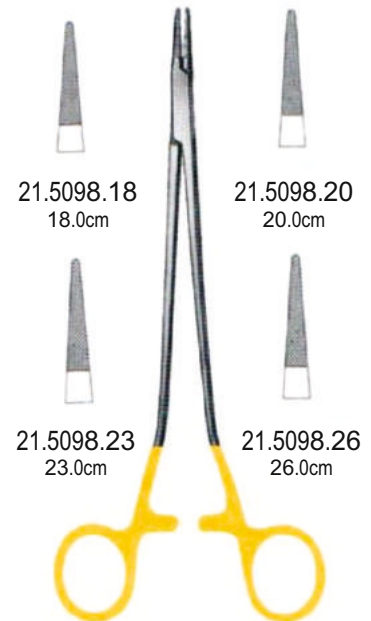

21.5098.18  
18.0cm

21.5098.20  
20.0cm

21.5098.23  
23.0cm

21.5098.26  
26.0cm

SAROT  
Delicate

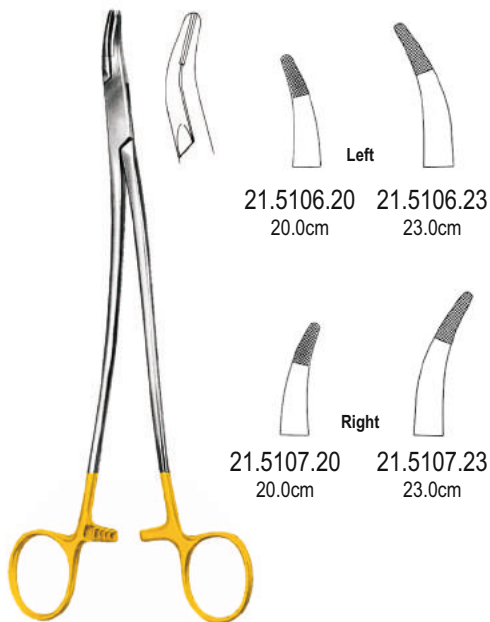

21.5106.20  
20.0cm

Left  
21.5106.23  
23.0cm

21.5107.20  
20.0cm

Right  
21.5107.23  
23.0cm

STRATTE



21.5108.23  
Left

21.5109.23  
Right

STRATTE  
23.0cm



KILNER  
21.5116.13 13.5cm  
21.5116.16 16.5cm

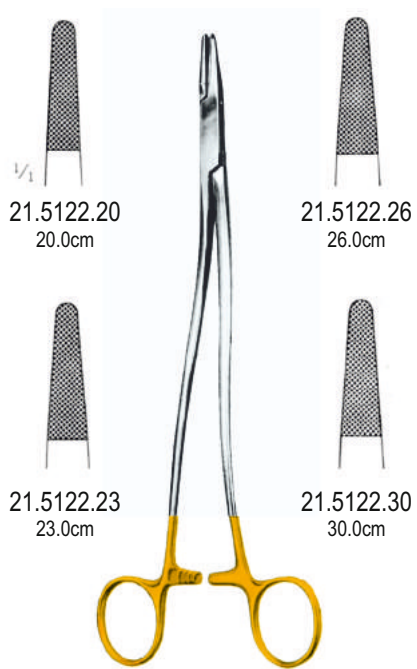

**BOZEMANN**



**FINOCCHIETTO**

- 21.5136.18 18.0cm
- 21.5136.20 20.0cm
- 21.5136.27 27.0cm



**MASSON**

- 21.5140.20 20.0cm
- 21.5140.25 25.0cm
- 21.5140.27 27.0cm

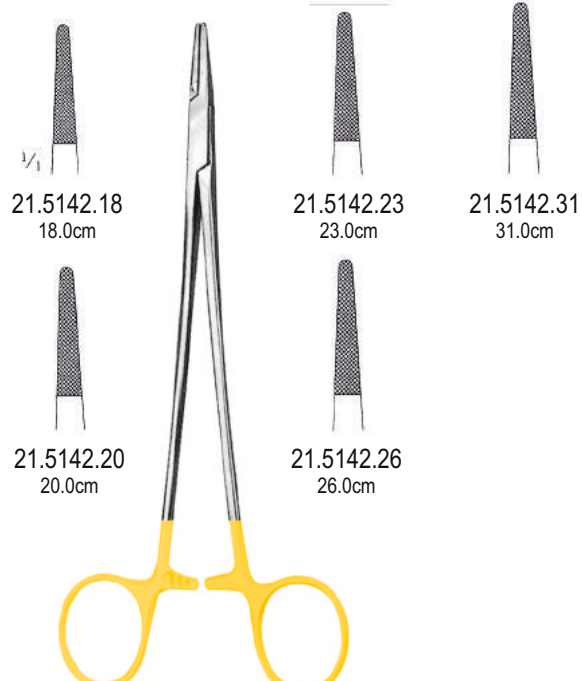

**DeBakey**

- 21.5142.37 37.0cm



**WANGENSTEEN**  
21.5144.27 27.0cm



**JAMISON**  
21.5150.23 23.5cm



**M.G.H. (mass-general-hospital)**  
21.5156.17 17.0cm



**GILLIES MINI**  
21.5158.14 14.0cm



**GILLIES**  
21.5160.16 16.0cm  
21.5161.16 16.0cm (left hand)

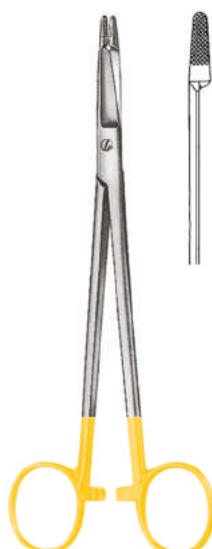

**OLSEN-HEGAR**  
21.5164.16 16.0cm

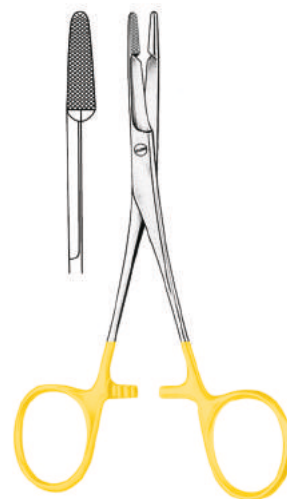

**OLSEN-HEGAR**  
21.5172.14 17.0cm



**OLSEN-HEGAR**  
21.5174.14 14.0cm  
21.5174.17 17.0cm



**OLSEN-HEGAR**  
21.5178.12 12.0cm  
21.5178.14 14.0cm  
21.5178.18 18.0cm



**CRILE**  
21.5180.15 15.0cm



**TOENNIS**  
21.5186.18 18.0cm



**LICHTENBERG**  
21.5190.20 20.0cm



**MATHIEU**  
21.5200.14 14.0cm  
21.5200.17 17.0cm  
21.5200.20 20.0cm  
21.5200.24 24.0cm



**MATHIEU**  
21.5204.14 14.0cm  
21.5204.17 17.0cm  
21.5204.20 20.0cm



**MATHIEU**



**BARRAQUER**  
21.5210.16 16.0cm

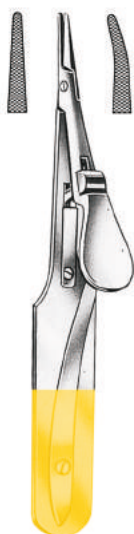

**ARRUGA**  
21.5214.14 14.0cm  
21.5215.14 14.0cm

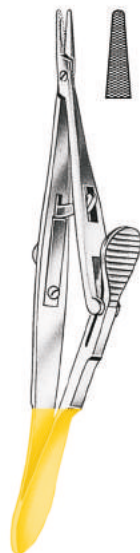

**KALT**  
21.5220.14 14.0cm



**KALT-ARRUGA**  
21.5224.14 14.0cm

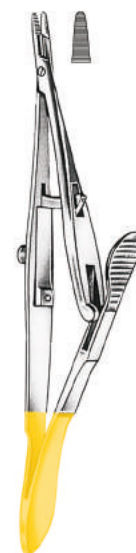

**CASTROVIEJO-KALT**  
21.5226.13 13.5cm





**BOYNTON**  
21.5230.12 12.0cm



**ARRUGA**  
21.5234.16 16.0cm  
21.5235.16 16.0cm



**STEVENSON**  
21.5240.11 11.0cm



**STEVENS**  
21.5246.13 13.0cm  
21.5246.15 15.0cm



**WECKER**  
21.5250.15 15.0cm



**BARRAQUER**  
21.5256.14 14.0cm



**CASTROVIEJO**  
21.5260.09 9.0cm



**CASTROVIEJO**  
21.5261.09 9.0cm

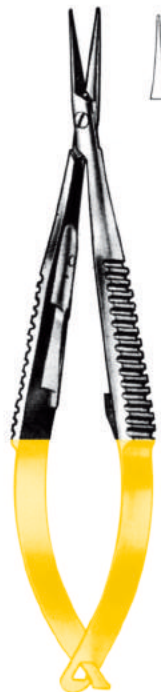

**CASTROVIEJO**  
21.5262.09 9.0cm



**CASTROVIEJO**  
21.5263.09 9.0cm



**CASTROVIEJO**  
21.5262.14 14.0cm



**CASTROVIEJO**  
21.5263.14 14.0cm



**BARRAQUER**  
21.5266.10 10.0cm



**BARRAQUER**  
21.5267.10 10.0cm



**BARRAQUER-TROUTMAN**  
21.5270.10 10.0cm

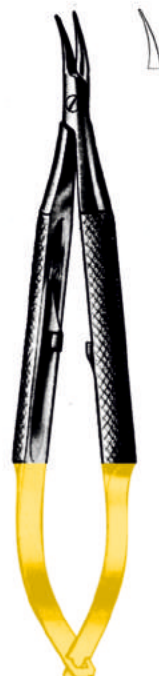

**BARRAQUER-TROUTMAN**  
21.5271.10 10.0cm

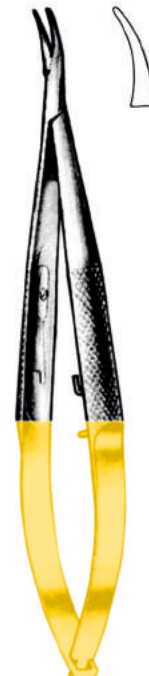

**BARRAQUER**  
21.5276.14 14.0cm

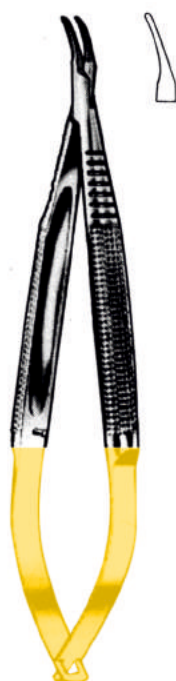

**BARRAQUER**  
21.5277.13 13.0cm

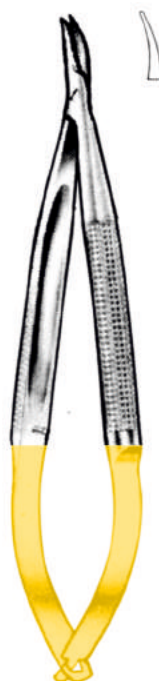

**BARRAQUER**  
21.5280.11 11.0cm

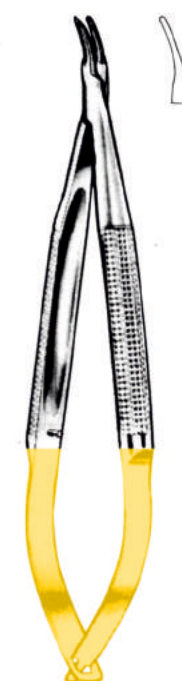

**BARRAQUER**  
21.5282.13 13.0cm



**CASTROVIEJO**

21.5300.14 14.0cm 21.5302.14  
21.5300.17 17.0cm 21.5302.17



**CASTROVIEJO**

21.5301.14 14.0cm 21.5303.14  
21.5301.17 17.0cm 21.5303.17



**CASTROVIEJO**

21.5304.14 14.0cm 21.5306.14  
21.5304.17 17.0cm 21.5306.17



**CASTROVIEJO**

21.5305.14 14.0cm 21.5307.14  
21.5305.17 17.0cm 21.5307.17



**JACOBSON**  
21.5310.18 18.5cm  
21.5310.21 21.0cm



**JACOBSON**  
21.5314.18 18.5cm  
21.5314.21 21.0cm

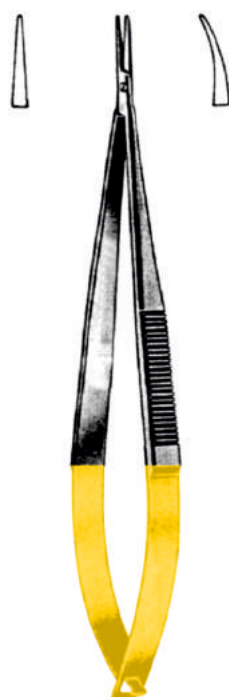

**CASTROVIEJO**  
21.5320.10 10.0cm 21.5321.10



**CASTROVIEJO**  
21.5324.10 10.0cm 21.5325.10



**INTRACARDIAC**



21.5700.18  
18.0cm



21.5700.20  
20.0cm



21.5700.23  
23.0cm



21.5700.26  
26.0cm

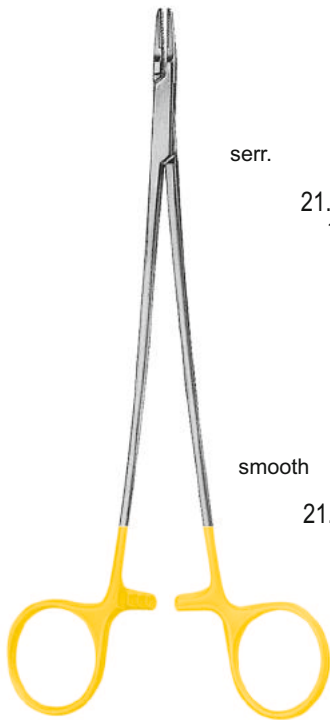

**MICRO-RYDER**

21.5710.26 26.0cm 21.5712.26

serr.



21.5710.13  
13.0cm

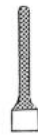

21.5710.15  
15.0cm



21.5710.18  
18.0cm



21.5710.20  
20.0cm



21.5710.23  
23.0cm

smooth



21.5712.13  
13.0cm



21.5712.15  
15.0cm



21.5712.18  
18.0cm



21.5712.20  
20.0cm



21.5712.23  
23.0cm

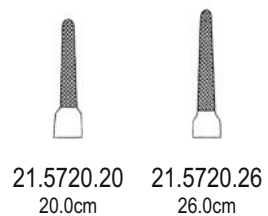
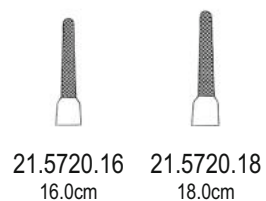
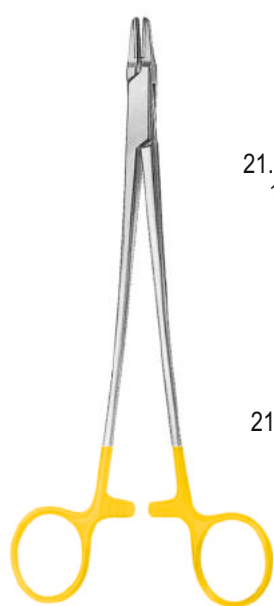

FRENCH EYE (RYDER)

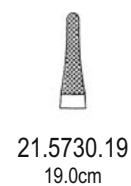
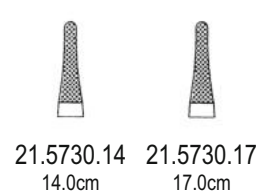
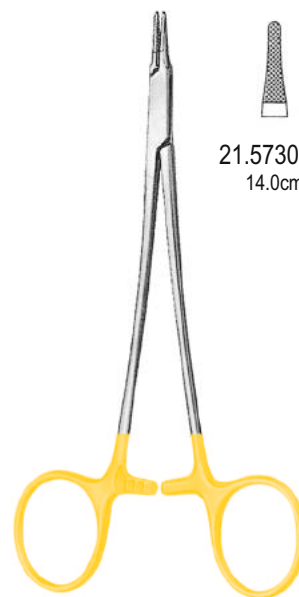

LEMMON

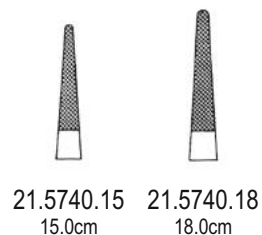
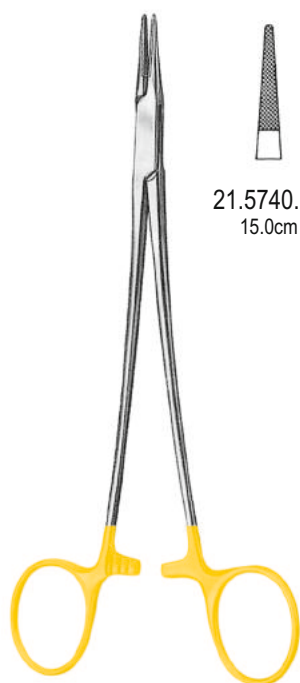

MICRO-VASCULAR

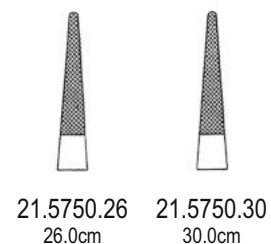
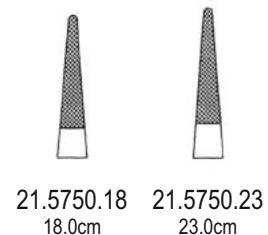
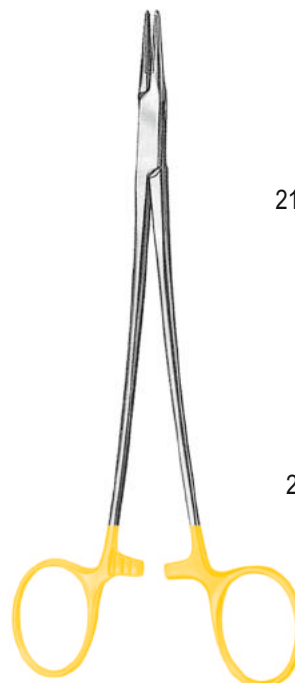

DeBakey

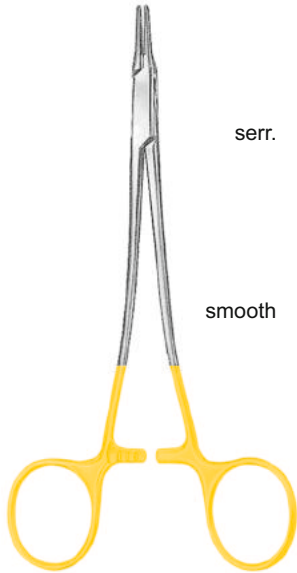

EUFRATE-PASQUE

serr. 21.5760.14  
14.0cm



21.5760.15  
15.0cm



21.5760.18  
18.0cm



21.5760.20  
20.0cm



smooth 21.5762.14  
14.0cm



21.5762.15  
15.0cm



21.5762.18  
18.0cm



21.5762.20  
20.0cm

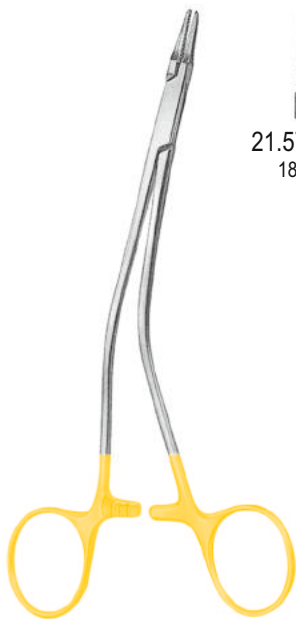

PARELL

21.5770.18  
18.0cm



SWEDISH

21.5780.14  
14.0cm

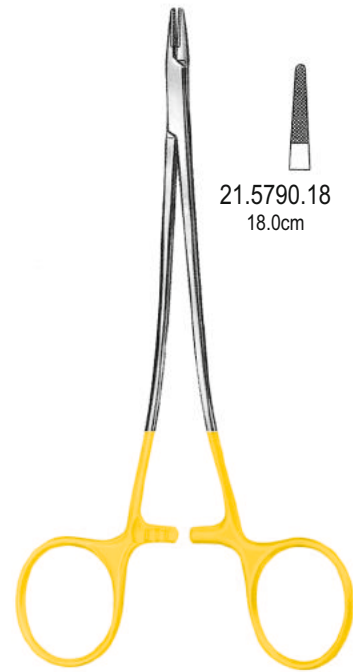

SENNING

21.5790.18  
18.0cm





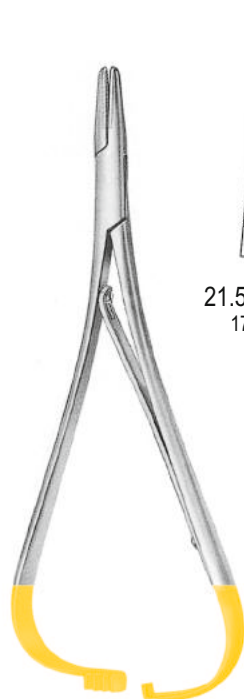

21.5800.17  
17.0cm

21.5800.19  
19.0cm

MATHIEU-STILLE



21.5820.20  
20.0cm

LANGENBECK



21.5830.16  
16.0cm

21.5830.18  
18.0cm

21.5830.20  
20.0cm

LANGENBECK



21.5840.20  
20.0cm

21.5840.23  
23.0cm

ZWEIFEL



**LUTHY-BECK**

21.5850.20 20.0cm  
21.5850.23 23.0cm



21.5850.25  
25.0cm



**HOSEL**

21.5860.20 20.0cm  
21.5860.23 23.0cm



21.5860.25  
25.0cm

smooth



21.5870.16

serr.



21.5872.16



21.5871.16



21.5873.16

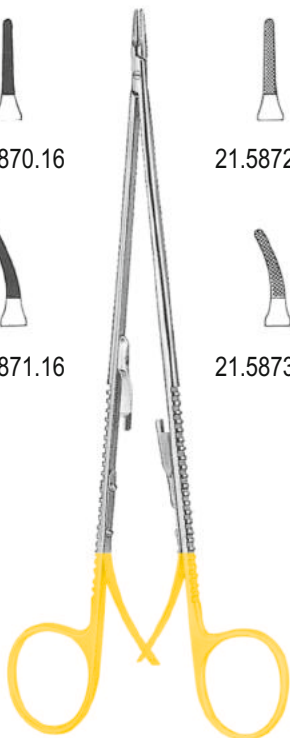

**MAYO-CASTROVIEJO**

16.0cm

smooth



21.5880.18  
21.5880.20

serr.



21.5882.18  
21.5882.20



21.5881.18  
21.5881.20



21.5883.18  
21.5883.20



**CASTROVIEJO**

18.0cm  
20.0cm



GIANNINI

smooth



21.5900.13  
13.0cm



21.5901.13  
13.0cm

serr.



21.5902.13  
13.0cm



21.5903.13  
13.0cm



CASTROVIEJO

smooth



21.5910.13  
13.0cm

serr.



21.5912.13  
13.0cm

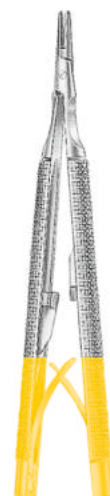

CASTROVIEJO

smooth



21.5920.18  
18.0cm

serr.



21.5922.18  
18.0cm



HEPP-SCHIEDL



**MICRO-CASTROVIEJO**

1.2	1.2	smooth	1.2	1.2
21.5930.14	14.0cm	21.5931.14	21.5932.14	14.0cm 21.5933.14
1.2	1.2	serr.	1.2	1.2
21.5930.15	15.0cm	21.5931.15	21.5932.15	15.0cm 21.5933.15



**MICRO-CASTROVIEJO**  
(with catch lock)

1.2	1.2	smooth	1.2	1.2
21.5934.14	14.0cm	21.5935.14	21.5936.14	14.0cm 21.5937.14
1.2	1.2	serr.	1.2	1.2
21.5934.15	15.0cm	21.5935.15	21.5936.15	15.0cm 21.5937.15



**MICRO-CASTROVIEJO**

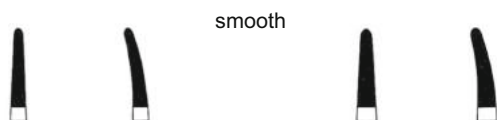

smooth

21.5970.18	21.5971.18	18cm	21.5972.18	21.5973.18
21.5970.21	21.5971.21	21cm	21.5972.21	21.5973.21
21.5970.23	21.5971.23	23cm	21.5972.23	21.5973.23



serr.

21.5974.18	21.5975.18	18cm	21.5976.18	21.5977.18
21.5974.21	21.5975.21	21cm	21.5976.21	21.5977.21
21.5974.23	21.5975.23	23cm	21.5976.23	21.5977.23



**MICRO-CASTROVIEJO**  
(with catch lock)

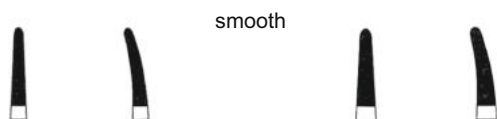

smooth

21.5990.18	21.5991.18	18cm	21.5992.18	21.5993.18
21.5990.21	21.5991.21	21cm	21.5992.21	21.5993.21
21.5990.23	21.5991.23	23cm	21.5992.23	21.5993.23



serr.

21.5994.18	21.5995.18	18cm	21.5996.18	21.5997.18
21.5994.21	21.5995.21	21cm	21.5996.21	21.5997.21
21.5994.23	21.5995.23	23cm	21.5996.23	21.5997.23