

# 46

Страницы раздела  
001-034

## РИНОЛОГИЯ RHINOLOGY

Перейти в **СОДЕРЖАНИЕ**

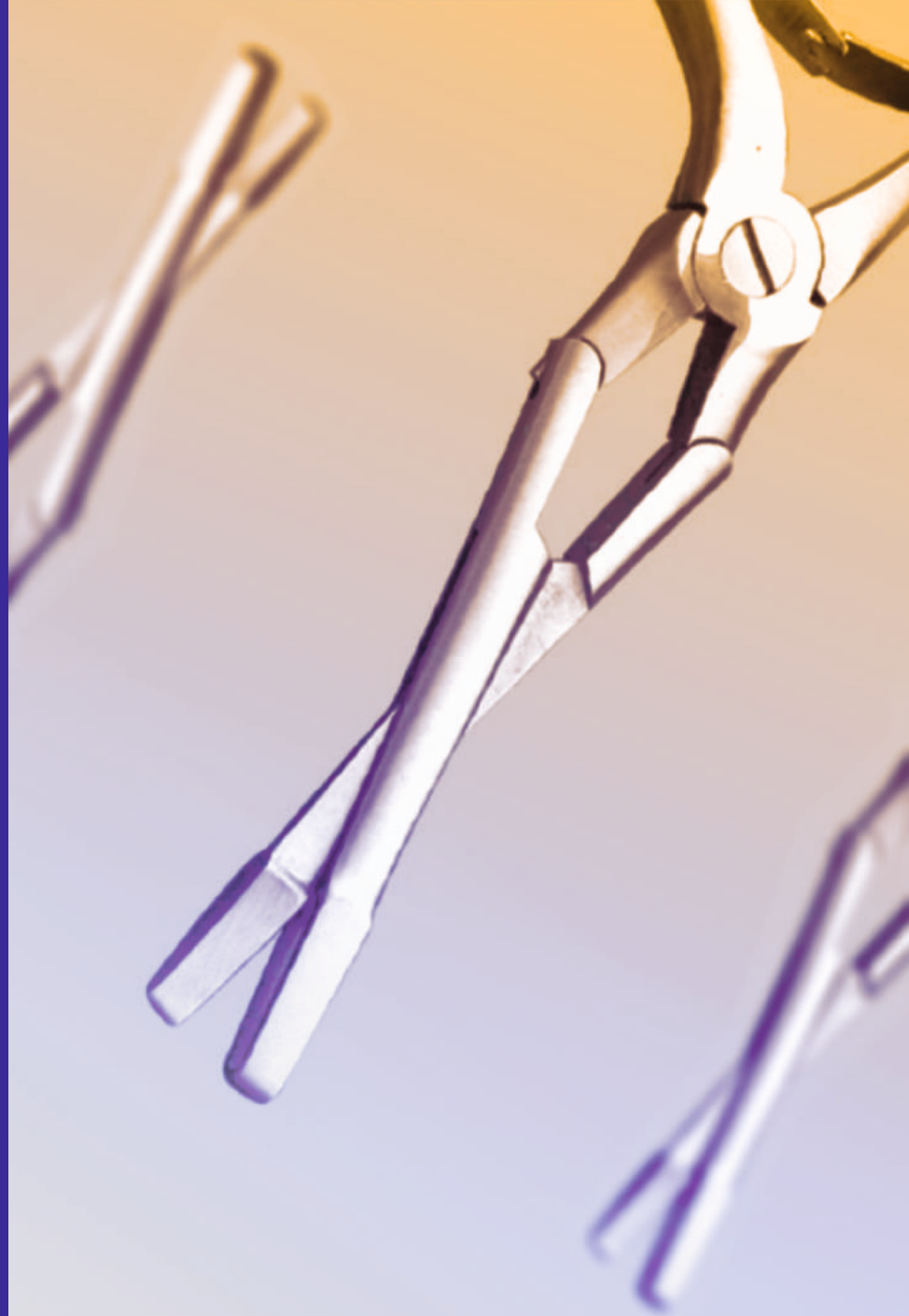

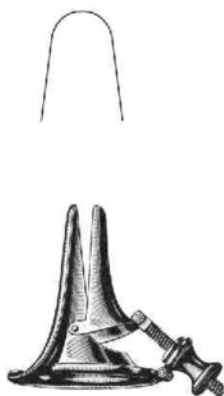

**VACHER**  
46.0010.00



**VOLTOLINI**



1 46.0014.01



2 46.0014.02



3 46.0014.03

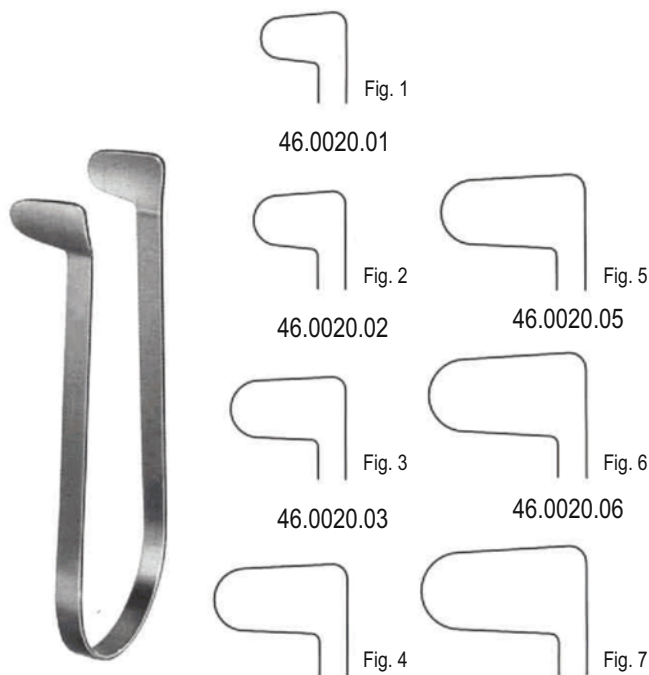

Fig. 1  
46.0020.01

Fig. 2  
46.0020.02

Fig. 3  
46.0020.03

Fig. 4  
46.0020.04

Fig. 5  
46.0020.05

Fig. 6  
46.0020.06

Fig. 7  
46.0020.07

**GOLDSMITH (Thudichum)**  
46.0020.00 set / 7

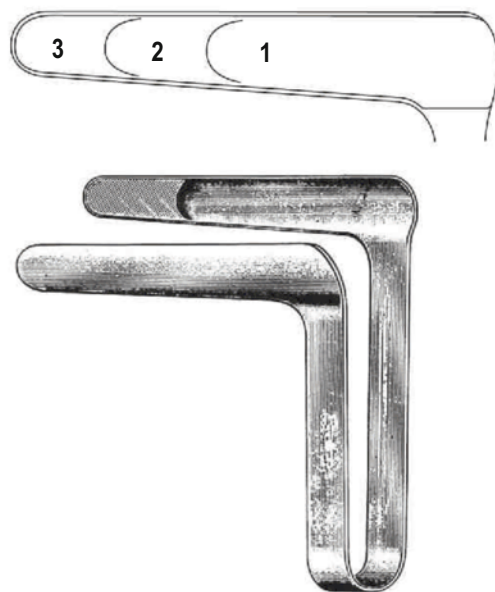

**ST. CLAIR THOMSON**  
46.0024.00 set / 3  
46.0024.01 35mm Fig. 1  
46.0024.02 50mm Fig. 2  
46.0024.03 75mm Fig. 3



**HARTMANN-HALLE**

15.0cm

- 46.0030.01 Fig. 1
- 46.0030.02 Fig. 2
- 46.0030.03 Fig. 3

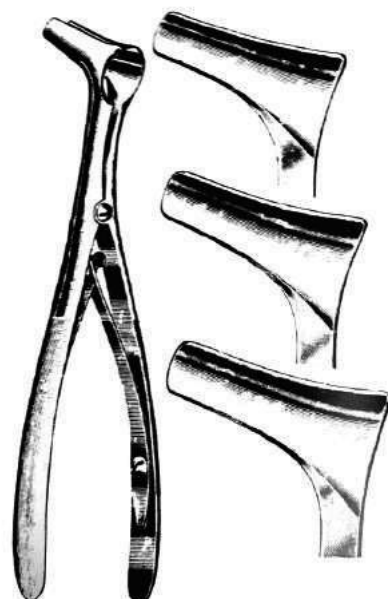
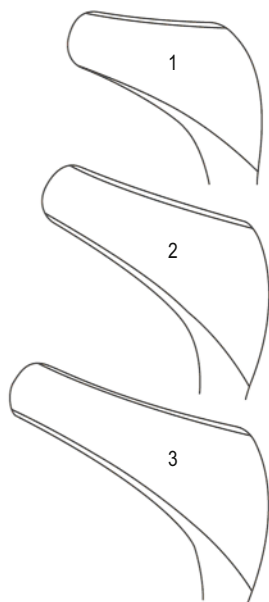

**HARTMANN**

16.5cm

- 46.0032.01 Fig. 1
- 46.0032.02 Fig. 2
- 46.0033.03 Fig. 3

Fig. 1

2

3

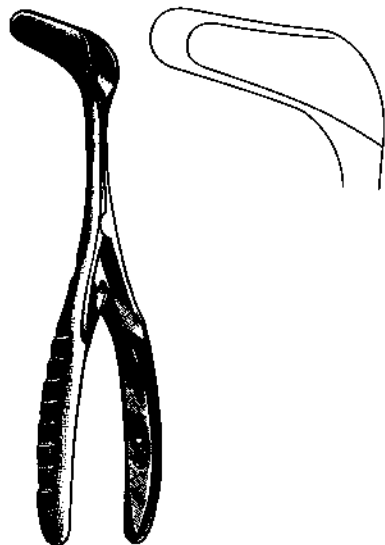

**SCHWARZ**

46.0036.14 14.0cm

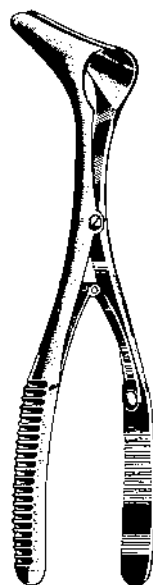
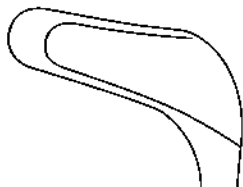

**VIENNA**

14.5cm

- 46.0040.01 (infant)
- 46.0040.02 (child)
- 46.0040.03 (adult)
- 46.0040.04 (sheet metal)



**MOD WIEN**

46.0044.14 14.5cm



Pediatrics

46.0048.13 13.0cm



46.0049.13 13.0cm

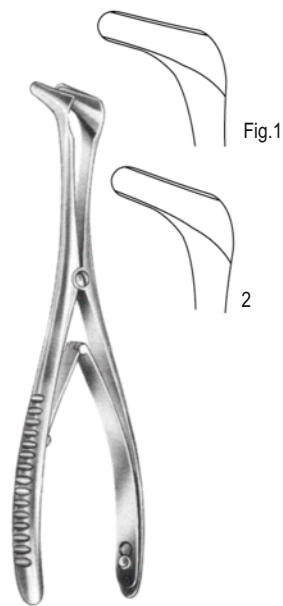

**TIECK-HALLE**  
13.5cm  
46.0052.01  
46.0052.02



**TIECK-HALLE**  
46.0056.13 13.5cm



**KILLIAN**  
13.0cm  
46.0060.35  
46.0060.50  
46.0060.75  
46.0060.90

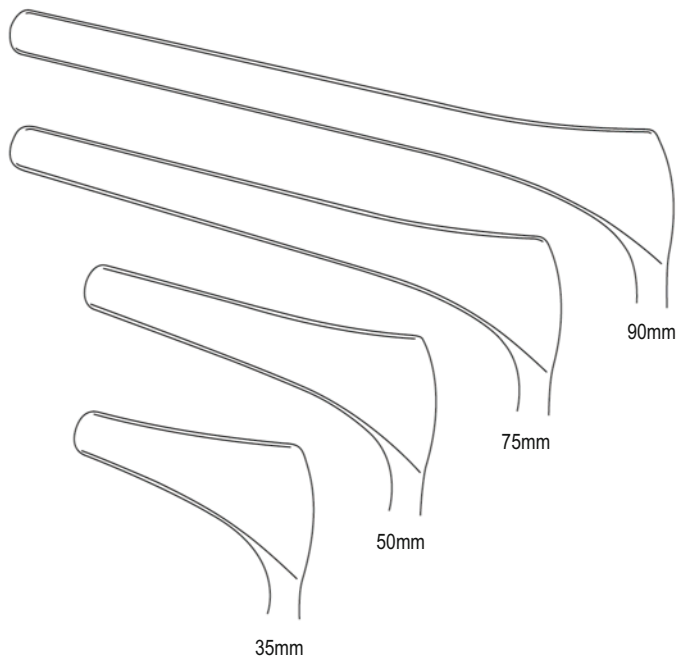

**KILLIAN (with side screw)**  
13.0cm  
46.0062.35  
46.0062.50  
46.0062.75  
46.0062.90





**COTTLE**

15.0cm  
46.0070.35  
46.0070.50  
46.0070.75  
46.0070.90

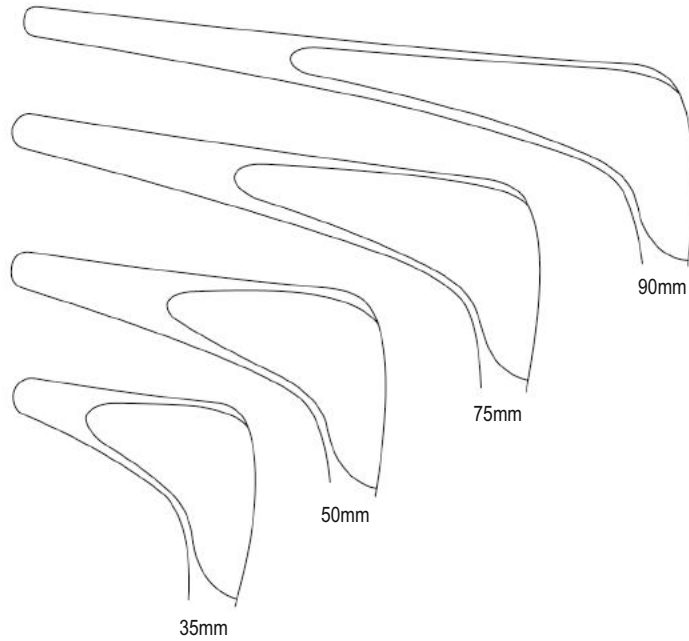

**COTTLE (with side screw)**

15.0cm  
46.0072.35  
46.0072.50  
46.0072.75  
46.0072.90



**COTTLE**  
(dull black chromium plated)  
14.0cm

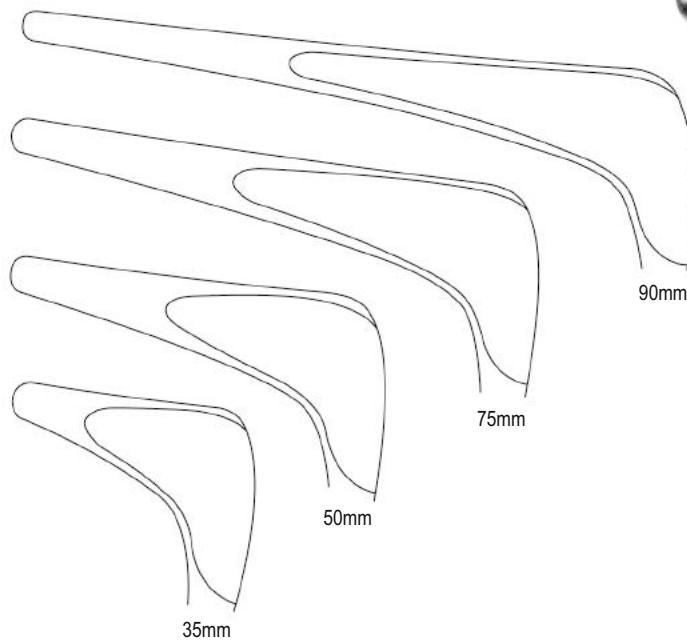

46.0076.35  
46.0076.50  
46.0076.75  
46.0076.90

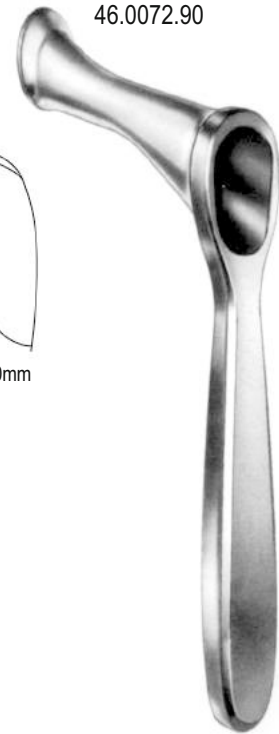

**YANKAUER**  
46.0080.19 19.0cm



44.0270.03 0.3mm Ø  
44.0270.04 0.4mm Ø



44.0274.02 0.2mm Ø  
44.0274.03 0.3mm Ø



**KRAUSE**  
46.0100.26 26.0cm

**KRAUSE-VOSS**  
46.0104.26 26.0cm

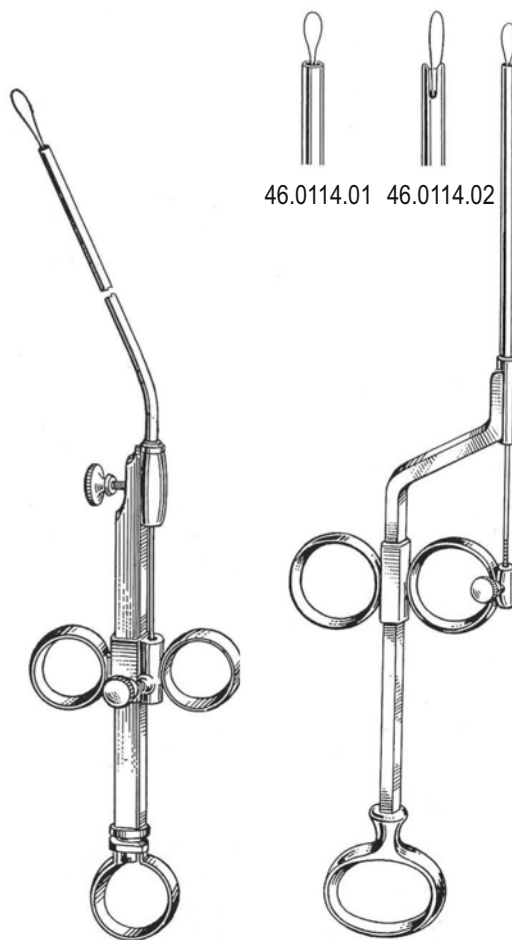

46.0114.01 46.0114.02

**KRAUSE**  
46.0110.00

**GLEGG**



**KILLIAN**  
46.0120.17 17.0cm



**LITTAUER**  
46.0124.18 18.0cm



**HARTMANN**  
46.0130.20 20.0cm



**QUIRE**  
46.0134.12 12.0cm

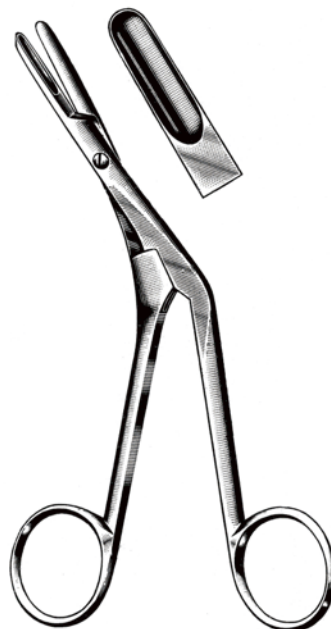

**GRAIG**  
46.0140.18 18.0cm



46.0144.01 46.0144.02

18.0cm



**KNIGHT**  
46.0150.18 18.0cm

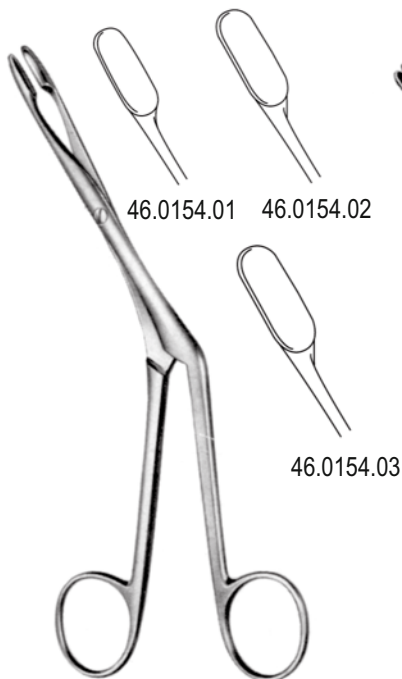

**HEYMANN**  
18.0cm

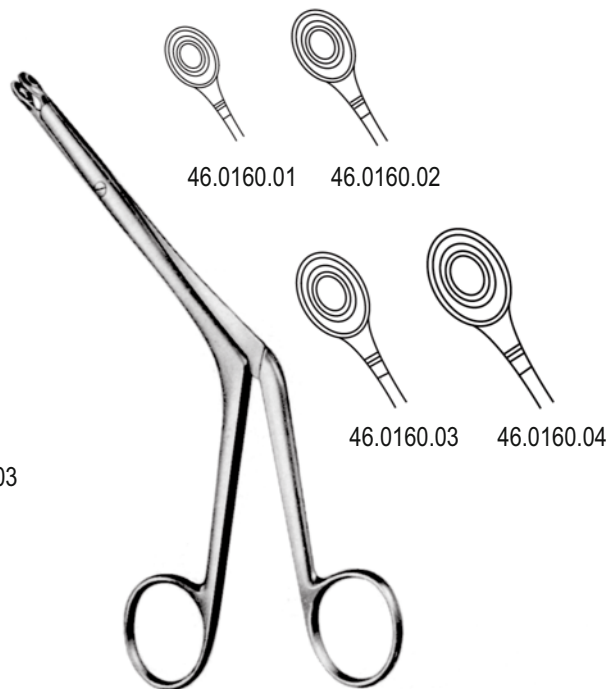

**BRUENINGS**  
19.0cm

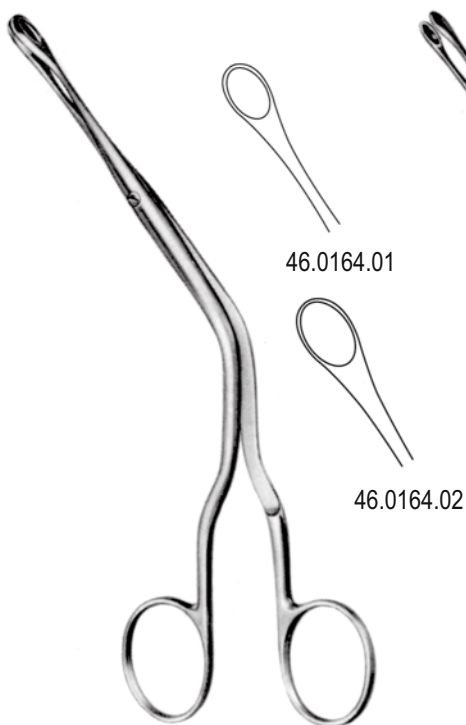

**LUC**  
20.0cm

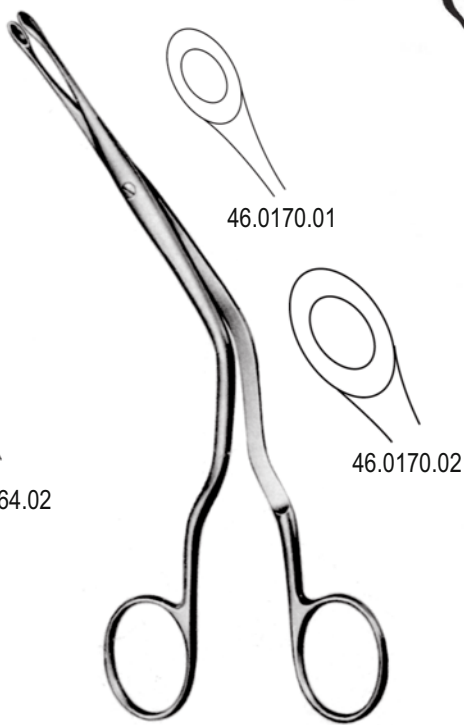

**LUC**  
20.0cm

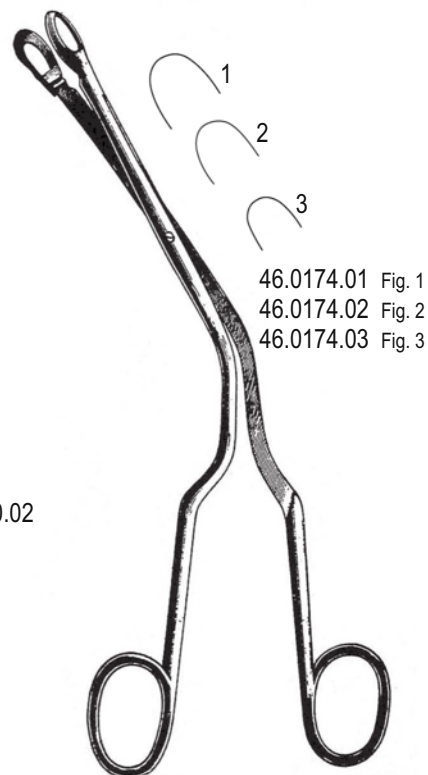

**LUC**  
20.0cm

46.0174.01 Fig. 1  
46.0174.02 Fig. 2  
46.0174.03 Fig. 3

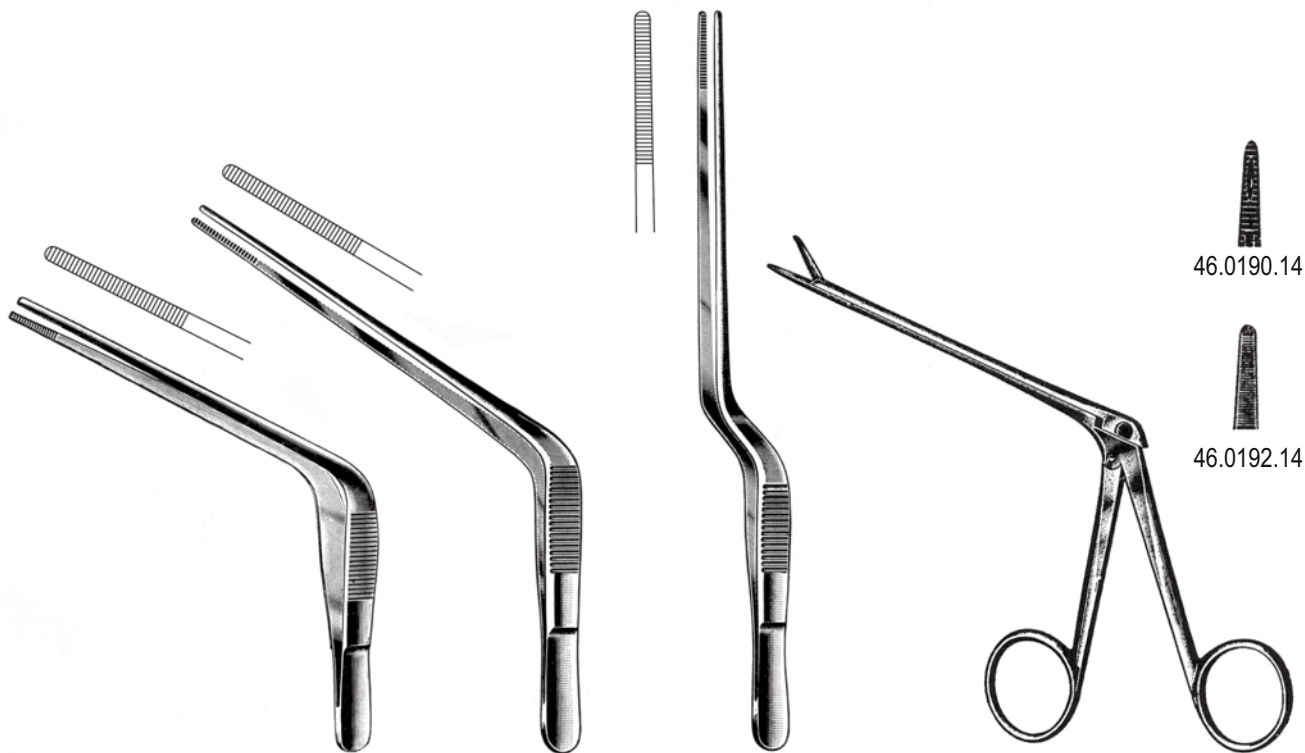

**TROELTSCH**  
46.0180.15 15.0cm

**TROELTSCH**  
46.0182.18 18.0cm

**GRUENWALD (JANSEN)**  
46.0186.20 20.0cm

**NOYES**  
14.5cm

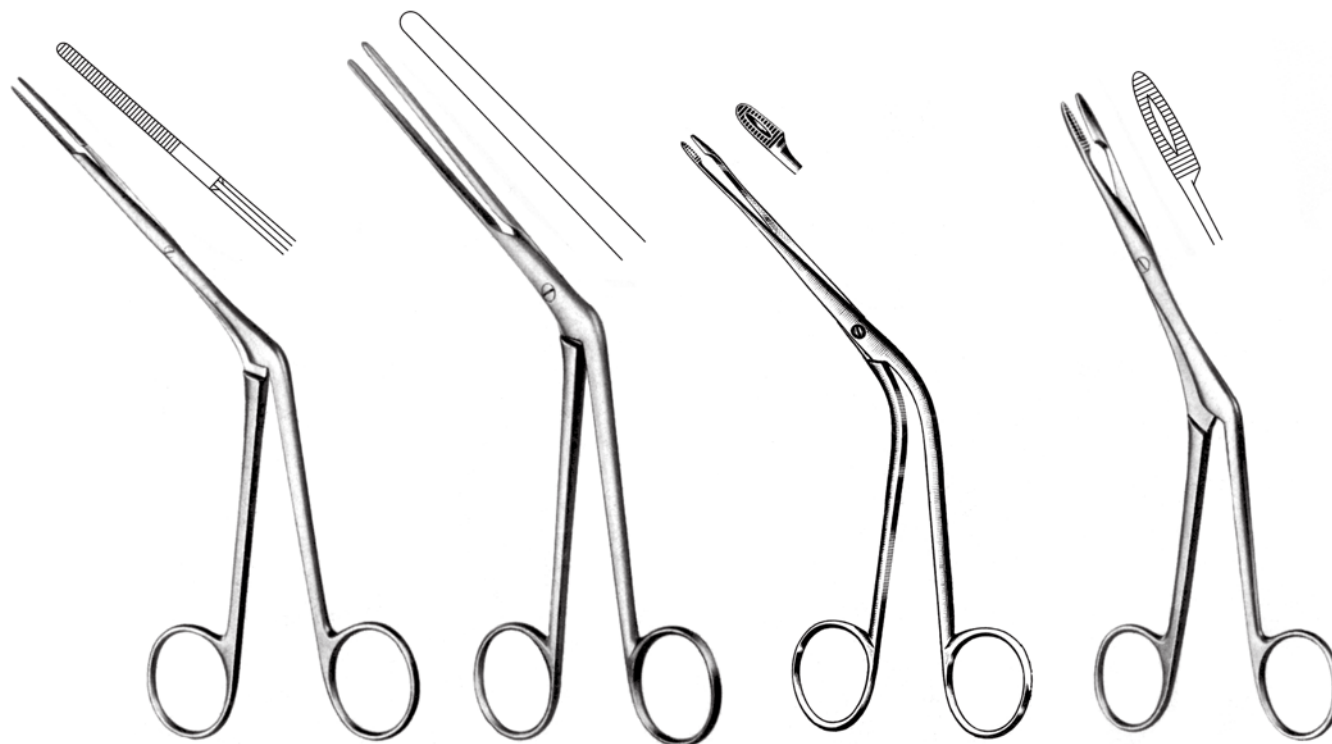

**WESTMACOTT**  
46.0196.20  
20.0cm

**LUBET-BARBON**  
46.0200.20  
20.0cm

**HARTMANN**  
46.0204.16  
16.0cm

**HEYMANN-KNIGHT**  
46.0210.18  
18.0cm

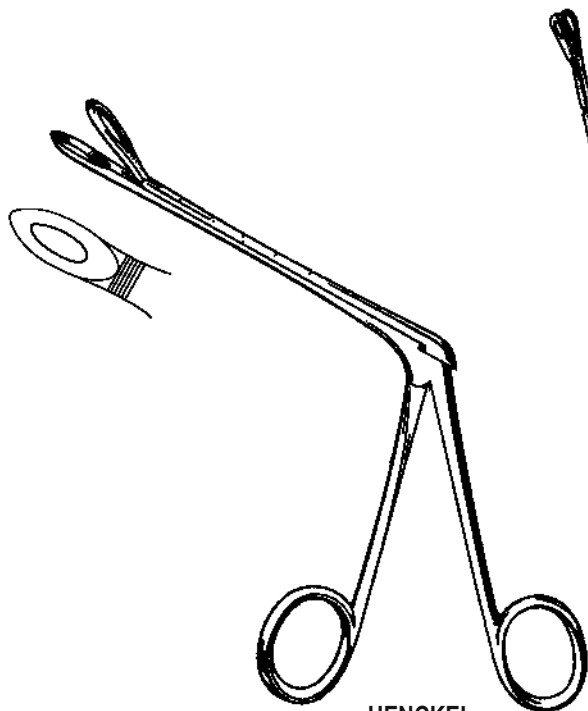

**HENCKEL**  
46.0214.20 20.0cm

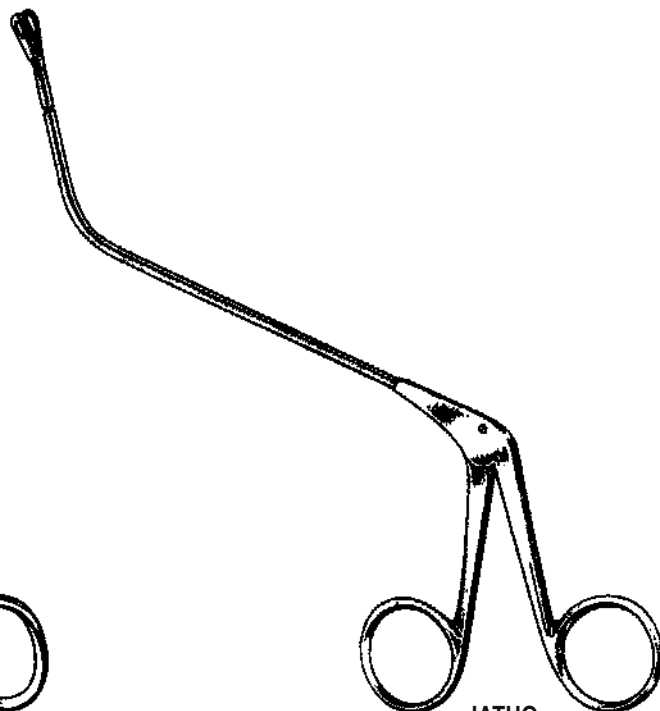

**JATHO**  
46.0220.15 24.0cm

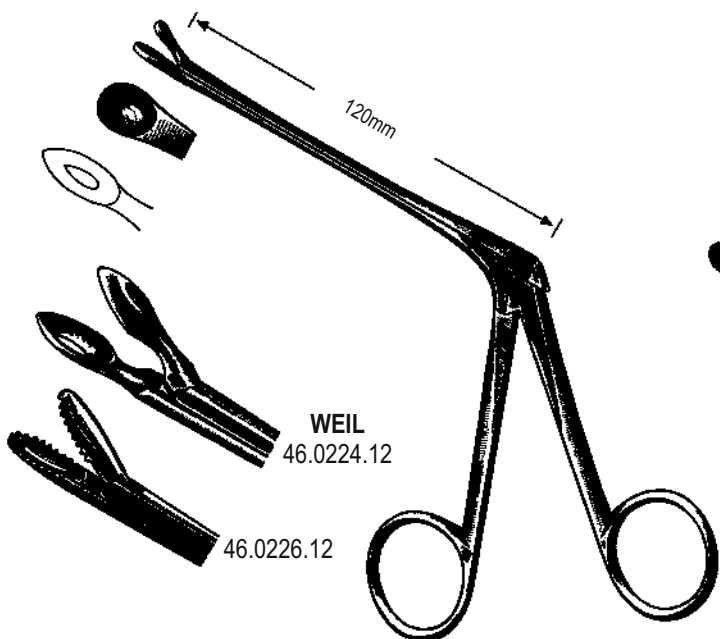

**WATSON-WILLIAMS**  
46.0222.12 19.0cm

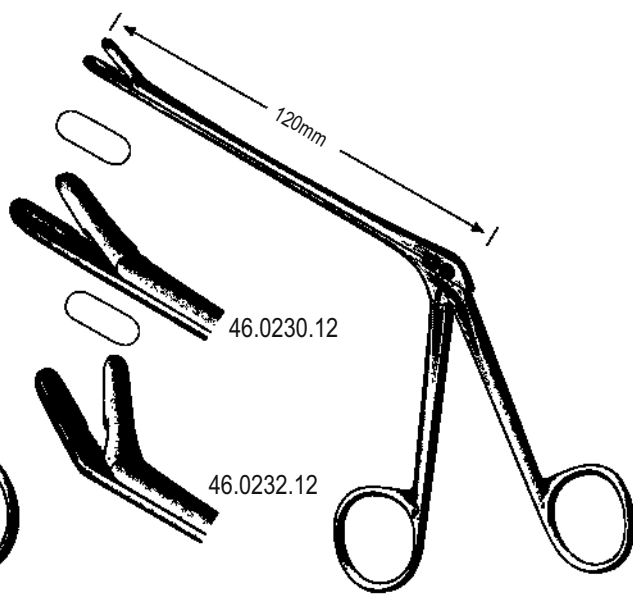

**TAKAHASHI**  
19.0cm

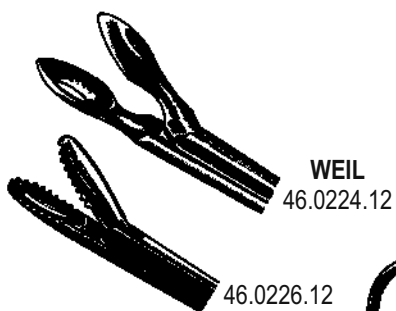

**WEIL**  
46.0224.12

46.0226.12

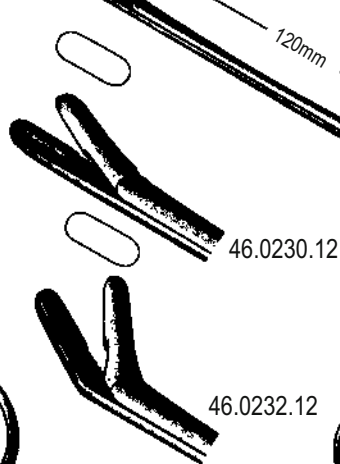

46.0230.12

46.0232.12



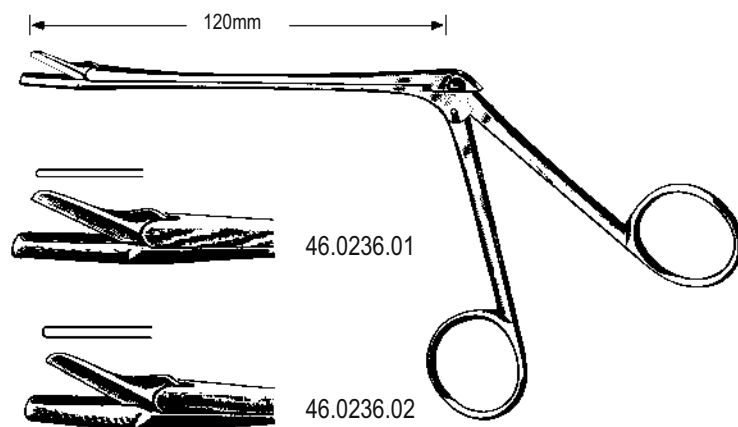

**STRUYCKEN**  
19.0cm

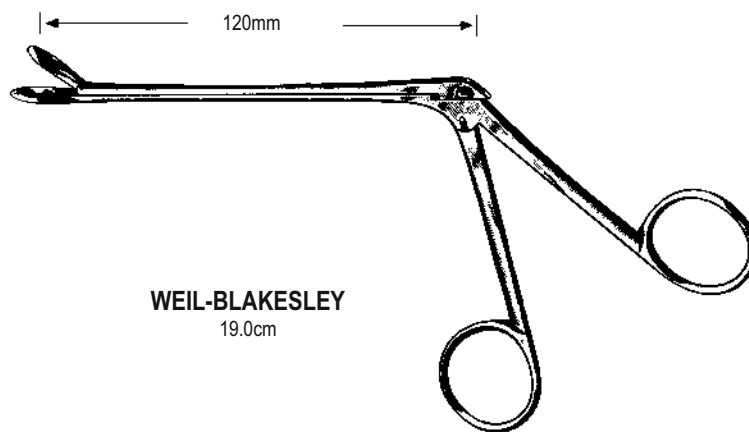

**WEIL-BLAKESLEY**  
19.0cm



# 46 | Щипцы носовые режущие

Nasal Cutting Forceps

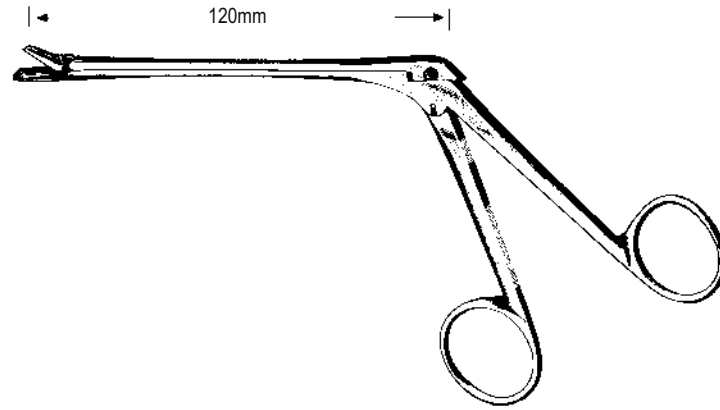

**HAJEK**  
19.0cm

46.0250.12

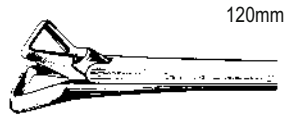

**SCHMEDEN**  
19.0cm

46.0254.12



**HARTMANN**  
19.0cm

 46.0260.01 5mm	 46.0260.02 7mm
 46.0260.03 9mm	 46.0260.04 11mm

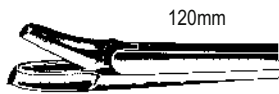

**MYLES**  
19.0 cm

 46.0264.01 2.2mm	 46.0264.02 2.6mm	 46.0270.01 5mm	 46.0270.02 7mm
 46.0264.03 3mm	 46.0264.04 3.4mm	 46.0270.03 9mm	

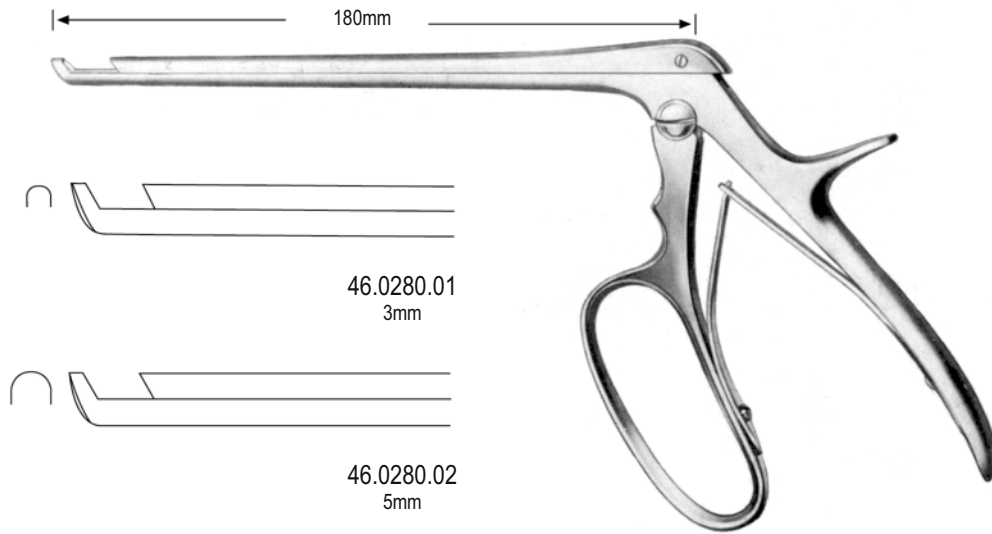

FERRIS-SMITH-KERRISON  
(CLOWARD HARPER)

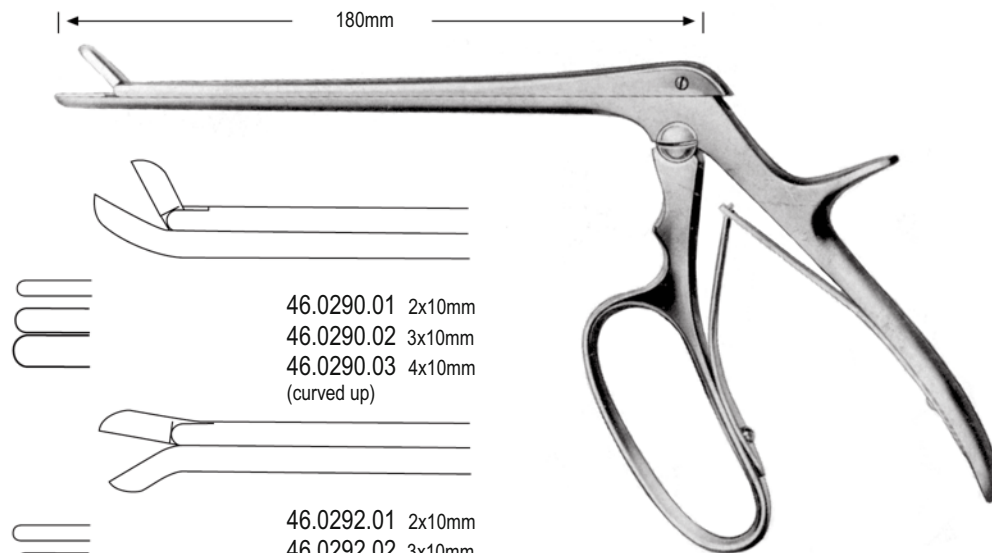

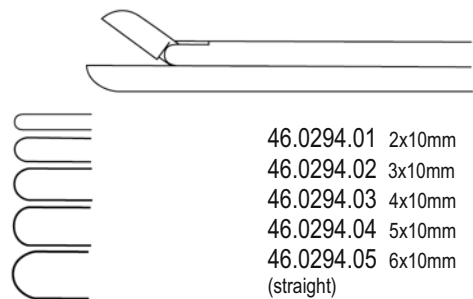

FERRIS-SMITH-CUSHING

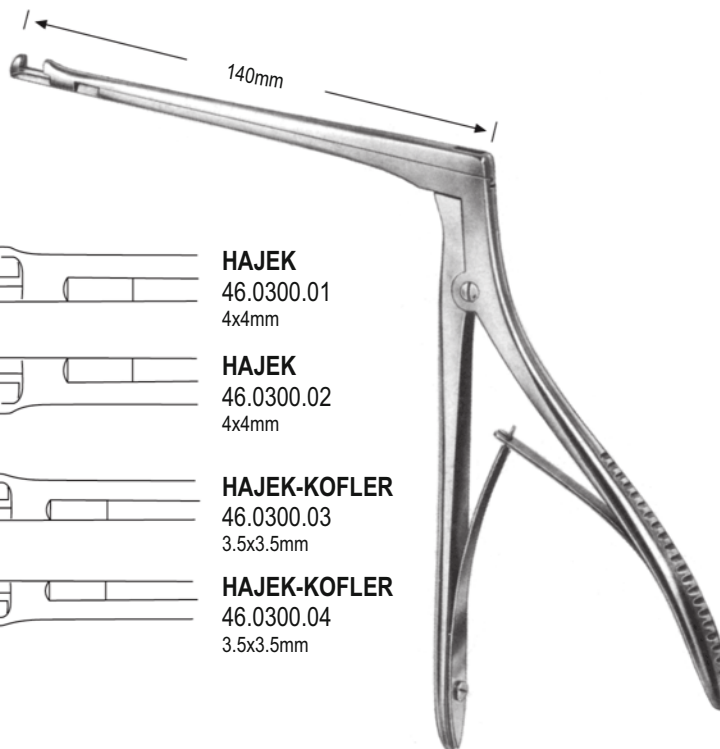

- 46.0294.01 2x10mm
- 46.0294.02 3x10mm
- 46.0294.03 4x10mm
- 46.0294.04 5x10mm
- 46.0294.05 6x10mm  
(straight)



 **HAJEK**  
46.0300.01  
4x4mm

 **HAJEK**  
46.0300.02  
4x4mm

 **HAJEK-KOFLER**  
46.0300.03  
3.5x3.5mm

 **HAJEK-KOFLER**  
46.0300.04  
3.5x3.5mm

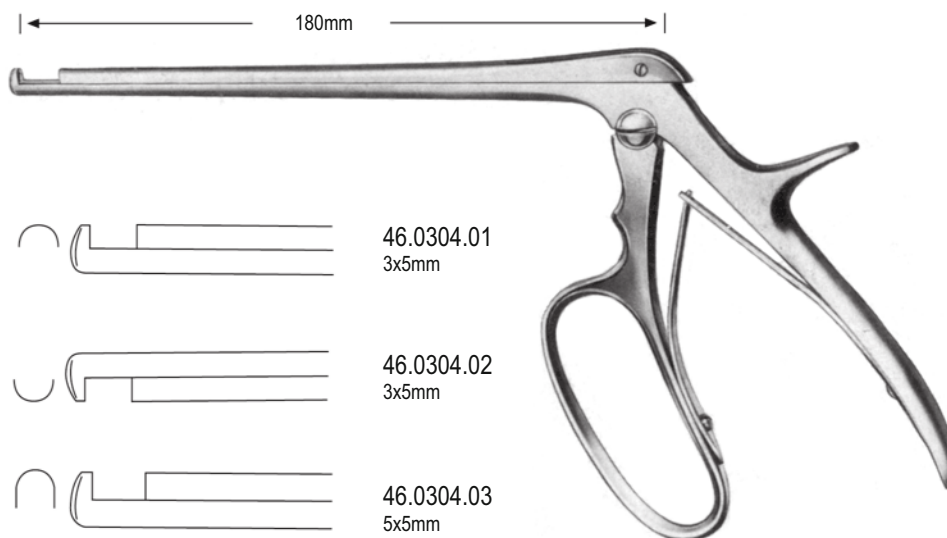

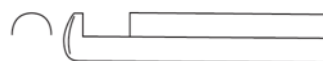
 46.0304.01  
3x5mm

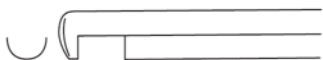
 46.0304.02  
3x5mm

 46.0304.03  
5x5mm

 46.0304.04  
5x5mm

**FERRIS-SMITH-KERRISON**

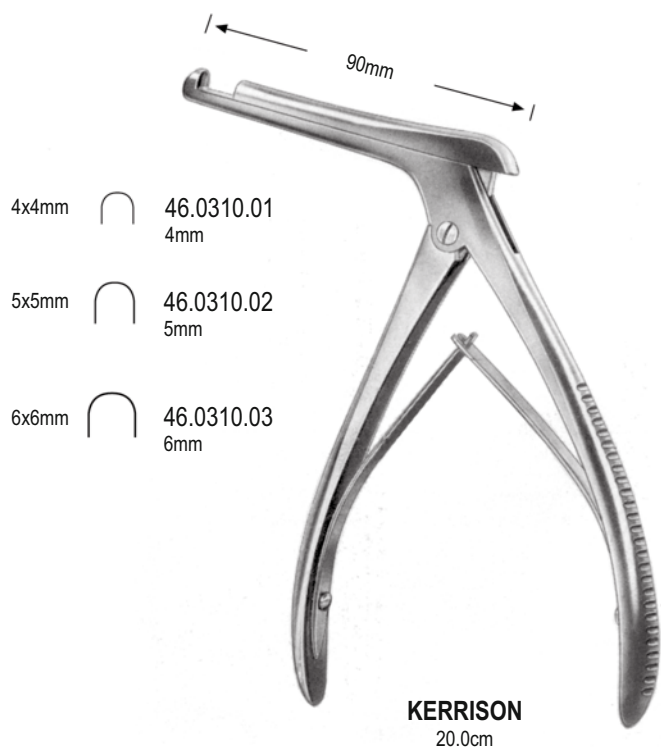

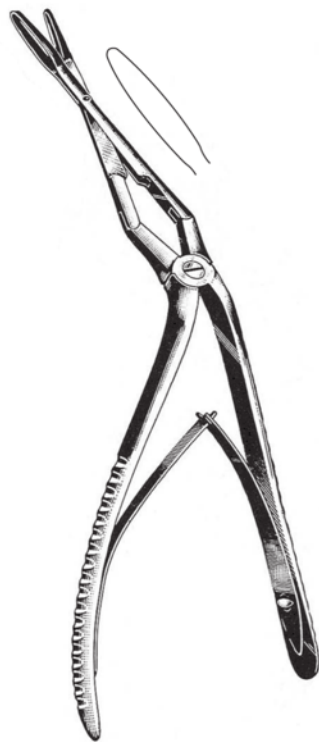

**JANSEN-STRUYCKEN**  
46.0320.19 19.0cm



**MIDDLETON-JANSEN**  
46.0322.19 19.0cm



**MIDDLETON-JANSEN**  
46.0324.19 19.0cm



**CAPLAN**  
46.0330.20  
20.0cm



**KILLIAN**  
46.0334.21  
21.0cm



**RUBIN**  
46.0340.21  
21.0cm



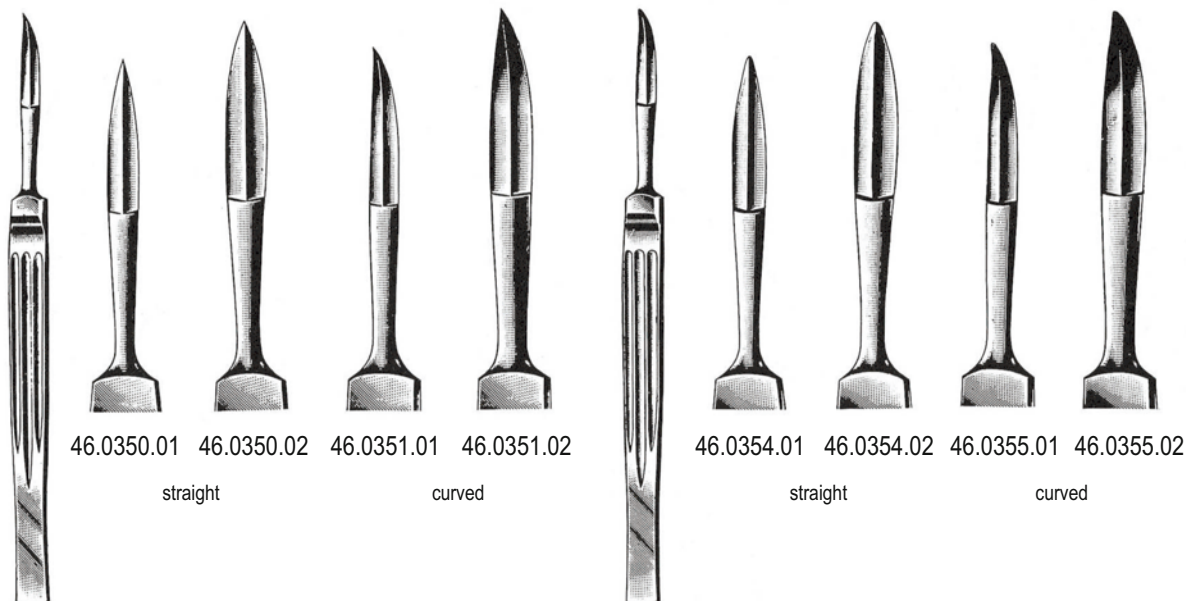

46.0350.01 46.0350.02 46.0351.01 46.0351.02

straight

curved

46.0354.01 46.0354.02 46.0355.01 46.0355.02

straight

curved

**JOSEPH (sharp)**  
15.0cm

**JOSEPH (blunt)**  
15.0cm

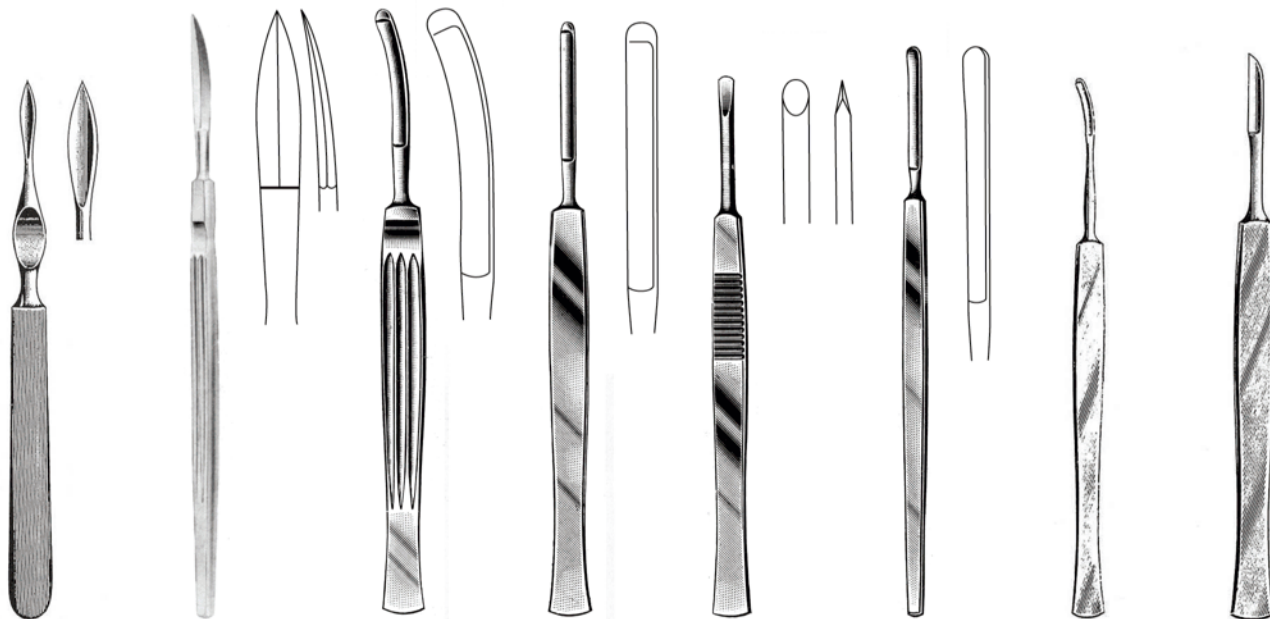

**BALLENGER**  
46.0360.00

**FOMON**  
46.0364.16  
16.0cm

**CONVERSE**  
46.0370.16  
16.0cm

**JOSEPH**  
46.0374.15  
15.0cm

**COTTLE**  
46.0380.15  
15.0cm

**COTTLE**  
46.0384.15  
15.0cm

**HEYMANN**  
46.0390.00

**KRIEG**  
46.0394.00



46.0400.03  
3mm



46.0400.04  
4mm



46.0400.05  
5mm



46.0401.03  
3mm



46.0401.04  
4mm



46.0401.05  
5mm



BALLENGER  
20.0cm



BRUENINGS  
46.0404.16 16.5cm



FREER  
46.0406.00



FREER  
46.0408.15  
15.0cm



FREER  
46.0410.19  
19.0cm



FREER  
46.0412.19  
19.0cm



FREER  
46.0414.19  
19.0cm

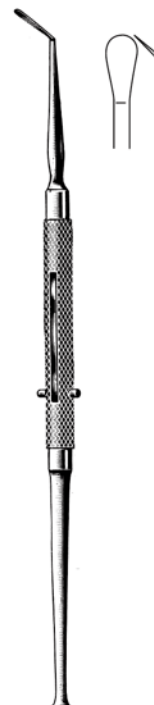

FREER  
46.0416.19  
19.0cm

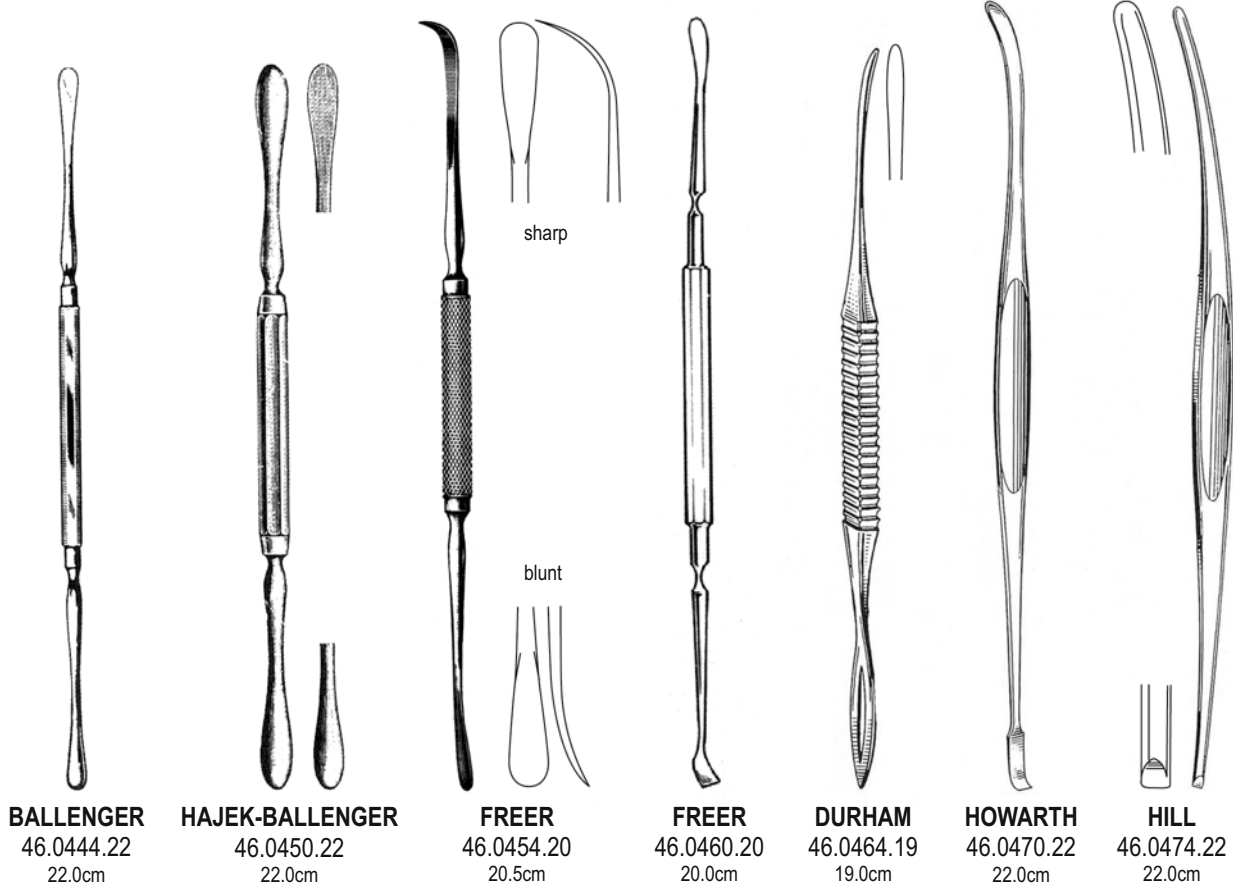
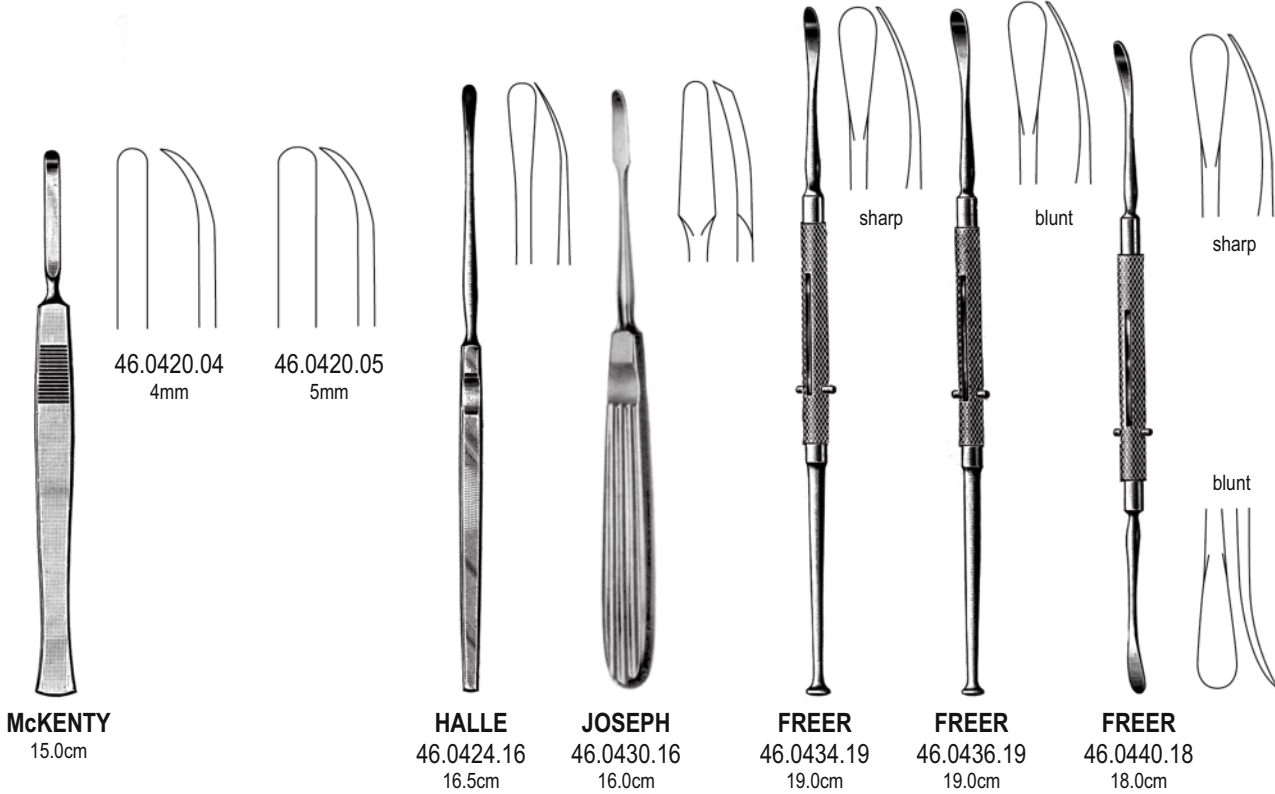

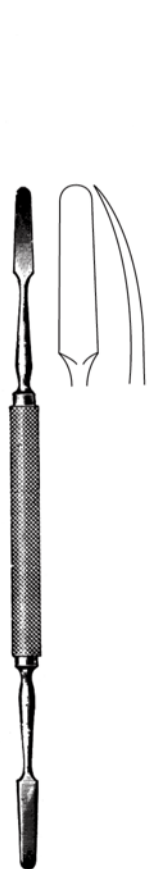

**KILLIAN**  
46.0480.18  
18.0cm

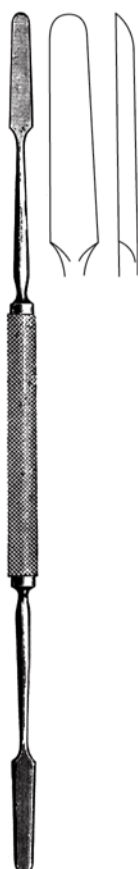

**KILLIAN**  
46.0484.22  
22.0cm



**PIERCE**  
46.0490.21  
21.0cm

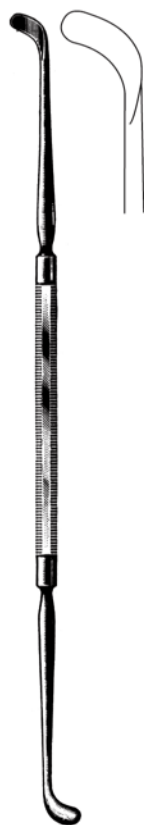

**PENNINGTON**  
46.0494.21  
21.0cm

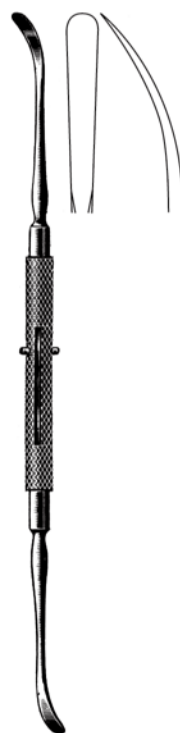

**ROGER**  
46.0500.19  
19.0cm



**McKENTY**  
46.0504.22  
22.0cm



**COTTLE**  
46.0510.23  
23.0cm

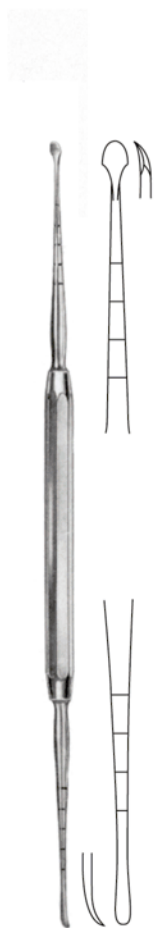

**MASING**  
46.0514.21  
21.0cm



**CARTER**  
46.0520.21  
21.0cm

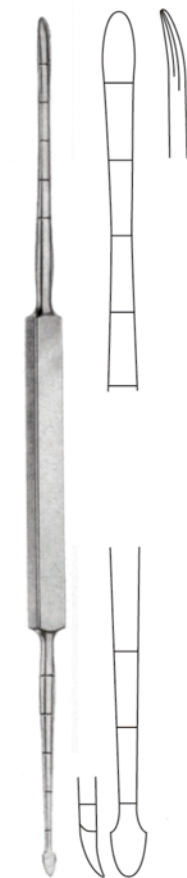

**COTTLE**  
46.0524.21  
21.0cm

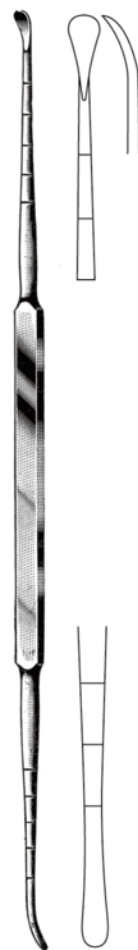

**COTTLE**  
46.0530.22  
22.0cm

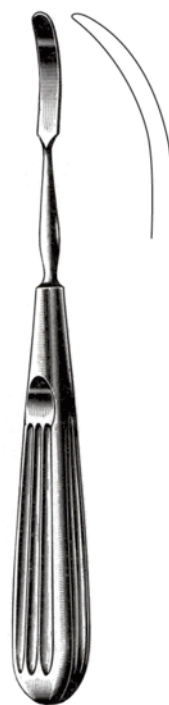

**JOSEPH**  
46.0534.16  
16.0cm



**COTTLE**  
46.0540.19  
19.0cm



**JOSEPH-MASING**  
46.0544.22  
22.0cm



**KILLIAN**  
46.0550.17 17.0cm



**KILLIAN-CLAUS**  
46.0554.17 17.0cm

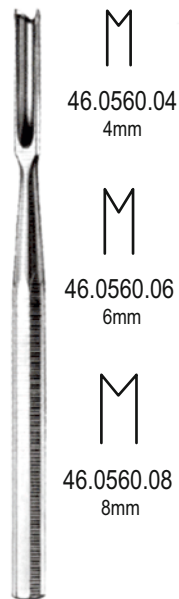

**BALLENGER**



**FREER**  
46.0564.15  
15.0cm



**WEST**  
46.0570.16 16.0cm



**WEST**  
46.0572.16 16.0cm



**FREER**  
46.0580.16



**FREER**  
46.0582.16

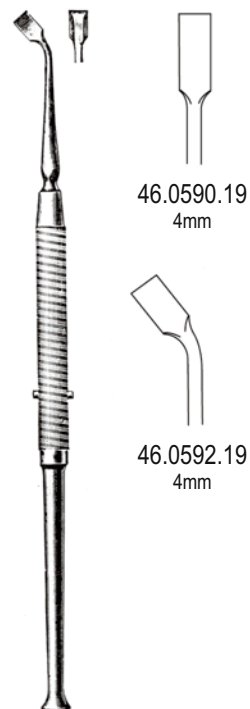

**FREER**





46.0600.17

46.0602.17

**JOSEPH**  
17.0cm

**JOSEPH**  
19.0cm

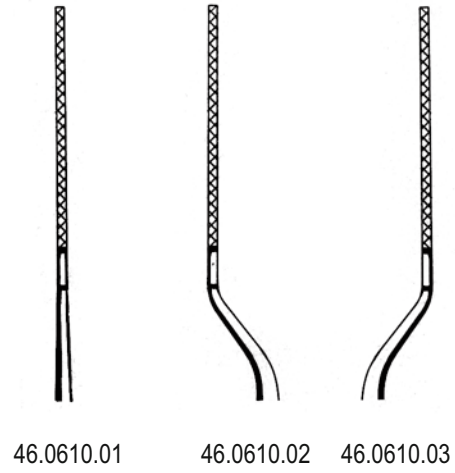

46.0610.01

46.0610.02

46.0610.03

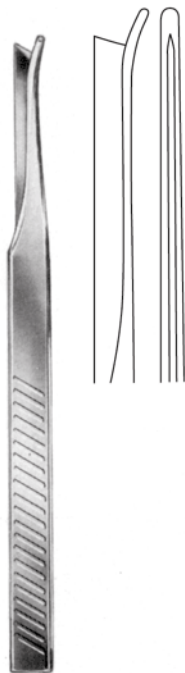

**SILVER**  
46.0614.01 18.0cm

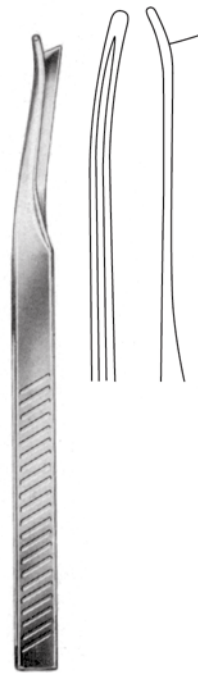

**SILVER**  
46.0614.02 18.0cm

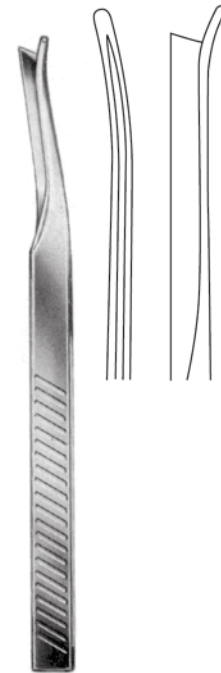

**SILVER**  
46.0614.03 18.0cm



6mm

**COTTLE**

46.0621.18 18.0cm

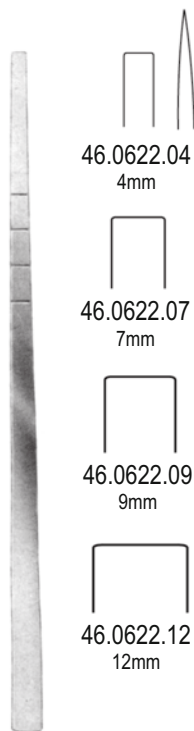

46.0622.04  
4mm

46.0622.07  
7mm

46.0622.09  
9mm

46.0622.12  
12mm

**COTTLE**

18.0cm



16mm

**COTTLE**

46.0624.18 18.0cm

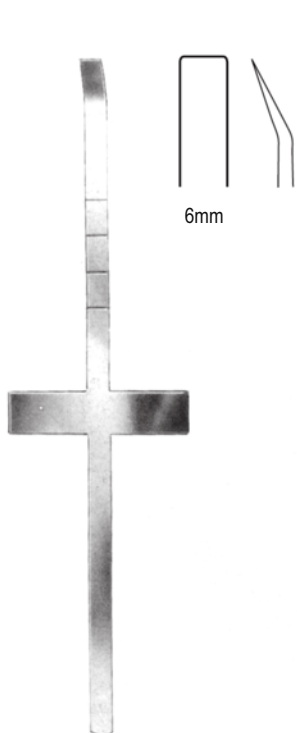

6mm

**COTTLE**

46.0623.18 18.0cm

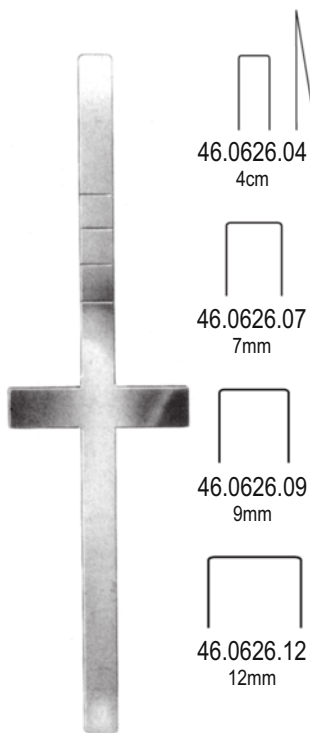

46.0626.04  
4cm

46.0626.07  
7mm

46.0626.09  
9mm

46.0626.12  
12mm

**COTTLE**

18.0cm



16mm

**COTTLE**

46.0628.18 18.0cm

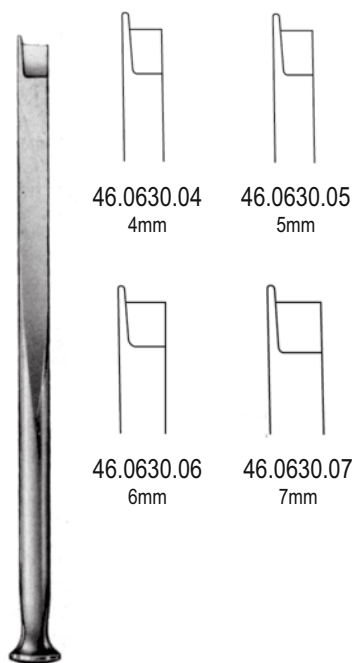

46.0630.04  
4mm

46.0630.05  
5mm

46.0630.06  
6mm

46.0630.07  
7mm

**FOMON**  
17.0cm

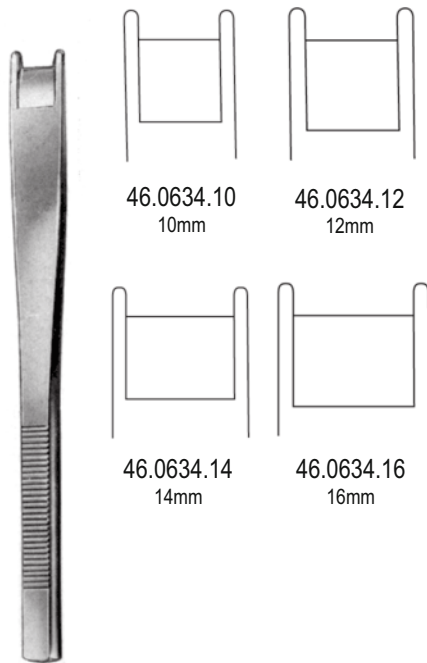

46.0634.10  
10mm

46.0634.12  
12mm

46.0634.14  
14mm

46.0634.16  
16mm

**CINELLI**  
16.0cm

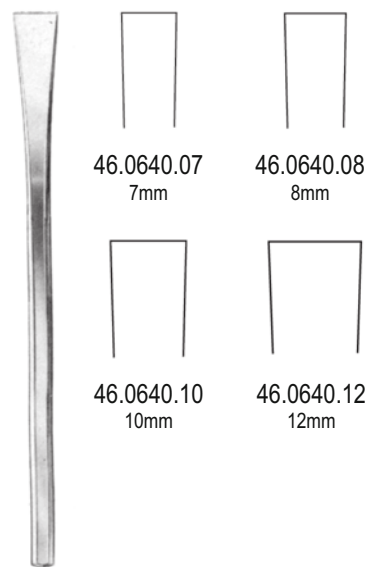

46.0640.07  
7mm

46.0640.08  
8mm

46.0640.10  
10mm

46.0640.12  
12mm

**SHEEHAN**  
17.0cm

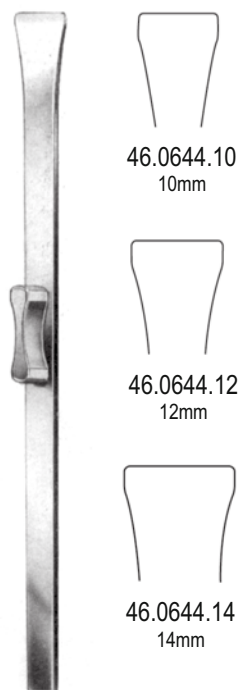

46.0644.10  
10mm

46.0644.12  
12mm

46.0644.14  
14mm

**RUBIN**  
18.0cm



46.0650.03  
3mm

46.0650.04  
4.5mm

**WALTER**  
19.0cm

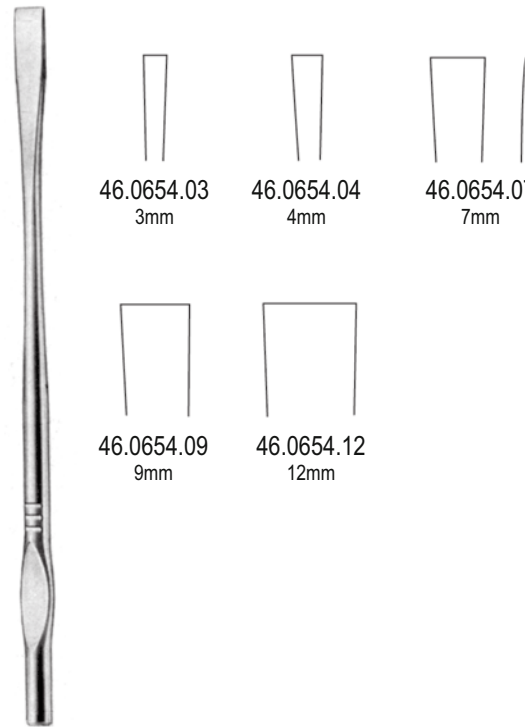

46.0654.03  
3mm

46.0654.04  
4mm

46.0654.07  
7mm

46.0654.09  
9mm

46.0654.12  
12mm

**WALTER**  
19.0cm

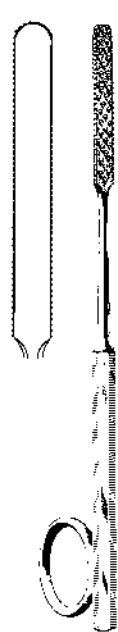

**GALLAHER**  
16.0cm



46.0660.01



46.0660.02

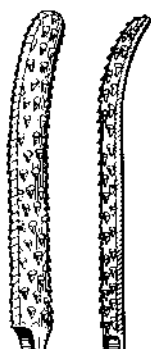

46.0660.03

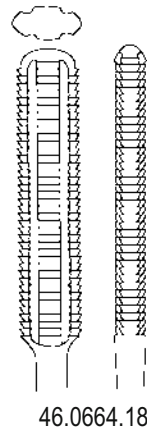

46.0664.18



**MALTZ**  
18.0cm



**JOSEPH**  
16.0cm

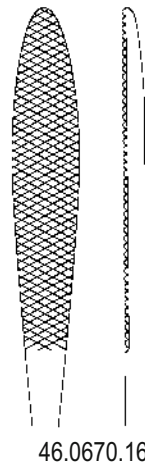

46.0670.16

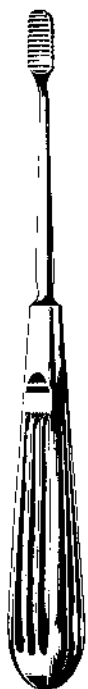

**LEWIS**  
18.0cm

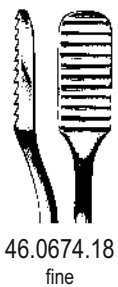

46.0674.18  
fine

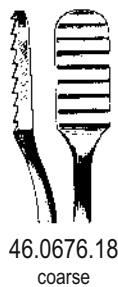

46.0676.18  
coarse



**AUFRICHT**  
21.0cm

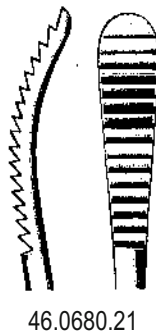

46.0680.21

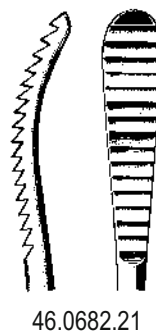

46.0682.21



**COTTLE**  
21.0cm

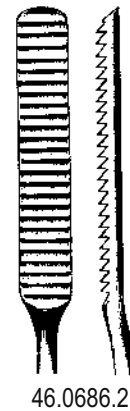

46.0686.21



**WIENER**  
18.0cm



46.0690.18



46.0692.18

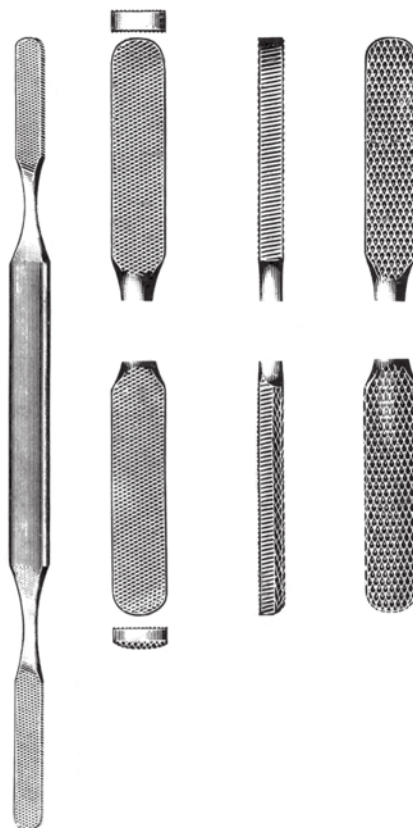

**FOMON**  
46.0696.21 21.0cm

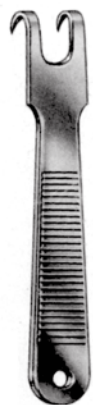

**KILNER**  
46.0700.10 10.0cm



**CONVERSE**  
46.0704.12 12.0cm



**AUFRICHT**  
46.0710.16 16.0cm

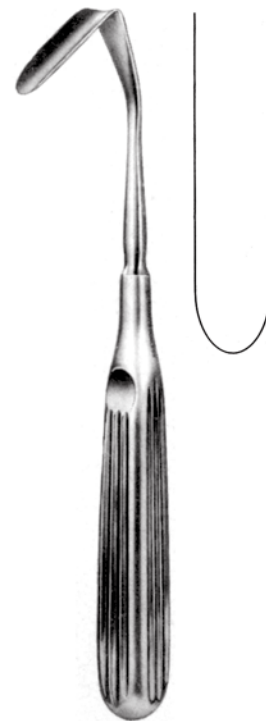

**AUFRICHT**  
46.0712.19 19.0cm



15.0cm



46.0716.01



46.0716.02



46.0716.03



**LANGE**  
46.0720.22 22.0cm



**FOMON**  
46.0724.17 17.0cm



**COTTLE**  
46.0730.16 16.0cm



**FREER**  
46.0740.15 15.0cm







**OGURA**  
46.0744.11 11.0cm



**COTTLE**  
46.0750.11 11.0cm



**COTTLE**  
46.0754.14 14.0cm



**COTTLE**  
15.0cm



46.0760.14



46.0762.01



46.0762.02



**FOMON**  
46.0766.16 16.0cm

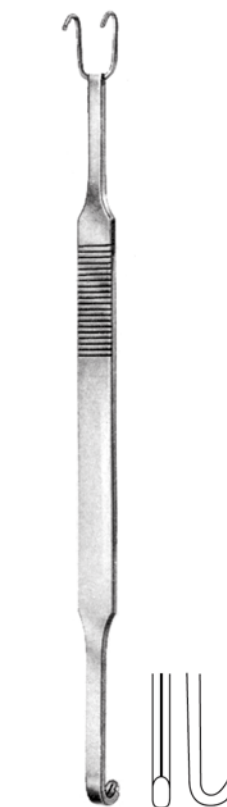

**COTTLE-NEIVERT**  
46.0770.20 20.0cm



**YANKAUER**  
17.0cm



46.0774.01 46.0774.02 46.0774.03 46.0774.04 46.0774.05



46.0774.06 46.0774.07 46.0774.08 46.0774.09



**COTTLE**  
46.0780.14 14.0cm



**NEIVERT**  
46.0784.16 16.0cm



**COTTLE**  
46.0800.15 15.0cm



**COTTLE**  
46.0802.15 15.0cm



**AUFRICHT**  
46.0806.13 13.5cm

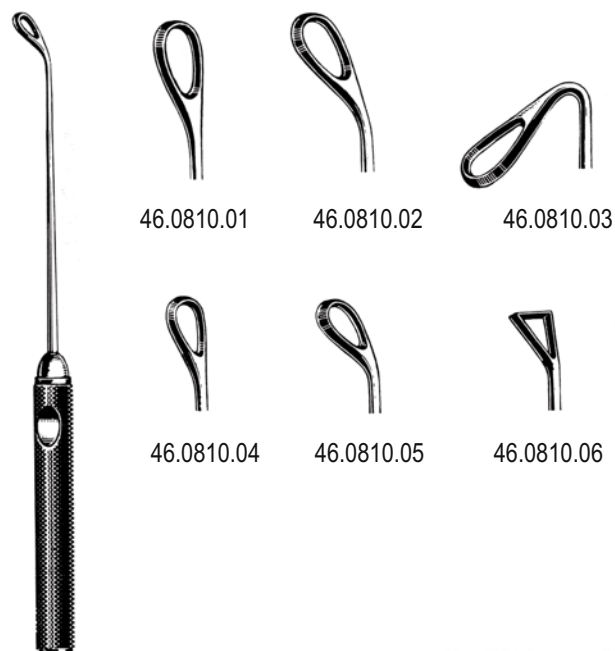

**COAKLEY**  
17.0cm

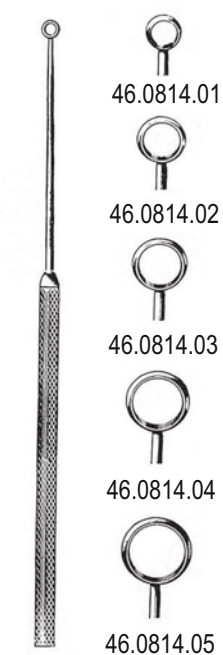

**MYLES**  
17.0cm

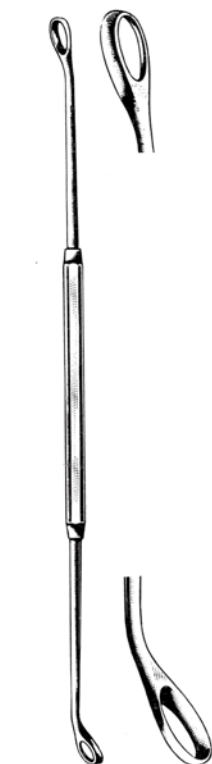

46.0820.20 20.0cm



**PRATT**  
46.0824.21 21.0cm

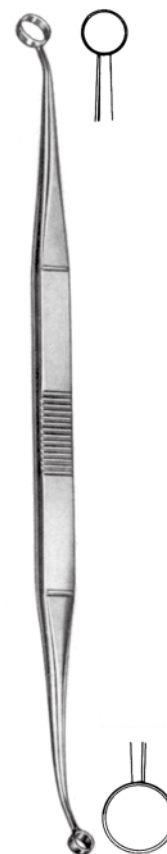

**FAULKNER**  
46.0826.21 21.0cm



**KRESSNER**  
46.0830.20 20.0cm



**ASCH**  
46.0834.23 23.0cm



46.0840.23  
straight



46.0842.23  
left



46.0844.23  
right



**COTTLE-WALSHAM**  
23.0cm



**BECKMANN** 22.0cm  
46.0850.01 - 46.0850.06



**BECKMANN** 22.0cm  
46.0852.01 - 46.0852.06



46.0850.01  
46.0852.01



46.0850.02  
46.0852.02



46.0850.03  
46.0852.03



46.0850.04  
46.0852.04



46.0850.05  
46.0852.05



46.0850.06  
46.0852.06



**BECKMANN**  
22.0cm

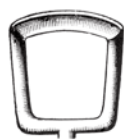

46.0856.01

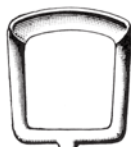

46.0856.02

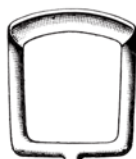

46.0856.03

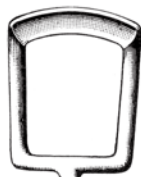

46.0856.04

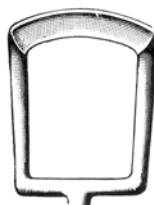

46.0856.05



**ST.CLAIR-THOMSON**  
21.0cm



46.0860.08  
8mm



46.0860.10  
10mm



46.0860.12  
12mm



46.0860.14  
14mm



46.0860.16  
16mm



46.0860.18  
18mm



**BRUENINGS-BRUNK**  
46.0864.21 21.5cm



**LA FORCE**  
25.0cm

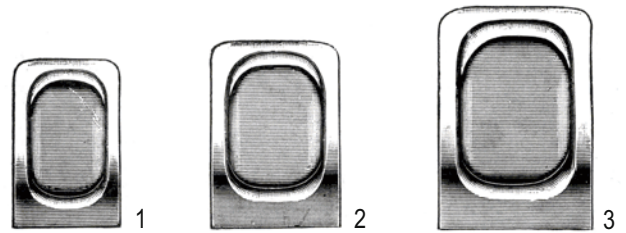

with unperforated blade  
46.0870.01 Fig. 1  
46.0870.02 Fig. 2  
46.0870.03 Fig. 3

spare blades  
46.0874.01 Fig. 1  
46.0874.02 Fig. 2  
46.0874.03 Fig. 3

with perforated blade  
46.0872.01  
46.0872.02  
46.0872.03

46.0876.01  
46.0876.02  
46.0876.03

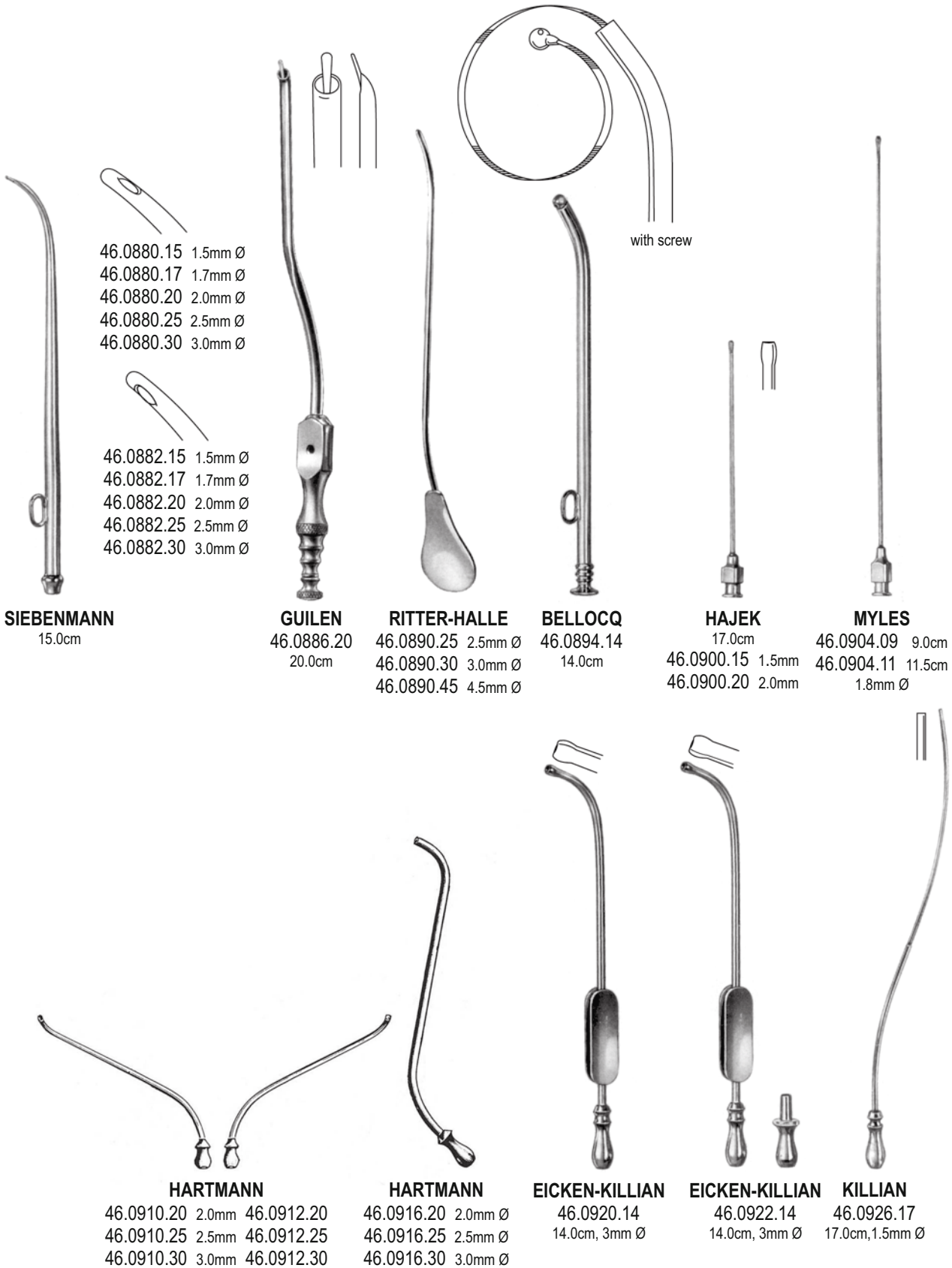

46.0880.15 1.5mm Ø  
46.0880.17 1.7mm Ø  
46.0880.20 2.0mm Ø  
46.0880.25 2.5mm Ø  
46.0880.30 3.0mm Ø

46.0882.15 1.5mm Ø  
46.0882.17 1.7mm Ø  
46.0882.20 2.0mm Ø  
46.0882.25 2.5mm Ø  
46.0882.30 3.0mm Ø

**SIEBENMANN**  
15.0cm

**GUILLEN**  
46.0886.20 20.0cm

**RITTER-HALLE**  
46.0890.25 2.5mm Ø  
46.0890.30 3.0mm Ø  
46.0890.45 4.5mm Ø

**BELLOCQ**  
46.0894.14 14.0cm

**HAJEK**  
17.0cm  
46.0900.15 1.5mm  
46.0900.20 2.0mm

**MYLES**  
46.0904.09 9.0cm  
46.0904.11 11.5cm  
1.8mm Ø

**HARTMANN**  
46.0910.20 2.0mm  
46.0910.25 2.5mm  
46.0910.30 3.0mm  
46.0912.20  
46.0912.25  
46.0912.30

**HARTMANN**  
46.0916.20 2.0mm Ø  
46.0916.25 2.5mm Ø  
46.0916.30 3.0mm Ø

**EICKEN-KILLIAN**  
46.0920.14 14.0cm, 3mm Ø

**EICKEN-KILLIAN**  
46.0922.14 14.0cm, 3mm Ø

**KILLIAN**  
46.0926.17 17.0cm, 1.5mm Ø