

# 48

Страницы раздела  
001-011

## ИНСТРУМЕНТЫ ДЛЯ ПОЛОСТИ РТА

ORAL INSTRUMENTS

Перейти в **СОДЕРЖАНИЕ**

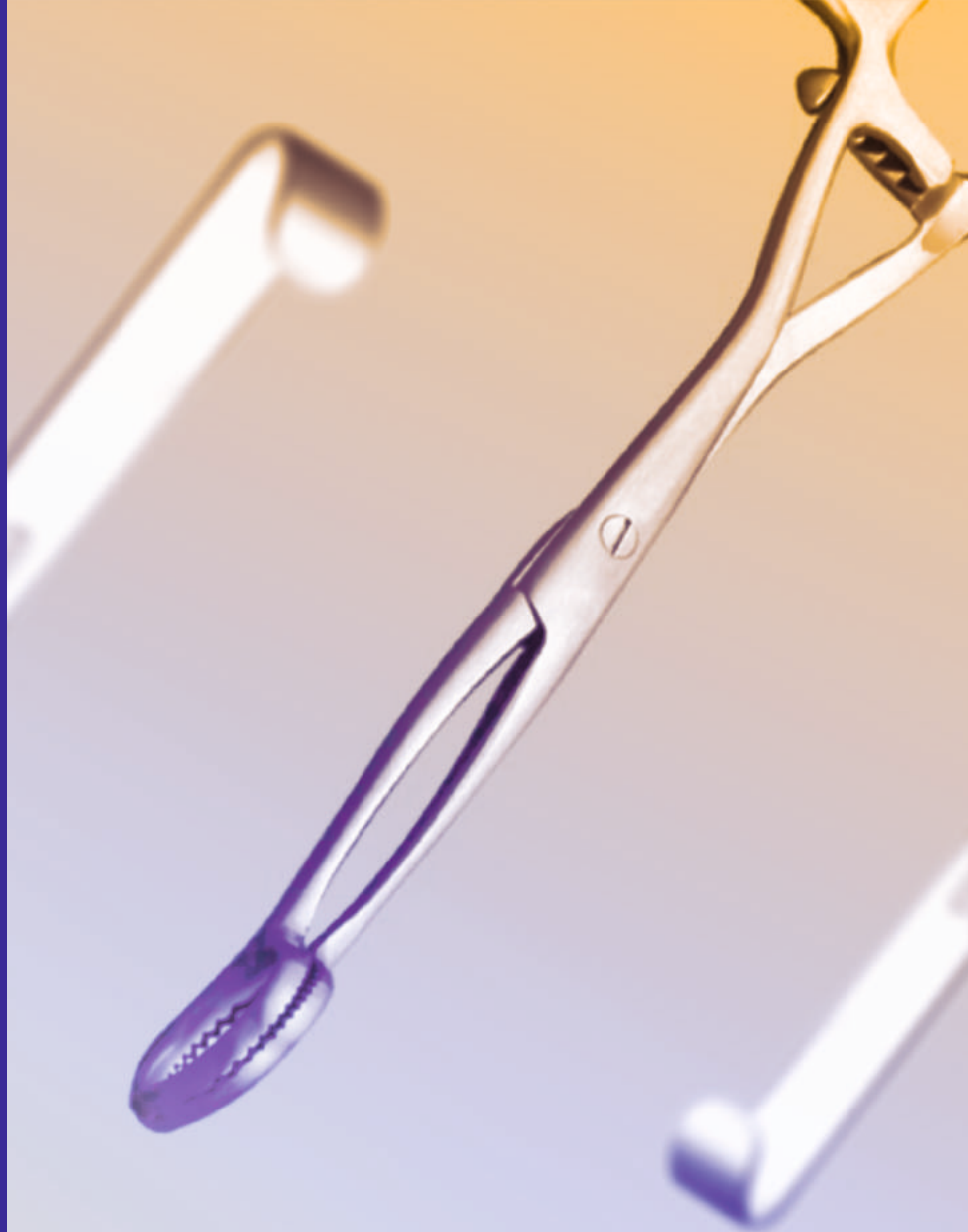



**PITHA**  
48.0010.02



48.0012.00  
length adjustable



**ADAMS**  
48.0014.00

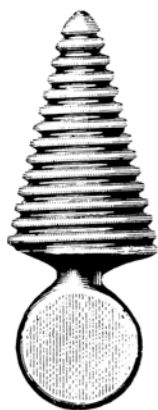

**MAUNDER**  
48.0020.10



48.0030.11



**PITHA**  
48.0036.10



48.0040.01



**LANGENBECK**  
48.0040.02

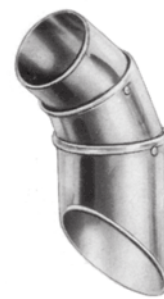

48.0040.03



**DENHART**  
48.0050.12 12.0cm



**DENHART**  
48.0054.12 12.5cm

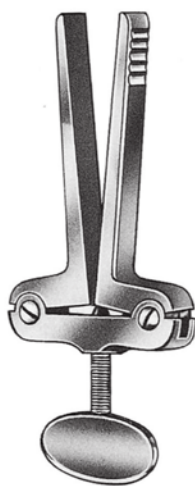

**HEISTER**  
48.0060.13 13.0cm

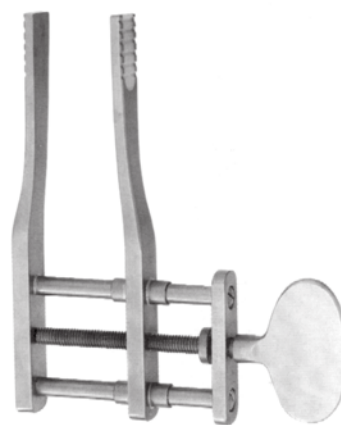

**OBWEGESER**  
48.0064.12 12.5cm

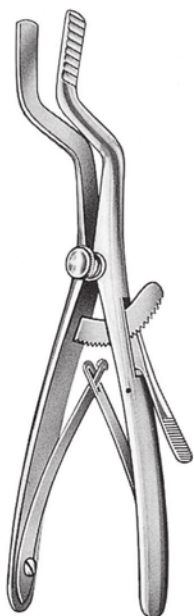

**ROSER-KÖNIG**  
48.0070.16 16.0cm  
48.0070.19 19.0cm

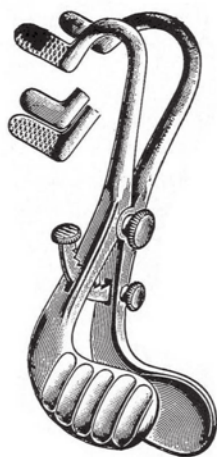

**BUXTON**  
ackland jaws parallel jaws  
48.0080.01 48.0080.02

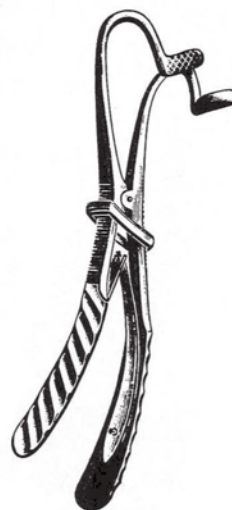

**FERGUSSON**  
ackland jaws parallel jaws  
48.0090.16 16.0cm 48.0092.16  
48.0090.19 19.0cm 48.0092.19

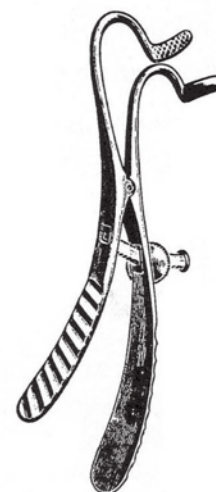

**MASON**  
ackland jaws parallel jaws  
48.0100.15 15.0cm 48.0102.15  
48.0100.19 19.0cm 48.0102.19



**MOLT**  
48.0110.11 11.0cm

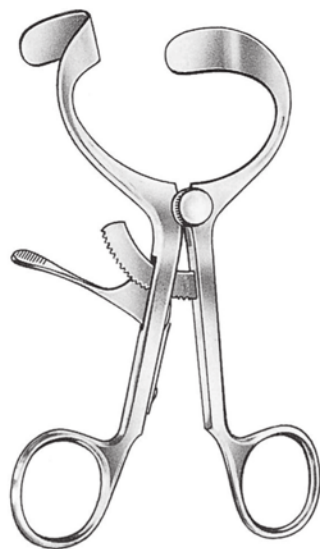

**MOLT**  
48.0112.14 14.0cm



**MALEK**  
13.0cm

- 48.0120.00 compl. set
- 48.0120.13 frame only
- 48.0120.01 blade, fig.1, 15-19 x 36mm
- 48.0120.02 blade, fig.2, 17-21 x 44mm
- 48.0120.03 blade, fig.3, 19-23 x 59 mm
- 48.0120.04 blade, fig.4, 25-31 x 78 mm

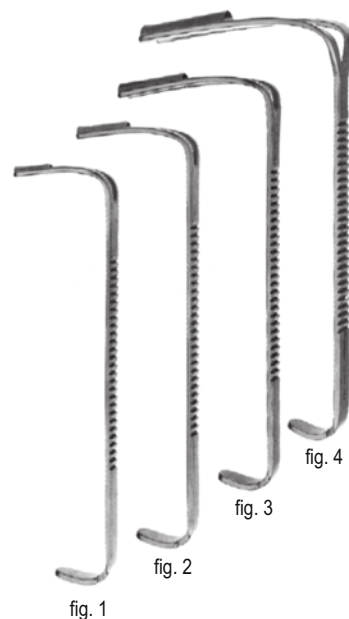

**KILNER-DOUGHTY**  
48.0124.00 compl. set  
48.0124.10 frame only



48.0124.01



48.0124.02



48.0124.03



48.0124.04

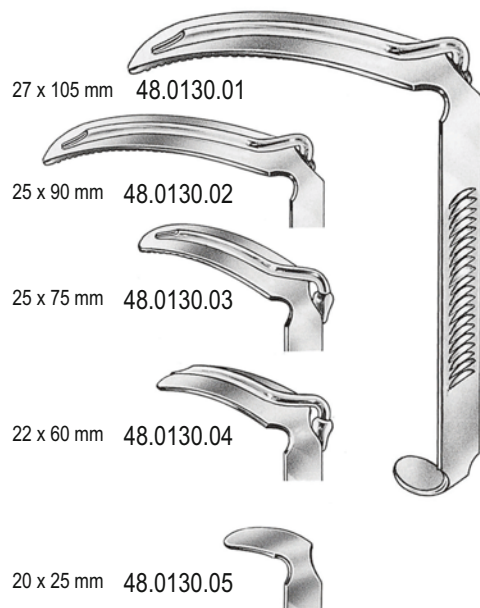

**DAVIS-BOYLE**

**Adult:** 48.0130.00 compl. set  
48.0130.10 frame only

**Child:** 48.0132.00 compl. set  
48.0132.10 frame only

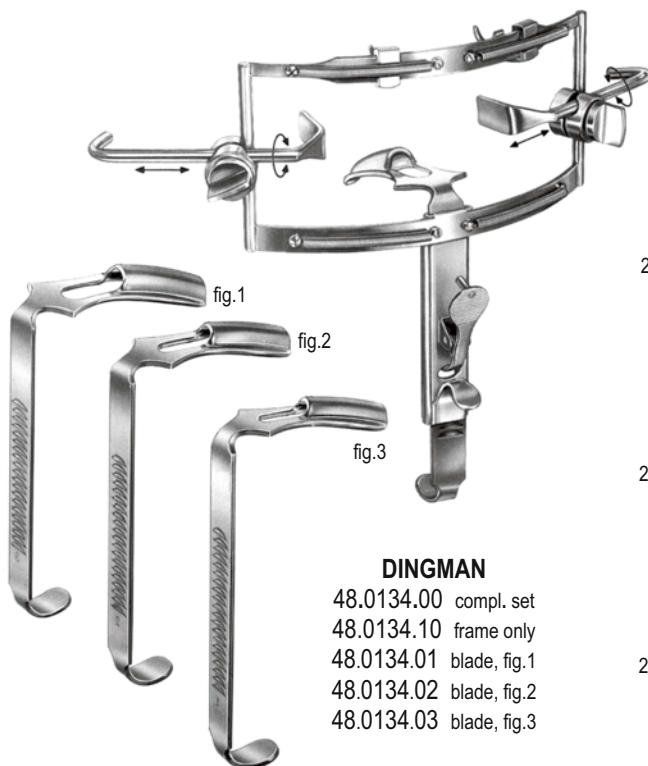

**DINGMAN**

48.0134.00 compl. set  
48.0134.10 frame only  
48.0134.01 blade, fig.1  
48.0134.02 blade, fig.2  
48.0134.03 blade, fig.3

27 x 95 mm 48.0140.01

22 x 85 mm 48.0140.02

22 x 70 mm 48.0140.03

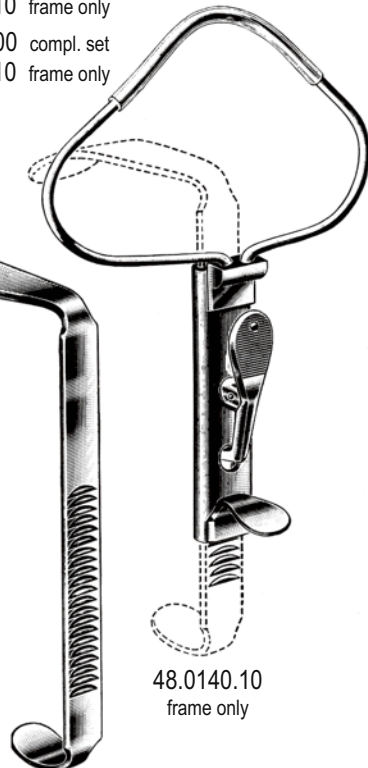

**McIVOR**

48.0140.00 compl. set





**ORINGER**  
48.0144.10 - 48.0144.03

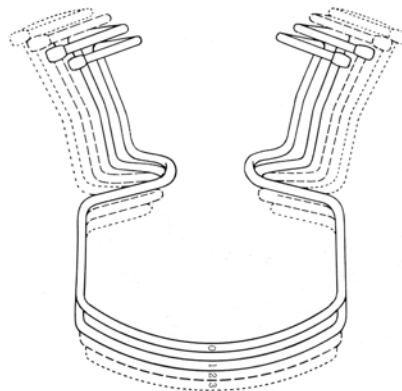

48.0144.00 set  
48.0144.10 fig.0  
48.0144.01 fig.1  
48.0144.02 fig.2  
48.0144.03 fig.3

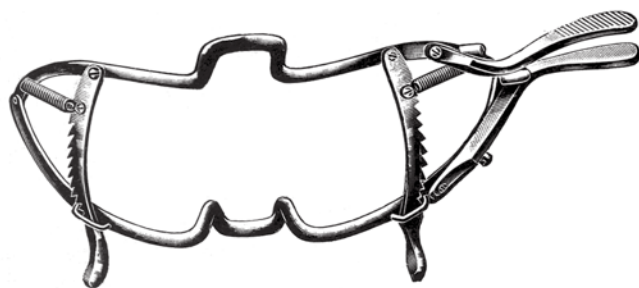

**WHITEHEAD**  
48.0150.11 11.0cm  
48.0150.13 13.0cm  
48.0150.15 15.0cm

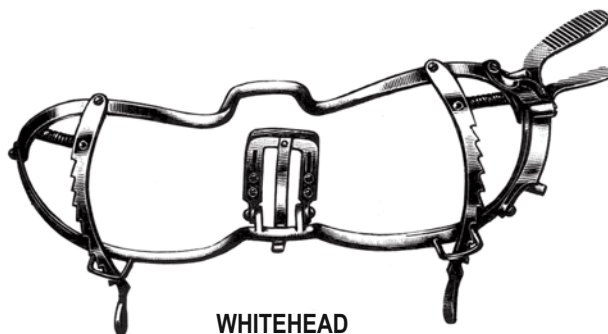

**WHITEHEAD**  
48.0154.11 11.0cm  
48.0154.13 13.0cm  
48.0154.15 15.0cm

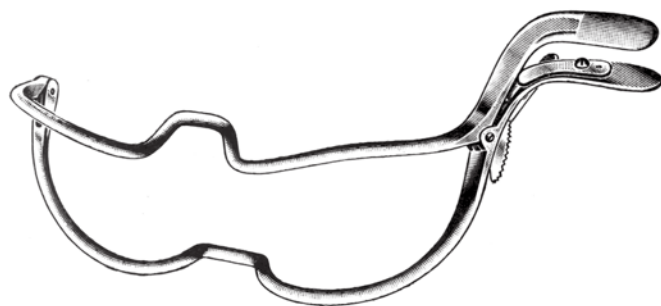

**JENNINGS**  
48.0160.09 9.0cm  
48.0160.11 11.0cm  
48.0160.13 13.0cm  
48.0160.15 15.0cm



**SEEMANN-SEIFFERT (self-retaining)**  
48.0164.09 9.0cm  
48.0164.11 11.0cm  
48.0164.13 13.0cm  
48.0164.15 15.0cm



**SIMPLEX**  
48.0170.11 11.0cm



**BISHOP**  
48.0174.13 13.0cm



**CAWOOD**  
48.0180.15 15.5cm



48.0184.14 14.0cm



48.0186.18 18.5cm

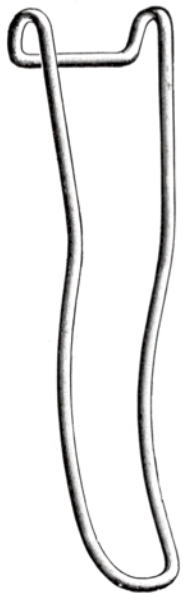

**STERNBERG**  
48.0190.14 14.0cm  
48.0190.16 16.0cm  
48.0190.18 18.0cm



**STERNBERG**  
48.0192.12 12.0cm  
48.0192.14 14.0cm  
48.0192.16 16.0cm



48.0200.19 19.0cm



48.0200.21 21.0cm



**ORIGINAL TESSIER**  
20.5cm  
48.0204.01 for children  
48.0204.02 for adults



**LACK**  
12.0cm  
48.0210.13 13mm  
48.0210.19 19mm  
48.0210.22 22mm



**HARTMANN**  
48.0214.15 15.0cm

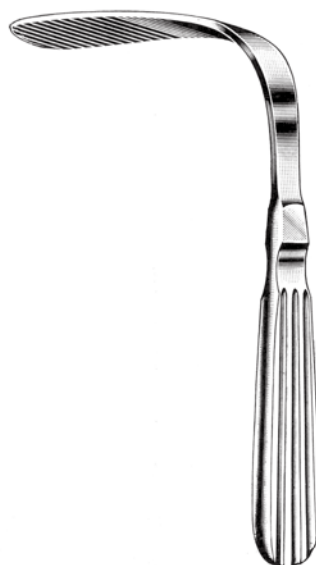

**TOBOLD**  
48.0220.14 14.5cm

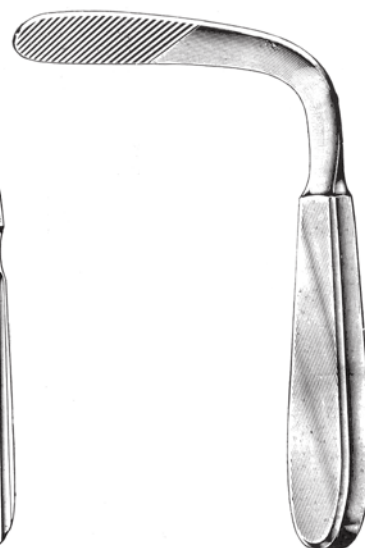

**TOBOLD**  
48.0222.14 14.5cm



**ANDREW**  
48.0226.11 11.0cm



**WIEDER**  
48.0230.03 16.5cm

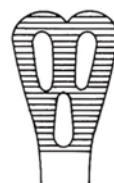

48.0230.01  
14.0cm

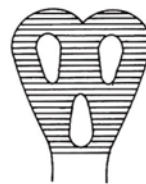

48.0230.02  
15.0cm



**WIEDER (modif)**  
48.0232.14 14.5cm  
with fibre optic cable fitting





**DOYEN**  
48.0236.13 13.0cm  
48.0236.16 16.0cm



**KROENIG**  
48.0240.15  
15.0cm



**MAYO**  
48.0244.17  
17.0cm



**BRUENINGS**  
48.0250.19  
19.0cm



**COLLIN**  
48.0254.16  
16.5cm



48.0260.16  
16.5cm

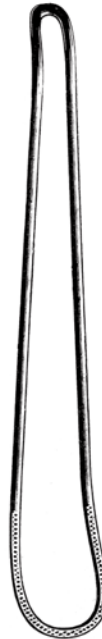

**FRENZEL**  
48.0262.16  
16.5cm

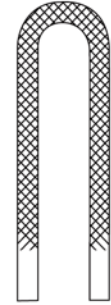

48.0266.16  
16.0cm  
of wood



48.0270.15  
15.0cm  
of plastic



**HAAS**  
48.0274.16  
16.0cm  
of acrylic glass



**BUCHWALD**  
48.0280.17  
17.0cm



48.0284.18  
18.5cm  
nylon boilable



48.0290.14  
14.5cm

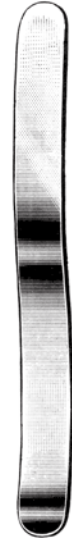

48.0294.14  
14.5cm

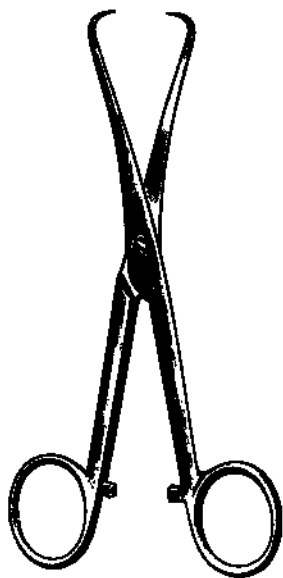

**LOEBKER**  
48.0300.15 15.5cm

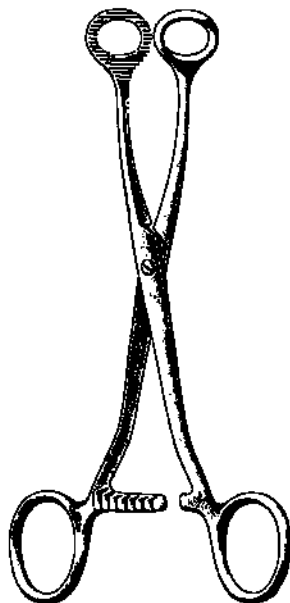

**COLLIN**  
48.0304.16 16.0cm

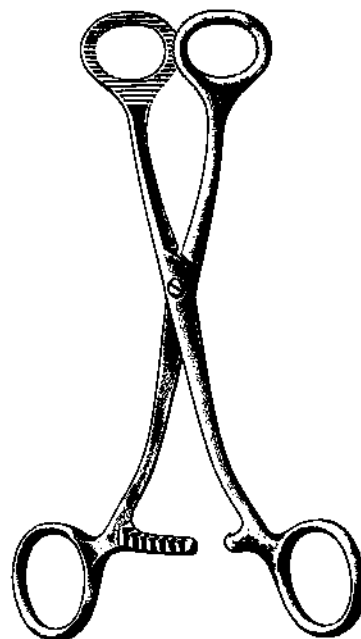

**COLLIN**  
48.0306.17 17.0cm  
48.0306.19 19.0cm

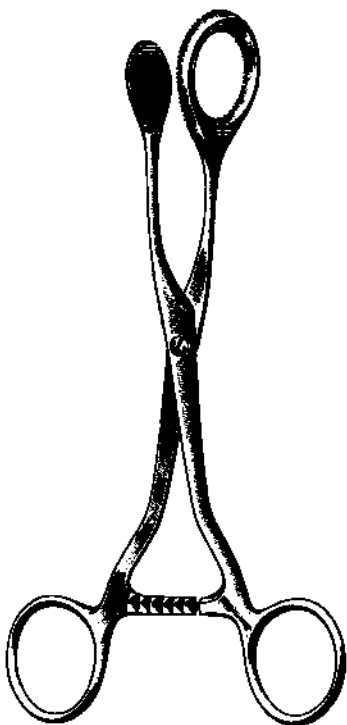

**MATHIEU**  
48.0310.19 19.0cm

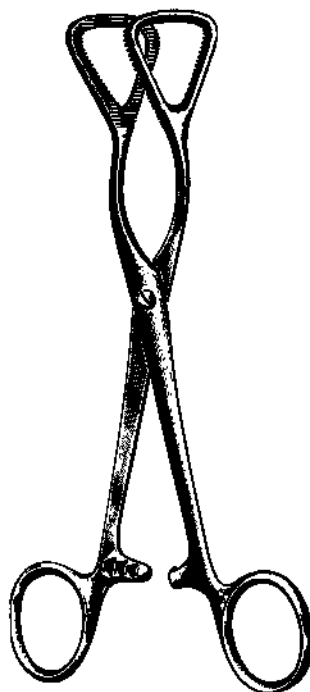

**GUY**  
48.0314.19 19.0cm

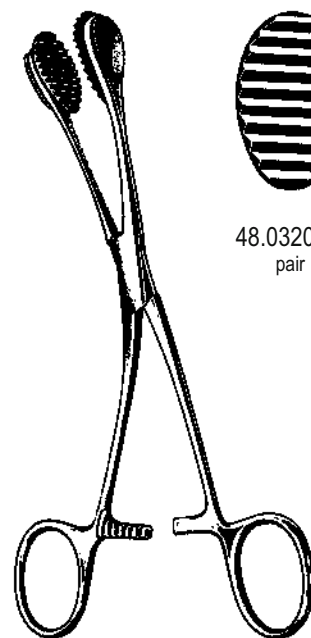

**YOUNG**  
48.0320.17 17.0cm



48.0320.02  
pair



**DUMBACH**  
48.0400.01 15.0cm  
for blades, size 11 and 12



**DUMBACH**  
48.0400.02 15.0cm  
for blades, size 11,12 and 15



**DUMBACH**  
48.0400.03 15.0cm  
for blades, size 11,12 and 15



48.0404.15 15.0cm  
for blades, size 9-17, 40 and 42



48.0410.14 14.5cm  
No.3, straight



48.0411.14 14.5cm  
No.3, angled



48.0412.16 16.0cm  
No.4 straight



48.0413.16 16.0cm  
No.4, angled



**CAPLAN**  
48.0420.21 21.5cm



**CAPLAN**  
48.0422.21 21.0cm