

50

Страницы раздела
001-015

ИНСТРУМЕНТЫ ДЛЯ МИНДАЛИН

TONSIL

Перейти в **СОДЕРЖАНИЕ**





HURD

50.0010.21 21.0cm 50.0012.21



DURHAM

50.0020.25 25.0cm 50.0022.25



ROTTER

50.0030.26 26.0cm 50.0032.26





NAGER
50.0040.24 24.0cm

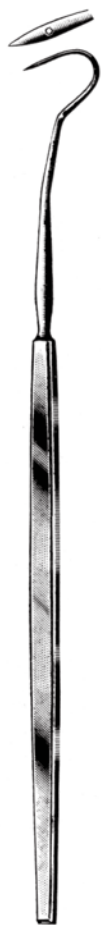

CLAUS-EICKEN
50.0046.23 23.0cm



DUPUY-WEISS
50.0050.22 22.0cm 50.0052.22



FALK
50.0060.24 24.0cm 50.0062.24





BRUENINGS
50.0070.23 23.0cm



ABRAHAM
50.0074.21 21.0cm



FISHER
50.0080.22 22.5cm



COLVER
50.0084.22 22.5cm

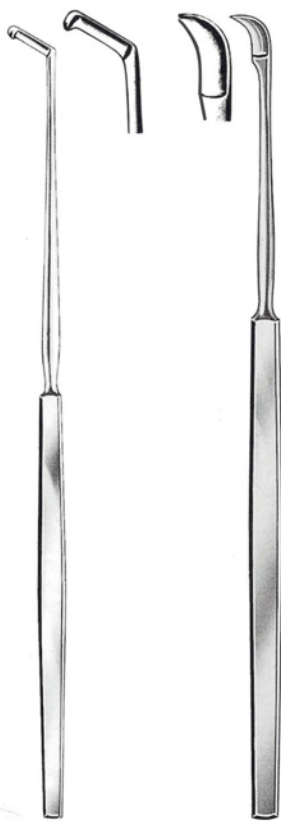

DOUGLAS
50.0090.21 21.0cm

CANFIELD
50.0094.21 21.0cm



TYDING
50.0100.21 21.0cm



LYNCH
50.0104.20 20.0cm



DAY
50.0110.21 21.5cm



LUNIATSCHEK
50.0114.19 19.0cm



HURD
50.0120.22 22.5cm

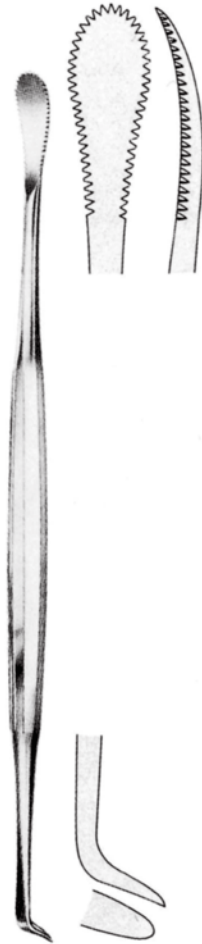

HENKE
50.0124.23 23.0cm

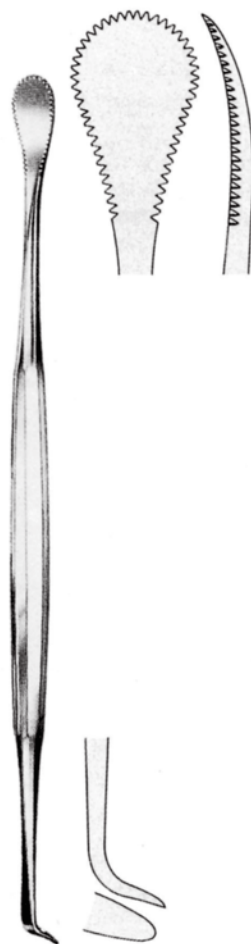

HENKE
50.0130.23 23.0cm

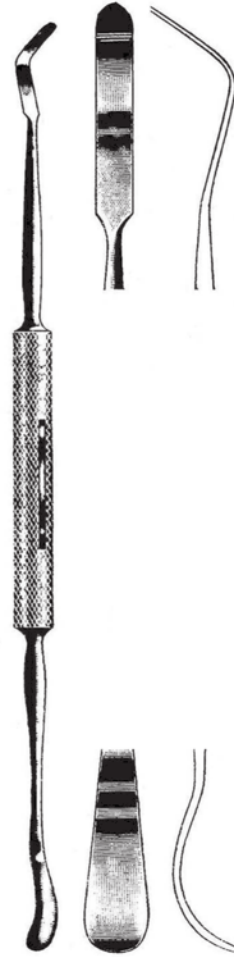

CARPENTER
50.0134.25 25.0cm

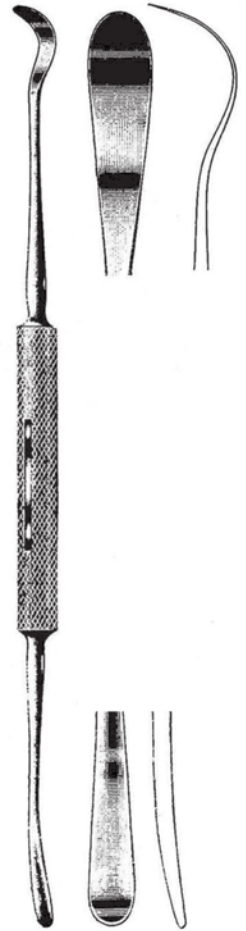

CARPENTER
50.0140.24 24.0cm

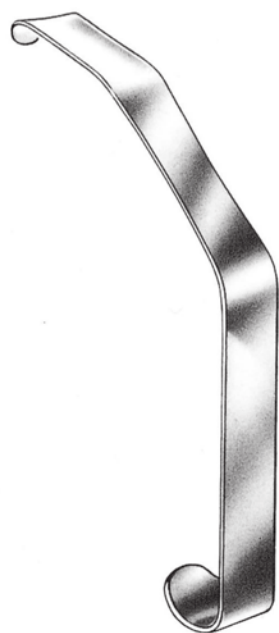

LOVE
15.0cm
50.0150.18 18mm
50.0150.20 20mm
50.0150.22 22mm



MARSCHIK
50.0154.22 22.0cm

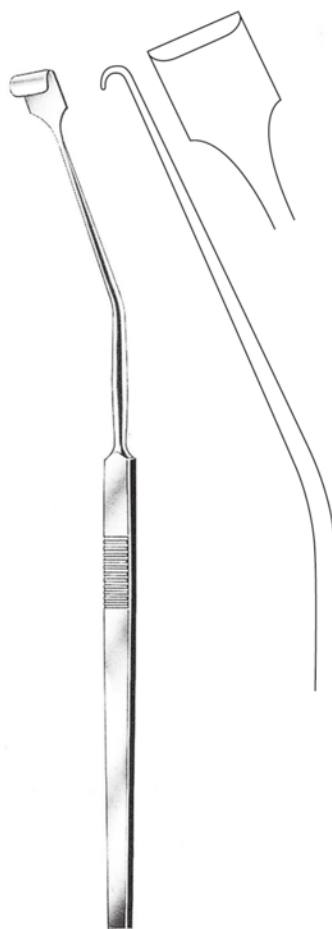

NAGER
50.0160.24 24.0cm



HOFER
50.0164.24 24.0cm

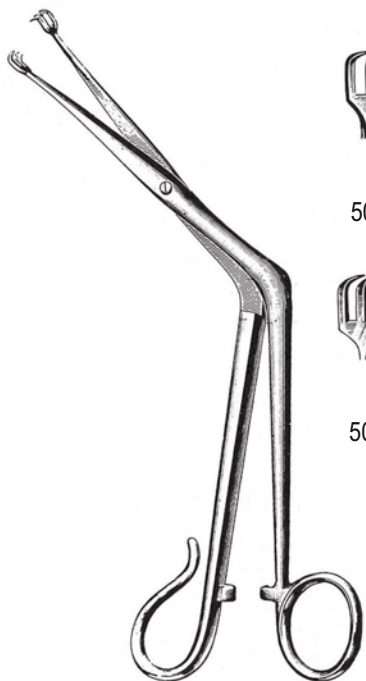

TIVNEN-TYDING
21.0cm



Fig. 1
50.0170.21



Fig. 2
50.0172.21

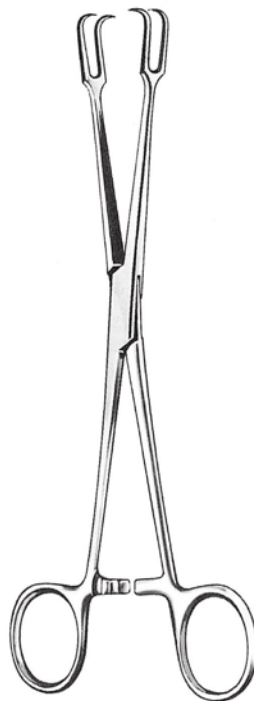

MUSEUX
50.0180.20 20.0cm

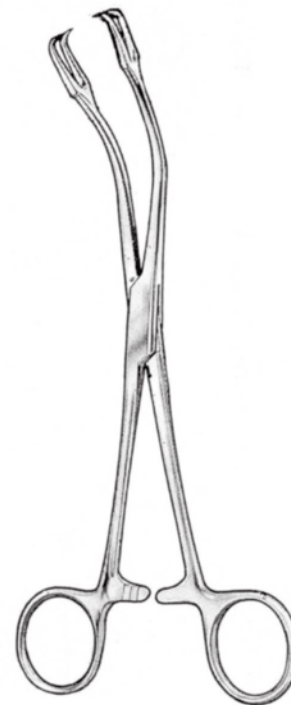

MUSEUX
50.0181.20 20.0cm

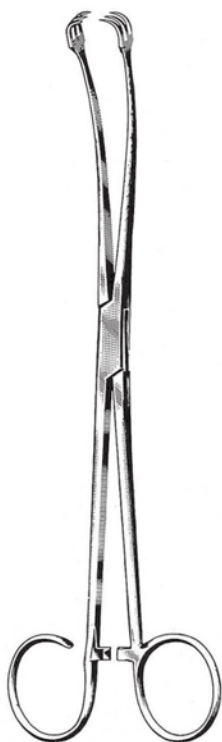

BALLENGER
50.0184.21 21.5cm



WHITE
50.0190.18 18.0cm
50.0190.23 23.0cm



50.0194.19



50.0195.19

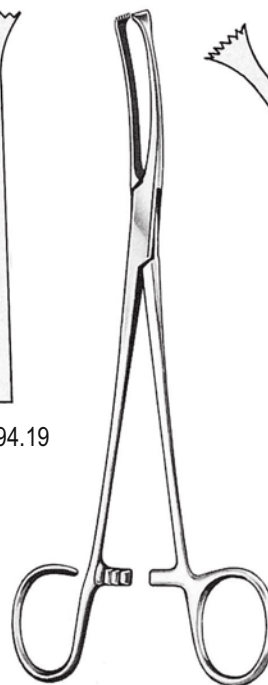

COLVER
19.0cm

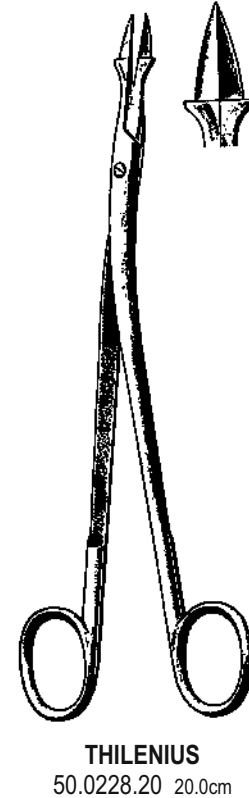
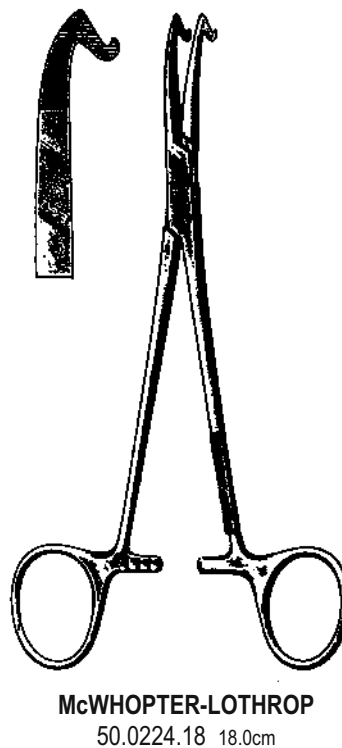
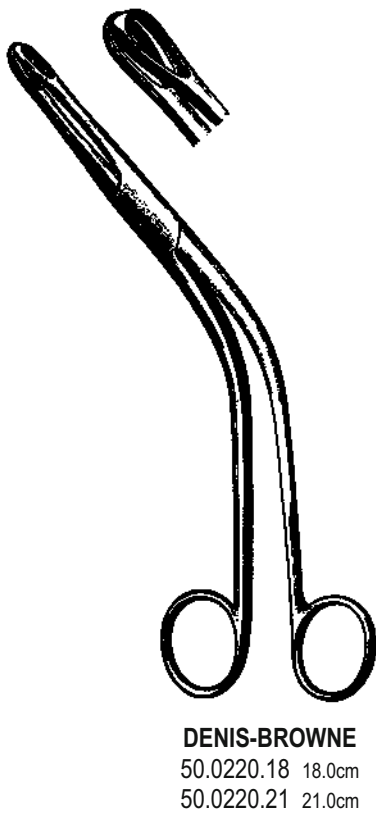
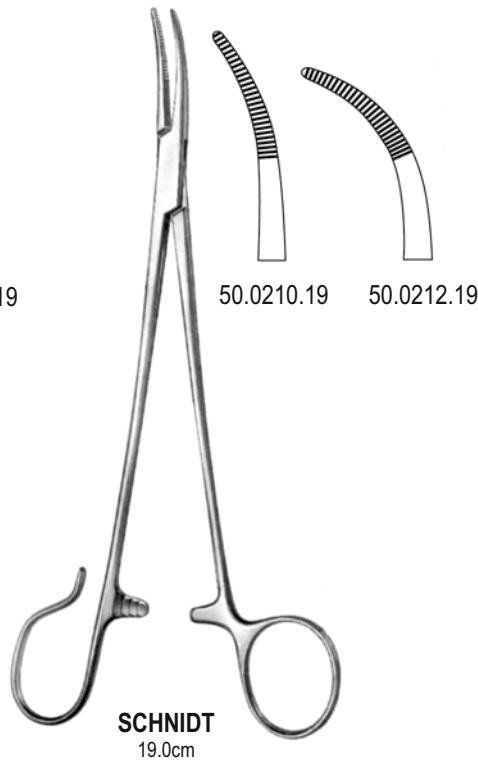
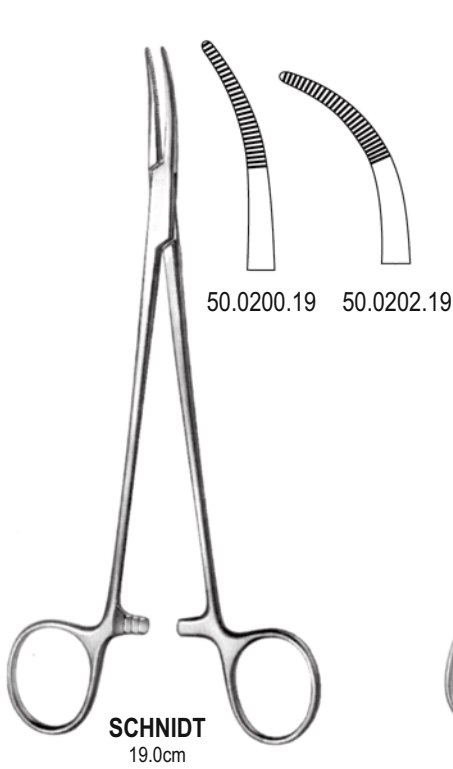



NEGUS
19.0cm

50.0230.19



50.0232.19

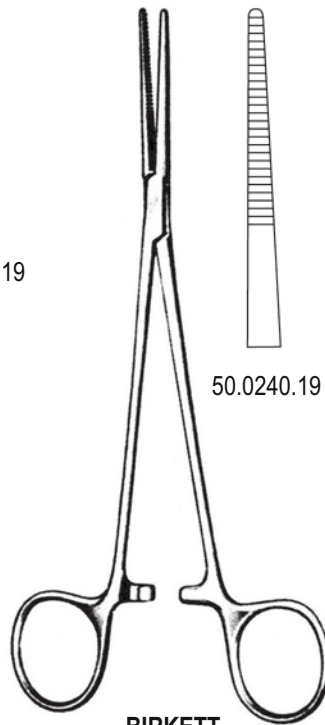

BIRKETT
19.0cm

50.0240.19



50.0241.19

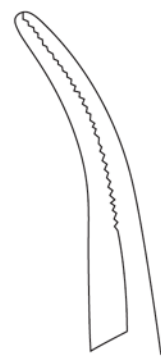

50.0243.19

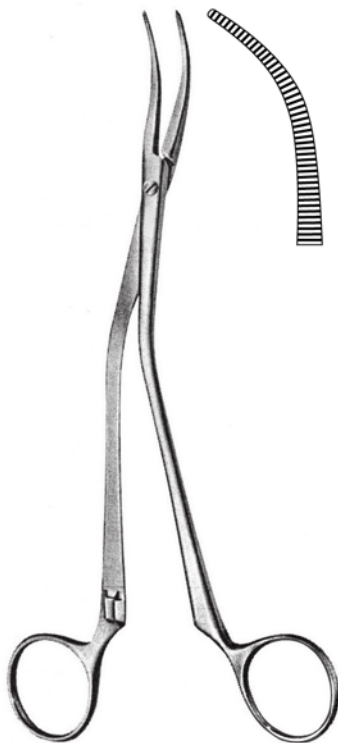

WILSON
50.0250.19 19.0cm

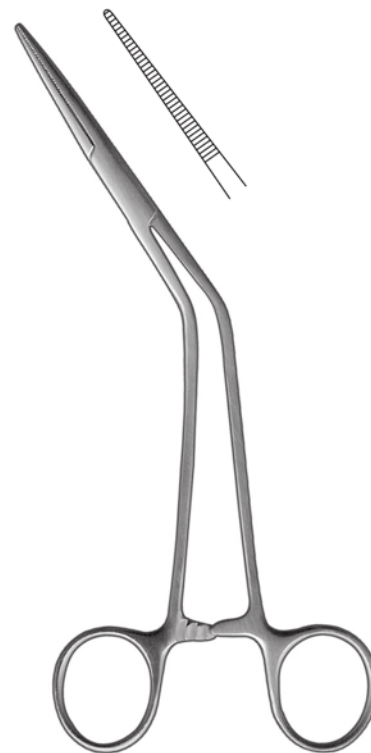

MOLLISON
50.0254.18 18.0cm (with horizontal opening)
50.0256.18 18.0cm (with vertical opening)



EVES
50.0260.28 28.0cm



EVES
50.0270.28 28.0cm



BRUENINGS
50.0280.28 28.0cm

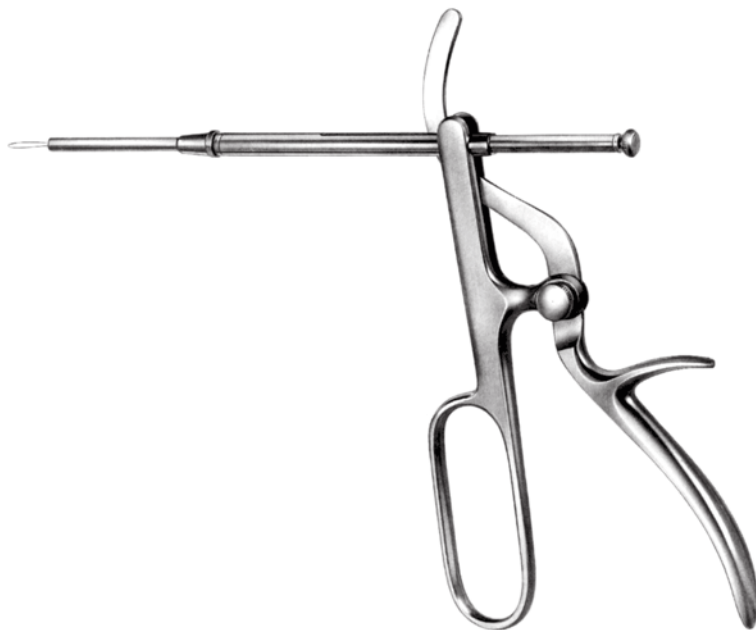

TYDING
50.0290.00

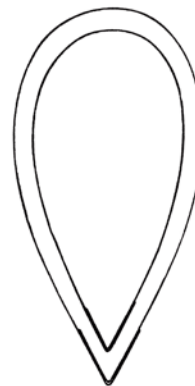

50.0300.40 40mm
50.0300.50 50mm



50.0306.03 0.3mm Ø

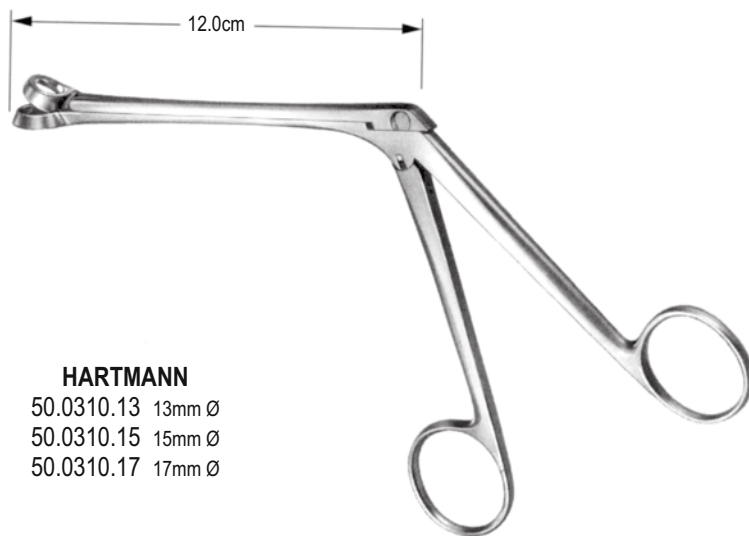

HARTMANN
50.0310.13 13mm Ø
50.0310.15 15mm Ø
50.0310.17 17mm Ø

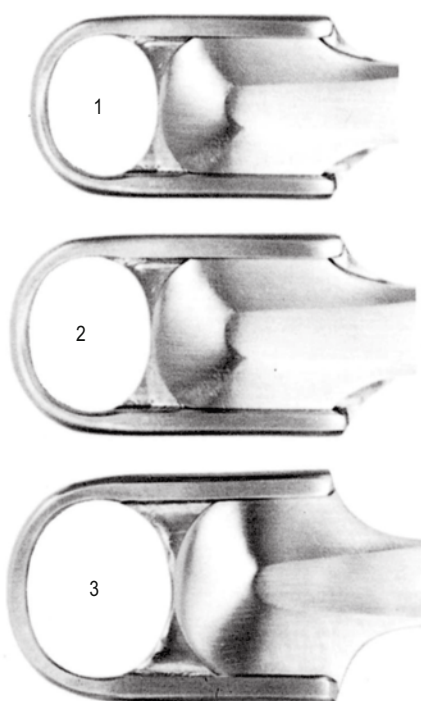

SLUDER-BALLENGER
50.0320.00 compl.
3-tips
50.0320.01
50.0320.02
50.0320.03

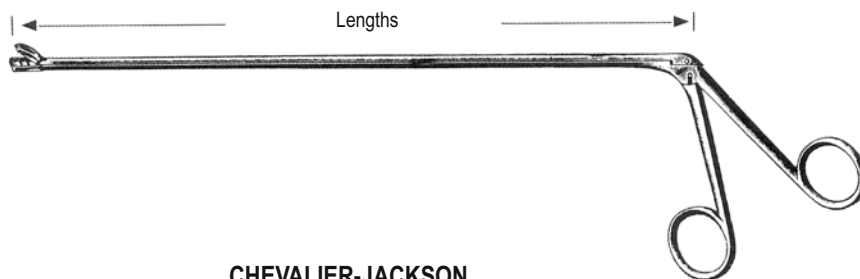

CHEVALIER-JACKSON



30.0cm	50.0331.30	50.0332.30	50.0333.30	50.0334.30	50.0335.30	50.0336.30	50.0337.30
40.0cm	50.0331.40	50.0332.40	50.0333.40	50.0334.40	50.0335.40	50.0336.40	50.0337.40
50.0cm	50.0331.50	50.0332.50	50.0333.50	50.0334.50	50.0335.50	50.0336.50	50.0337.50
60.0cm	50.0331.60	50.0332.60	50.0333.60	50.0334.60	50.0335.60	50.0336.60	50.0337.60



HUBER
50.0340.00



BRUENINGS (straight)

50.0344.20	20.0cm
50.0344.30	30.0cm
50.0344.40	40.0cm
50.0344.50	50.0cm
50.0344.60	60.0cm

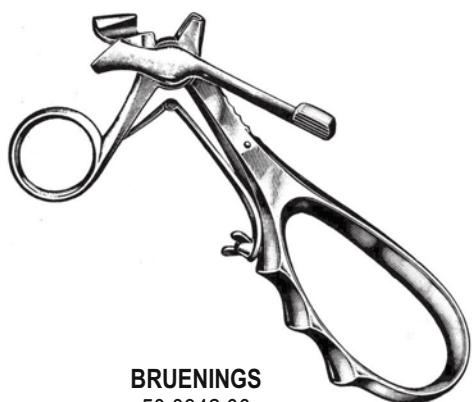

BRUENINGS
50.0342.00

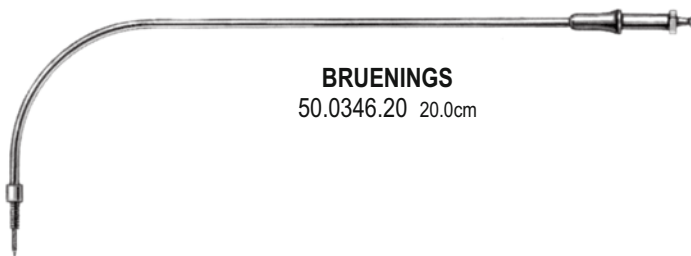

BRUENINGS
50.0346.20 20.0cm



FRAENKEL
50.0350.00



BARACANI
50.0354.00



SEIFFERT
50.0360.00



FRAENKEL
50.0364.00

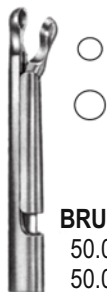

BRUENINGS
50.0370.01
50.0370.02



BRUENINGS
50.0374.01
50.0374.02



LANGE
50.0380.00



KRAUSE
50.0384.01
50.0384.02



SCHUMACHER
50.0390.00



CORDES
50.0394.01
50.0394.02



CORDES
50.0400.00



ROSENBERG
50.0404.00



KRAUSE
50.0410.00

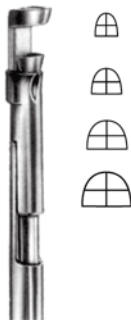

CORDES
50.0414.01
50.0414.02
50.0414.03
50.0414.04



SCHEINMANN
50.0420.00



SCHEINMANN
50.0424.00



50.0430.11



50.0434.10



50.0440.11



50.0444.12



50.0450.00



MICHEL
25.0cm



50.0460.12



50.0460.14



50.0460.16

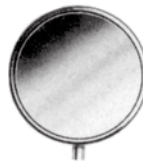

50.0460.18



50.0464.08
50.0464.10
50.0464.12
50.0464.14
50.0464.16
50.0464.18
50.0464.20
50.0464.22
50.0464.24
50.0464.26
50.0464.28
50.0464.30

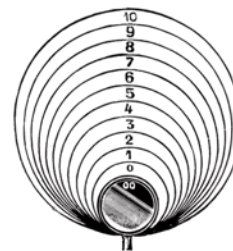

fig.00, 8mm Ø
fig.0, 10mm Ø
fig.1, 12mm Ø
fig.2, 14mm Ø
fig.3, 16mm Ø
fig.4, 18mm Ø
fig.5, 20mm Ø
fig.6, 22mm Ø
fig.7, 24mm Ø
fig.8, 26mm Ø
fig.9, 28mm Ø
fig.10, 30mm Ø



50.0466.08
50.0466.10
50.0466.12
50.0466.14
50.0466.16
50.0466.18
50.0466.20
50.0466.22
50.0466.24
50.0466.26
50.0466.28
50.0466.30



50.0470.01



50.0470.02



50.0470.03

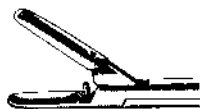

50.0470.04

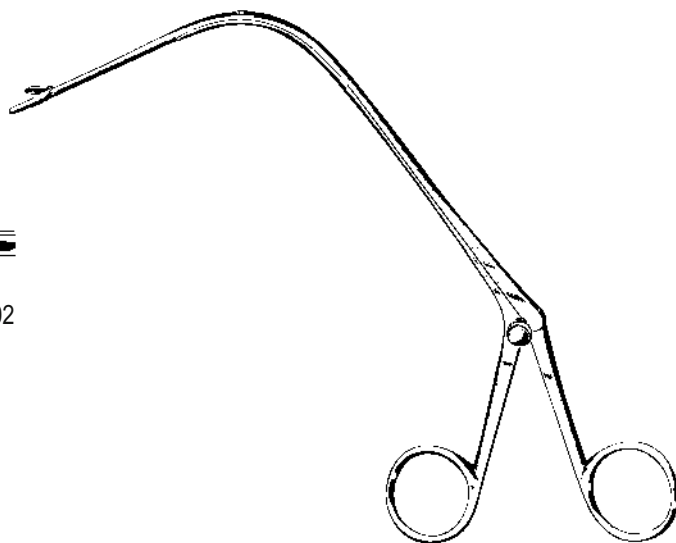

JURASZ
23.0cm

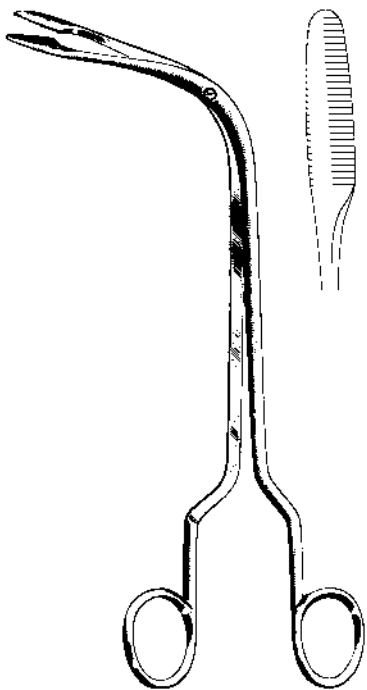

FRAENKEL
50.0474.19 19.0cm



JACKSON
22.0cm



50.0480.22



50.0482.22

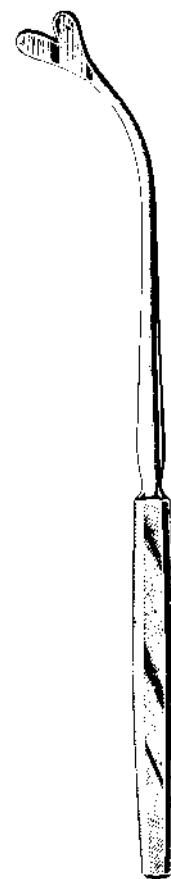

REICHERT
50.0486.24 24.0cm