

54

Страницы раздела
001-012

ИНСТРУМЕНТЫ РЕКТАЛЬНЫЕ RECTUM

Перейти в **СОДЕРЖАНИЕ**



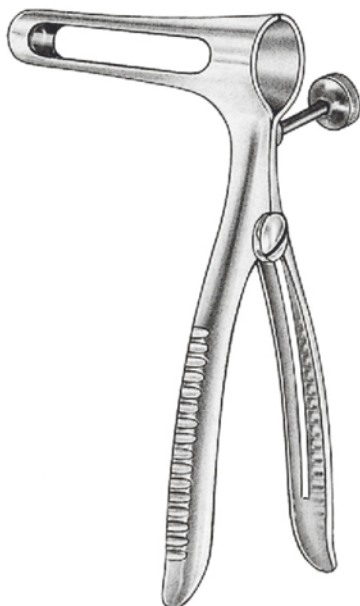

SIMS
54.0010.15 15.0cm

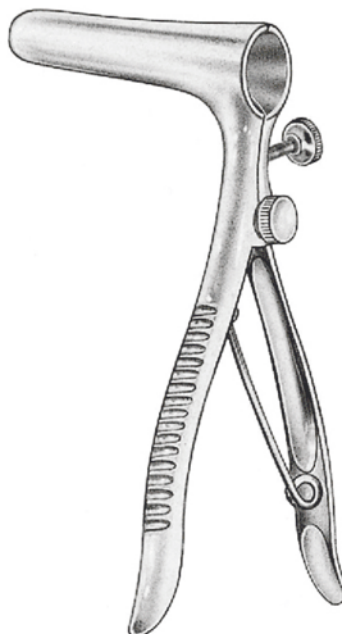

SIMS
54.0012.15 15.0cm



MATHIEU
54.0020.19 19.5cm

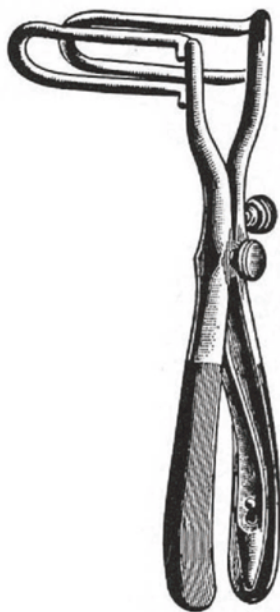

SIMS
54.0030.15 15.0cm



SCHULZE-BERGMANN
22.0cm
54.0040.06 60mm
54.0040.08 80mm
54.0040.12 125mm
54.0040.15 150mm



PRATT
54.0050.21 21.5cm

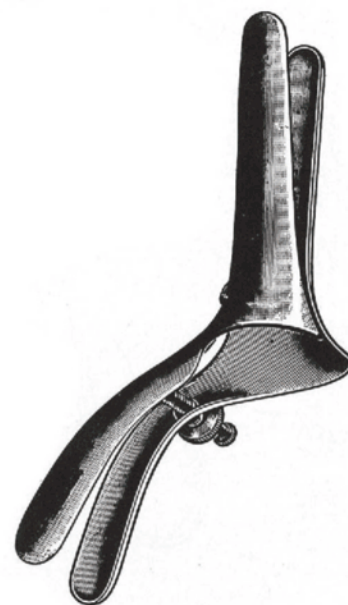

RICORD
54.0060.00



KELLY
54.0070.01 21mm Ø x 50mm
54.0070.02 27mm Ø x 50mm

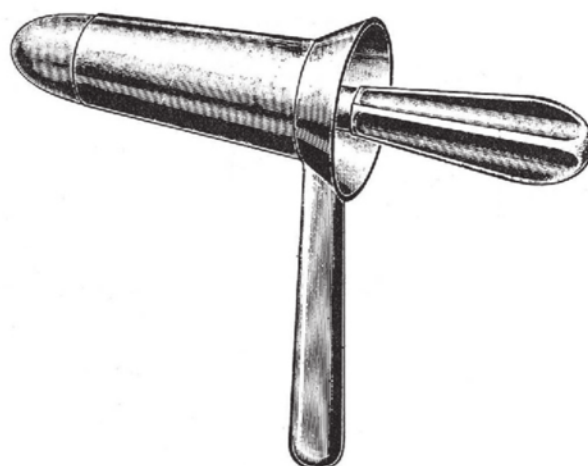

KELLY
54.0074.01 25mm Ø x 64mm
54.0074.02 22mm Ø x 35mm

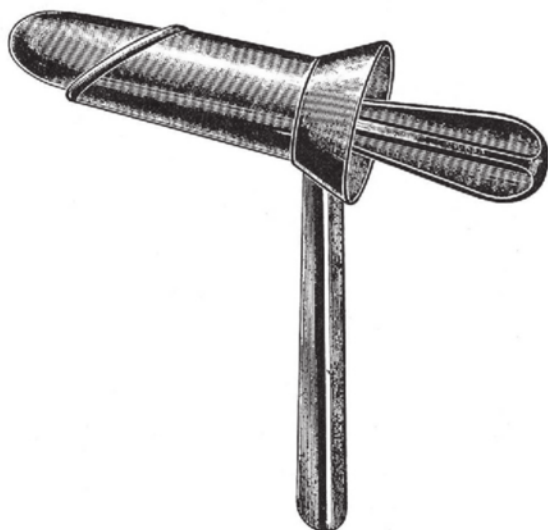

GRAEME-ANDERSON
54.0080.00 24mm Ø x 64mm



GABRIEL
54.0090.01 24mm Ø x 64mm
54.0090.02 19mm Ø x 49mm



KELLY

- 54.0100.01 22mm Ø x 50mm
- 54.0100.02 22mm Ø x 100mm
- 54.0100.03 22mm Ø x 140mm
- 54.0100.04 22mm Ø x 200mm

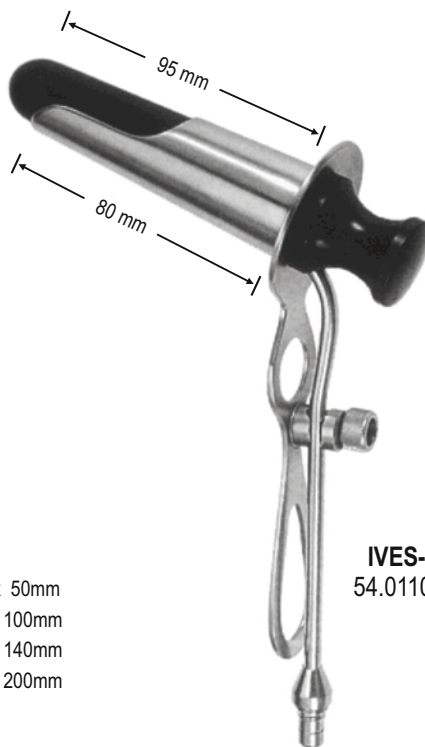

IVES-FANSLER

- 54.0110.15 22mm Ø



HIRSCHMANN

- 54.0120.01 16mm Ø x 65mm
- 54.0120.02 19mm Ø x 65mm
- 54.0120.03 22mm Ø x 65mm



KELLY

- 54.0130.01 22mm Ø x 50mm
- 54.0130.02 22mm Ø x 100mm
- 54.0130.03 22mm Ø x 140mm



MOD. MARTIN

- 54.0140.01 22mm Ø X 50mm
- 54.0140.02 22mm Ø X 75mm
- 54.0140.03 22mm Ø X 100mm



NEWMAN

- 54.0150.01 16mm Ø X 63mm
- 54.0150.02 19mm Ø X 63mm
- 54.0150.03 23mm Ø X 63mm



BENSAUDE

- 54.0160.01 19mmØ X 70mm
- 54.0160.02 22mmØ X 70mm



NAUNTON-MORGAN

- 54.0170.00 22mmØ X 70mm



BARR
54.0180.17 17.0cm

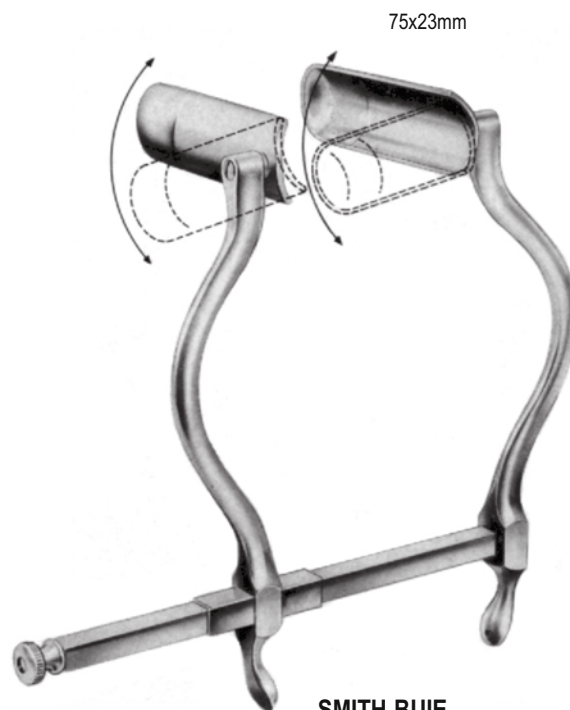

SMITH-BUIE
54.0190.15 15.0cm



ALAN PARKS
13.5cm
54.0200.00 complete
54.0200.04 centre blade
54.0200.13 frame only



54.0200.01
72mm



54.0200.02
90mm



54.0200.03
94mm

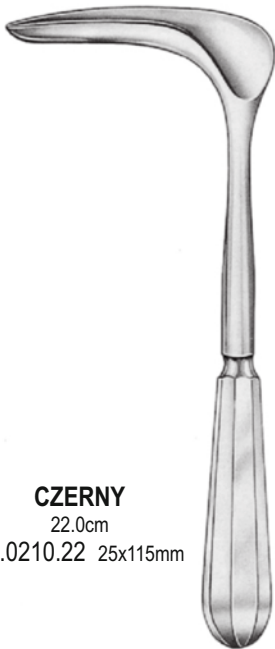

CZERNY
22.0cm
54.0210.22 25x115mm



SAWYER
23.0cm
54.0220.01 65x22mm
54.0220.02 75x28mm
54.0220.03 90x38mm



FERGUSON-MOON
21.0cm
54.0230.01 65x22mm
54.0230.02 75x28mm



BUIE 13.5cm
54.0240.13 light
54.0242.13 heavy



LARRY
54.0250.18
18.0cm



ROSER
54.0260.17
17.0cm



PRATT
22.0cm



54.0270.01



54.0270.02



54.0270.03



BARR
54.0280.23
23.0cm



BARR
54.0290.14
14.0cm



Fig.1

54.0300.01
Fig.1 straight

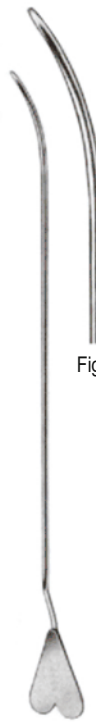

Fig.2

54.0300.02
Fig.2 45° curved



Fig.3

54.0300.03
Fig.3 90° curved

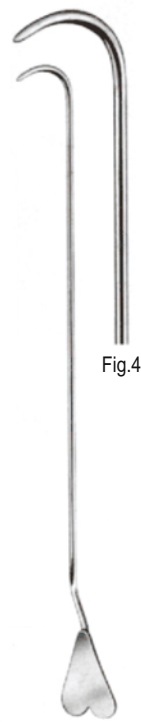

Fig.4

54.0300.04
Fig.4 retrograde curved



tip
3.5mm Ø

BRODIE 20.0cm

54.0310.20

LOCKHART-MUMMERY 16.5cm

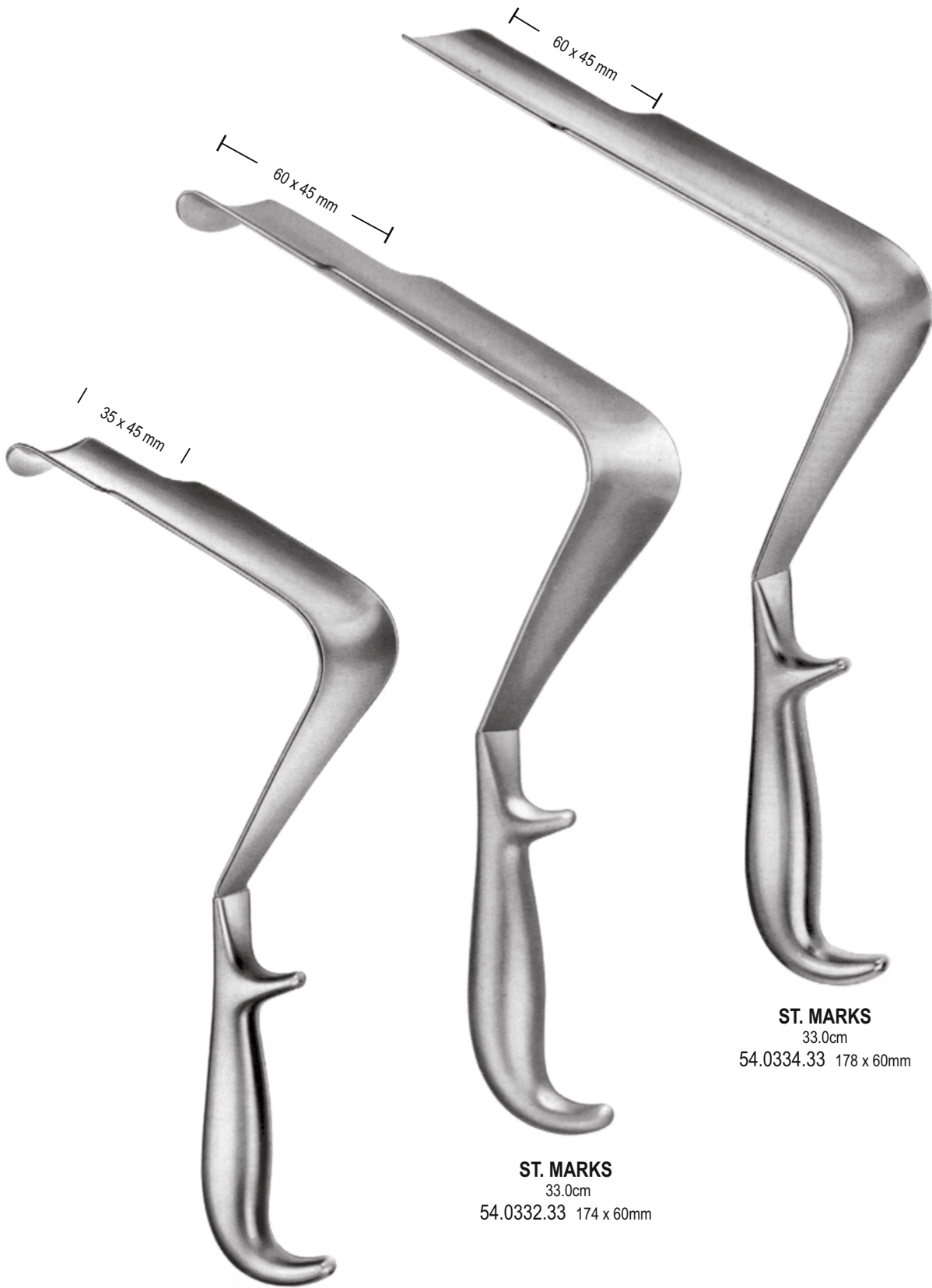

ST. MARKS
29.0cm
54.0330.29 124x60mm

ST. MARKS
33.0cm
54.0332.33 174 x 60mm

ST. MARKS
33.0cm
54.0334.33 178 x 60mm

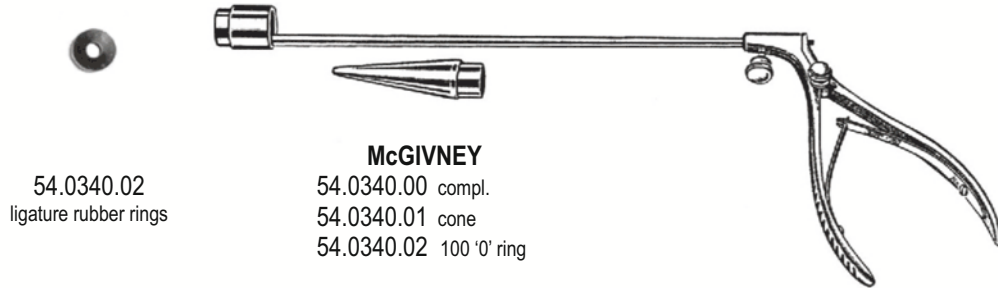

54.0340.02
ligature rubber rings

McGIVNEY
54.0340.00 compl.
54.0340.01 cone
54.0340.02 100 '0' ring

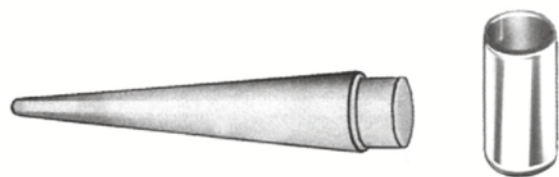

Loading Cone only
54.0354.01

Suction Head
54.0354.11 10x11mm
54.0354.16 10x16mm

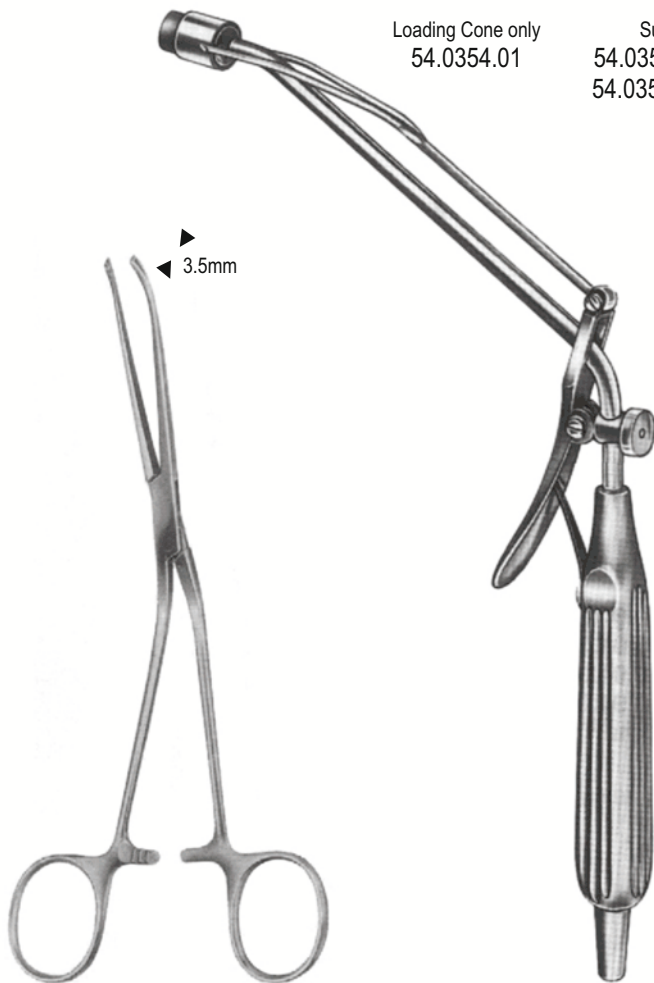

McGIVNEY
54.0350.18 18.5cm

18.5cm
54.0354.00 Set
54.0354.01 Cone
54.0354.11 Suction Head
54.0354.16 Suction Head
54.0340.02 100 '0' ring



RUDD
54.0360.31 31.5cm
54.0360.01 cone
54.0340.02 100 '0' ring

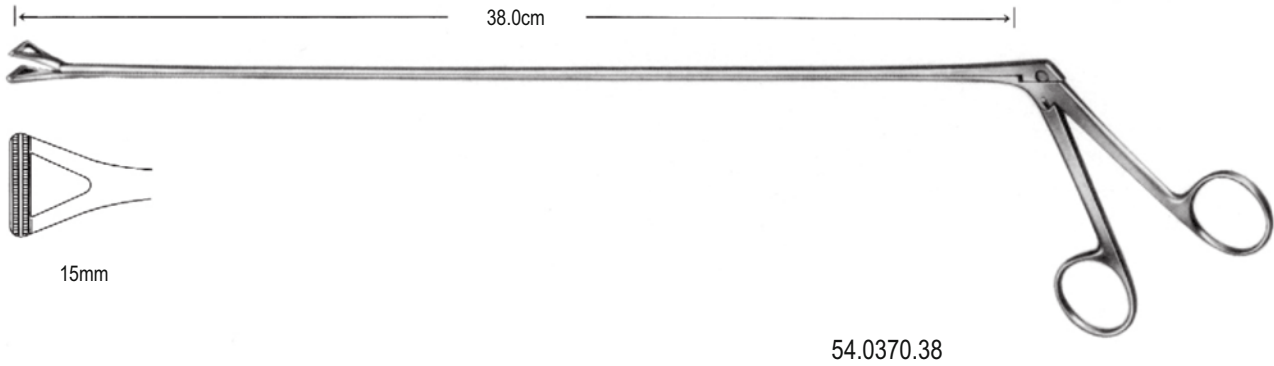

HEYWOOD-SMITH
54.0380.21 21.0cm

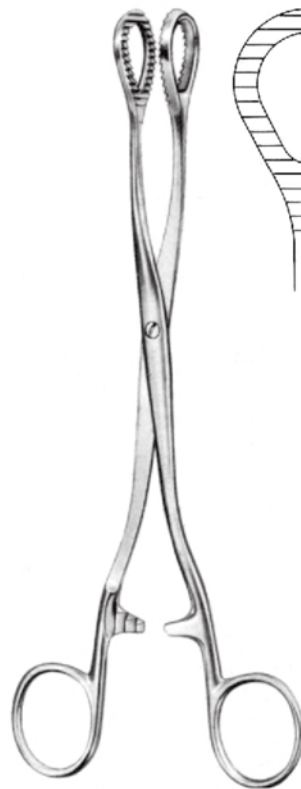
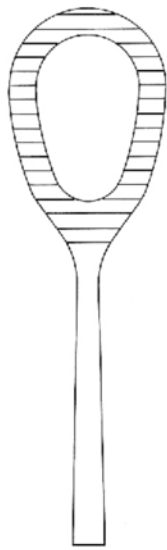

HEYWOOD-SMITH
54.0382.20 20.0cm

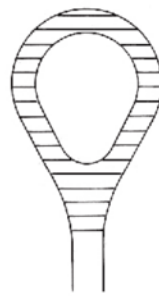

LUER
54.0390.24 24.5cm

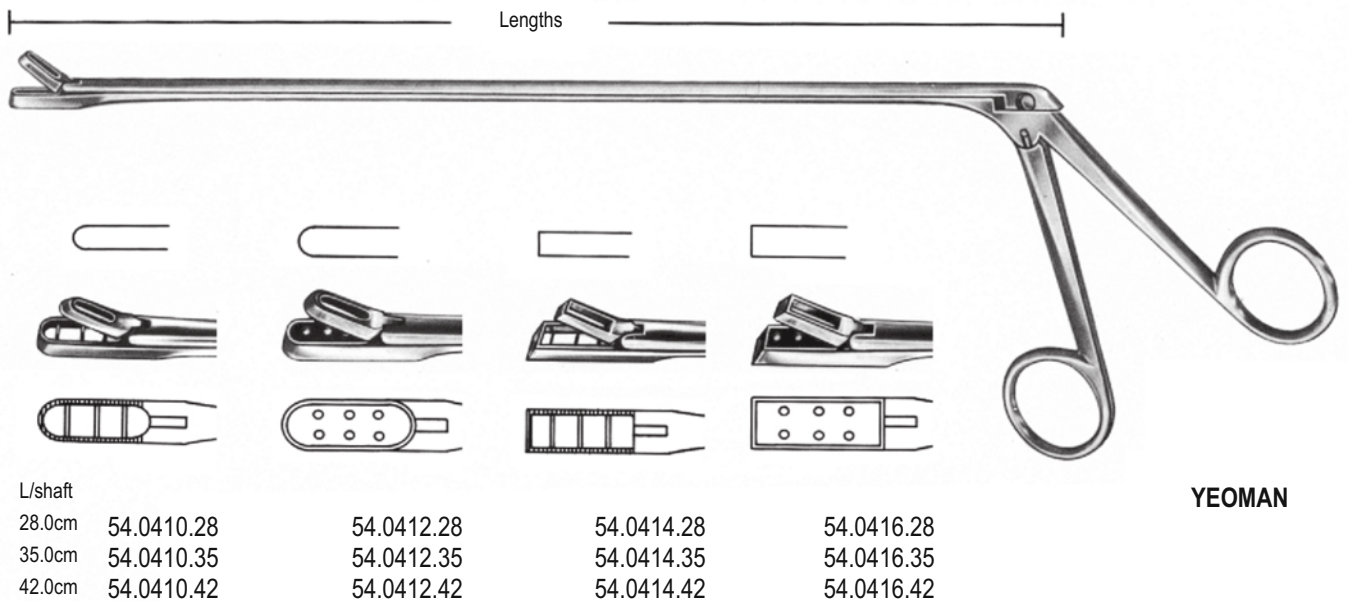
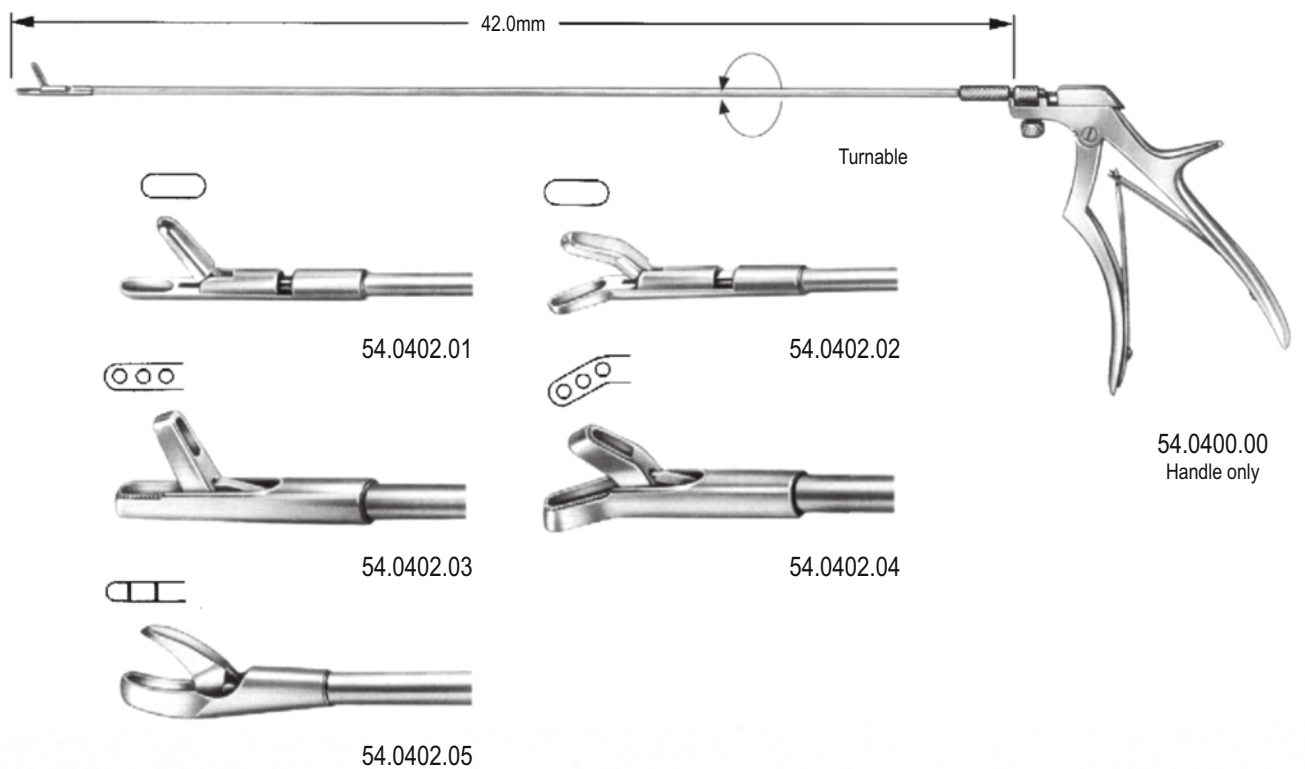

YEOMAN

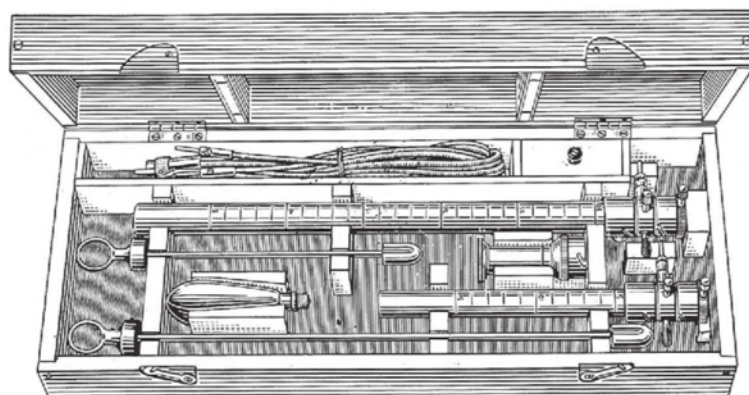

LLOYDS-DAVIES
54.0420.00 complete

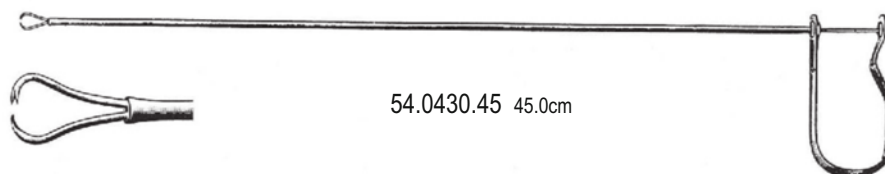

54.0430.45 45.0cm

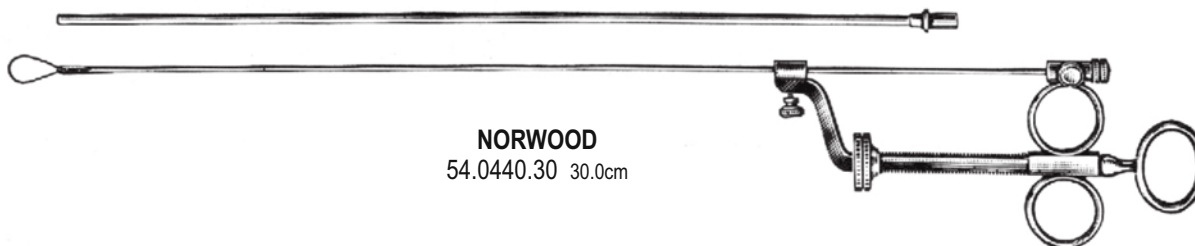

NORWOOD
54.0440.30 30.0cm

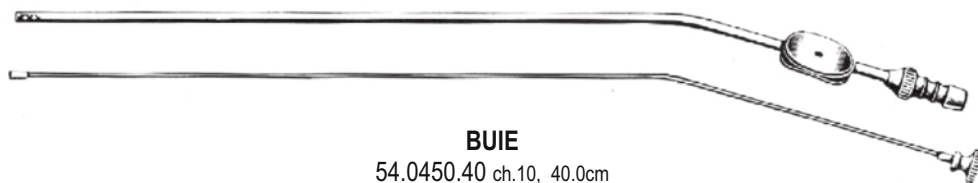

BUIE
54.0450.40 ch.10, 40.0cm

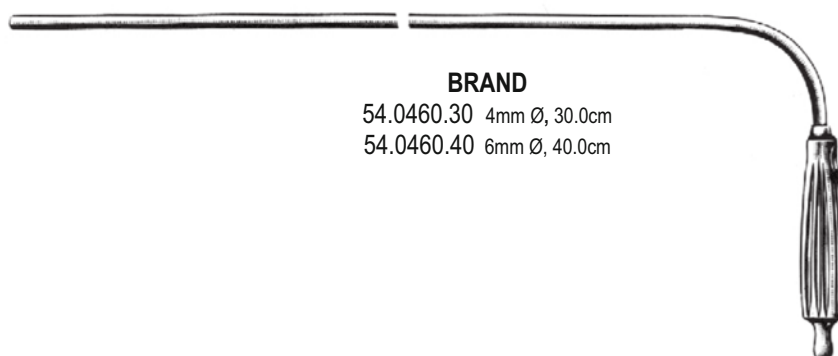

BRAND
54.0460.30 4mm Ø, 30.0cm
54.0460.40 6mm Ø, 40.0cm