

# 60

Страницы раздела  
001-042

## ГИНЕКОЛОГИЯ GYNECOLOGY

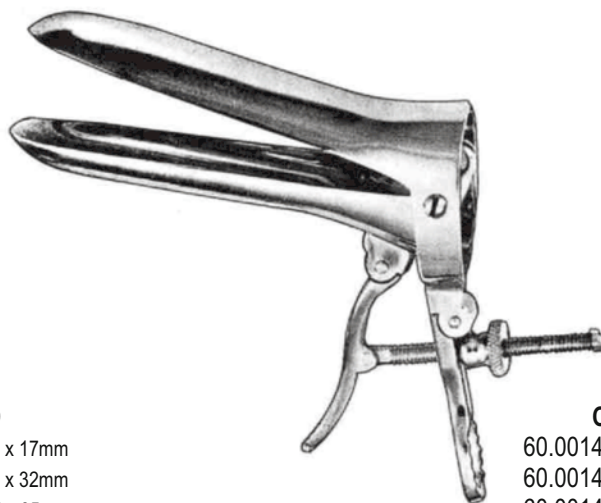
Перейти в **СОДЕРЖАНИЕ**



# 60 | Зеркала гинекологические Vaginal Specula



**CUSCO**  
60.0010.01 75 x 17mm  
60.0010.02 75 x 32mm  
60.0010.03 85 x 35mm  
60.0010.04 100 x 37mm



**CUSCO**  
60.0014.01 75 x 17mm  
60.0014.02 75 x 32mm  
60.0014.03 80 x 32mm  
60.0014.04 85 x 35mm  
60.0014.05 110 x 35mm  
60.0014.06 115 x 37mm



**CUSCO**  
60.0020.01 75 x 32mm  
60.0020.02 85 x 35mm  
60.0020.03 100 x 35mm  
60.0020.04 85 x 35mm ( with cold light carrier)  
60.0020.05 (cold light carrier only)



**CUSCO**  
60.0022.01 75 x 17mm  
60.0022.02 85 x 17mm  
60.0022.03 100 x 17mm



**CUSCO (Swiss pattern)**  
60.0024.01 80 x 22mm  
60.0024.02 100 x 25mm  
60.0024.03 105 x 27mm  
60.0024.04 115 x 27mm



**CUSCO'S**  
60.0026.01 (LL)  
60.0026.02 (L)  
60.0026.03 (M)  
60.0026.04 (S)  
60.0026.05 (SS)  
60.0026.06 (SSS)



**PEDERSON**

- 60.0030.01 75 x 13mm
- 60.0030.02 100 x 22mm
- 60.0030.03 120 x 25mm
- 60.0030.04 130 x 25mm



**GRAVE**

- 60.0034.01 75 x 20mm
- 60.0034.02 95 x 35mm
- 60.0034.03 115 x 35mm
- 60.0034.04 125 x 35mm



**SEMM**

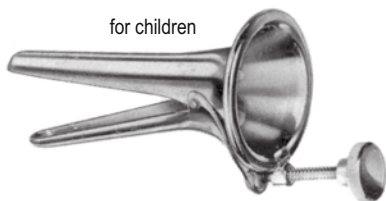
- 60.0040.01 100 x 17/20mm
- 60.0040.02 100 x 25/30mm



**FERGUSSON**

- 60.0050.01 25mm Ø
- 60.0050.02 30mm Ø
- 60.0050.03 35mm Ø
- 60.0050.04 40mm Ø

# 60 | Зеркала гинекологические Vaginal Specula



for children

**COLLIN**  
60.0054.01 55 x 10mm



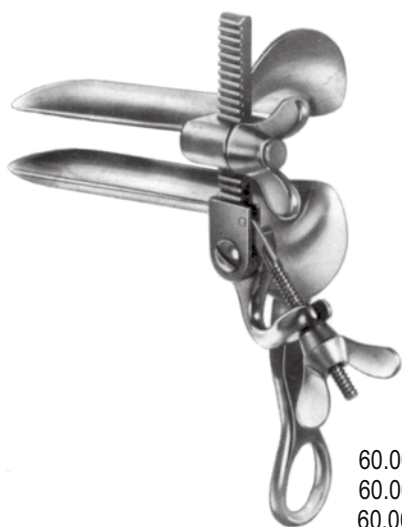
**COLLIN**  
60.0060.01 65 x 20mm



**COLLIN-LANDAU**  
60.0064.01 100 x 35mm



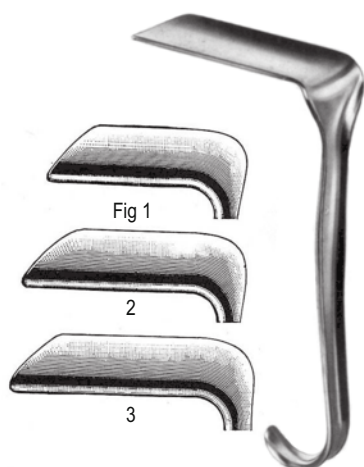
**COLLIN**  
60.0066.01 85 x 30mm  
60.0066.02 100 x 35mm  
60.0066.03 110 x 40mm  
60.0066.04 100 x 35mm (with cold light carrier)  
60.0066.05 (cold light carrier only)



**TRELAT**  
60.0068.01 85 x 33mm  
60.0068.02 95 x 35mm  
60.0068.03 115 x 43mm

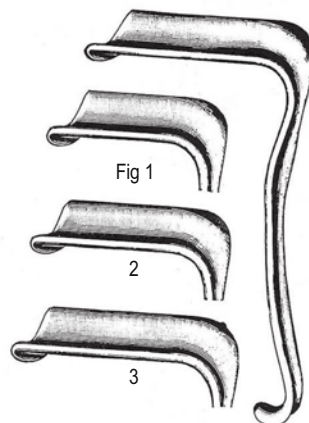


**SAKURAI'S**  
60.0070.01 (LL)  
60.0070.02 (L)  
60.0070.03 (M)  
60.0070.04 (S)



**JACKSON**

- 60.0080.01 75 x 35mm
- 60.0080.02 90 x 35mm
- 60.0080.03 100 x 35mm
- 60.0080.04 75 x 40mm
- 60.0080.05 90 x 40mm
- 60.0080.06 100 x 40mm



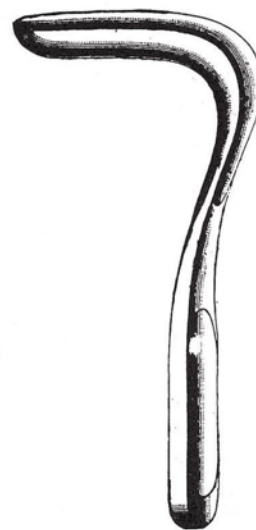
**EASTMANN**

- 60.0084.01 75 x 35mm
- 60.0084.02 90 x 35mm
- 60.0084.03 100 x 35mm
- 60.0084.04 75 x 40mm
- 60.0084.05 90 x 40mm
- 60.0084.06 100 x 40mm



**SIMS**

- 60.0090.01 65 x 25, 70 x 30mm
- 60.0090.02 70 x 30, 70 x 35mm
- 60.0090.03 85 x 35, 90 x 40mm
- 60.0090.04 100 x 35 x 40mm
- 60.0090.05 120 x 35 x 40mm



**SIMS**

- 60.0094.01 60 x 25mm
- 60.0094.02 70 x 30mm
- 60.0094.03 80 x 35mm

# 60 | Зеркала гинекологические Ретракторы гинекологические

Vaginal Specula and Retractors



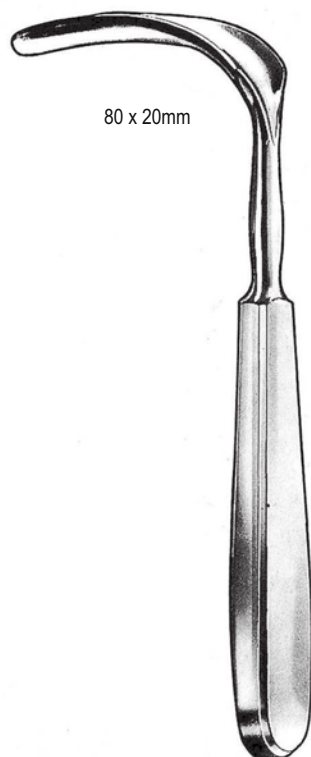
56 x 13mm

**BRAUN**  
60.0100.18 18.0cm



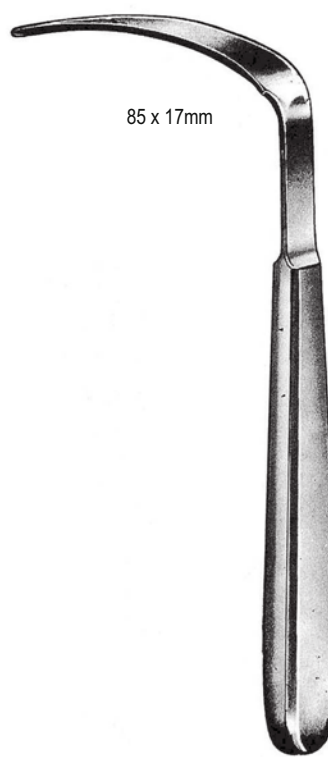
60 x 10mm

**BRAUN**  
60.0102.18 18.0cm



80 x 20mm

**ULRICH**  
60.0110.19 19.5cm



85 x 17mm

60.0112.19 19.0cm



**KRISTELLER**  
specula

Fig 1. 60.0120.01 110 x 18mm  
Fig 2. 60.0120.02 110 x 21mm



**KRISTELLER**  
retractors

Fig 1. 60.0122.01 115 x 14mm  
Fig 2. 60.0122.02 115 x 17mm



**KRISTELLER**  
set of 1 speculum and 1 retractor each  
Fig 1. 60.0124.00  
Fig 2. 60.0126.00



**KRISTELLER**  
specula

Fig.1 60.0130.01 70 x 27mm  
Fig.2 60.0130.02 80 x 30mm  
Fig.3 60.0130.03 90 x 36mm



**KRISTELLER**  
retractors

Fig.1 60.0132.01 75 x 23mm  
Fig.2 60.0132.02 85 x 26mm  
Fig.3 60.0132.03 100 x 32mm



**KRISTELLER**  
set of 1 speculum and 1 retractors each  
Fig.1 60.0134.00  
Fig.2 60.0136.00  
Fig.3 60.0138.00



**KRISTELLER**  
specula

60.0140.01 110 x 27mm  
60.0140.02 110 x 30mm  
60.0140.03 110 x 36mm



**KRISTELLER**  
retractors

60.0142.01 115 x 23mm  
60.0142.02 115 x 26mm  
60.0142.03 115 x 32mm



**KRISTELLER**  
set of 1 speculum and 1 retractor each

60.0144.00  
60.0146.00  
60.0148.00



**KRISTELLER**  
specula

Fig.1 60.0150.01 105 x 26mm  
Fig.2 60.0150.02 105 x 28mm  
Fig.3 60.0150.03 105 x 33mm



**KRISTELLER**  
retractors

Fig.1 60.0152.01 115 x 22mm  
Fig.2 60.0152.02 115 x 24mm  
Fig.3 60.0152.03 115 x 29mm



**KRISTELLER**  
set of 1 speculum and 1 retractors each

Fig.1 60.0154.00  
Fig.2 60.0156.00  
Fig.3 60.0158.00





extra large pattern

60.0160.01  
140 x 30mm



60.0162.01  
135 x 36mm



60.0164.01  
135 x 36mm



vaginal specula

vaginal retractors

**KALLMORGEN**

60.0170.01 70 x 40mm  
60.0170.02 90 x 40mm  
set  
60.0174.00  
60.0176.00

60.0172.01 70 x 33mm  
60.0172.02 90 x 33mm



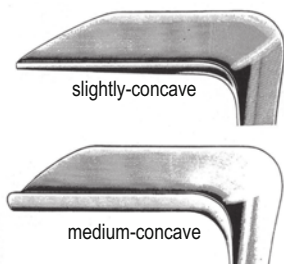
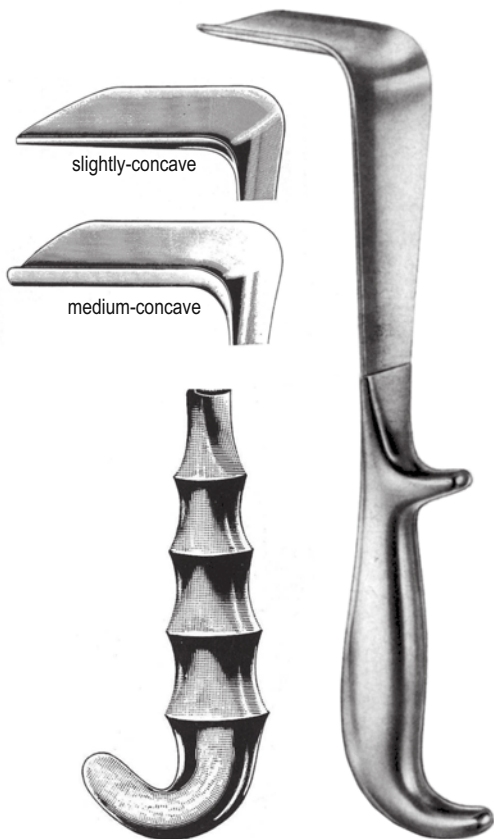
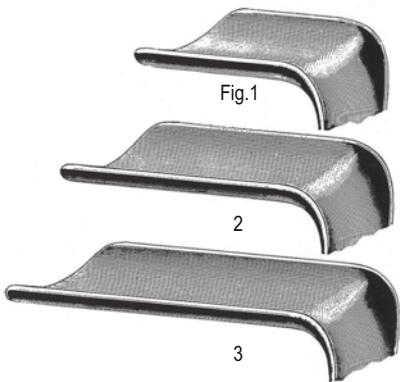
vaginal specula

vaginal retractors

**MATHIEU**

60.0180.01 95 x 16mm  
95 x 26mm  
60.0180.02 95 x 26mm  
95 x 30mm  
set  
60.0184.00  
60.0186.00

60.0182.01 100 x 11mm  
100 x 20mm  
60.0182.02 100 x 14mm  
100 x 26mm



DOYEN FG

DOYEN

Fig	mm	mm	slightly-concave	slightly-concave	medium-concave
1	55	35	60.0190.01	60.0200.01	60.0210.01
2	85	35	60.0190.02	60.0200.02	60.0210.02
3	115	35	60.0190.03	60.0200.03	60.0210.03
1	55	45	60.0192.01	60.0202.01	60.0212.01
2	85	45	60.0192.02	60.0202.02	60.0212.02
3	115	45	60.0192.03	60.0202.03	60.0212.03
1	55	60	60.0194.01	60.0204.01	60.0214.01
2	85	60	60.0194.02	60.0204.02	60.0214.02
3	115	60	60.0194.03	60.0204.03	60.0214.03

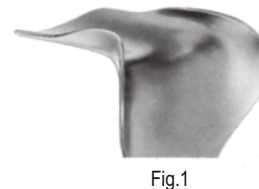


Fig.1



Fig.2



Fig.3

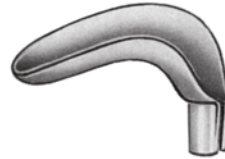


DOYEN

60.0220.01 75 x 45mm  
60.0220.02 90 x 45mm  
60.0220.03 110 x 45mm



60.0230.01



60.0230.02



60.0230.03



60.0230.04



60.0230.05

60.0230.40  
weight, light, 400gm  
60.0230.80  
weight, heavy, 800gm

**SCHERBAK**

60.0230.00 set complete  
60.0230.10 handle only



**A**  
60.0242.10  
handle only



70 x 30mm  
60.0244.01



80 x 35mm  
60.0244.02



90 x 35mm  
60.0244.03



100 x 35mm  
60.0244.04



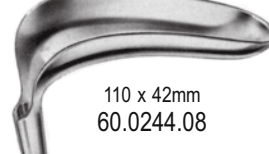
80 x 30mm  
60.0244.05



85 x 33mm  
60.0244.06



100 x 35mm  
60.0244.07



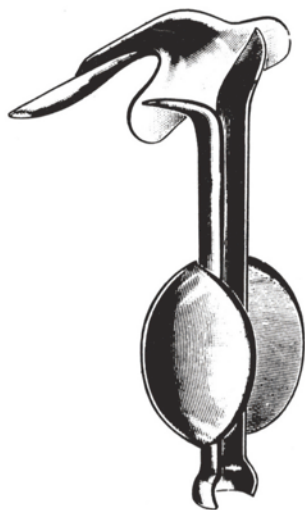
110 x 42mm  
60.0244.08



**B**  
60.0244.10  
handle only

**BOZEMANN**

60.0240.00 compl. set with handle A, B and 8 blades  
60.0242.00 compl. set with handle A and 8 blades  
60.0244.00 compl. set with handle B and 8 blades



**AUVARD**

60.0250.01 80 x 38mm 2 lbs  
60.0250.02 80 x 38mm 2.5 lbs  
60.0250.03 80 x 38mm 3 lbs



**AUVARD**

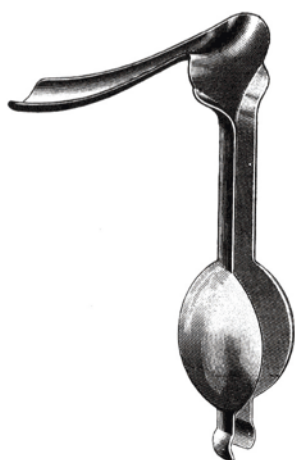
60.0254.00 68 x 40mm 3 lbs



80 x 38 mm

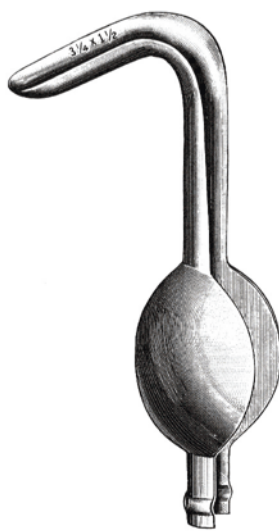
**AUVARD**

60.0260.01 2.5 lbs  
60.0260.02 3 lbs



**STEINER-AUVARD**

60.0264.01 140 x 35mm 2.5 lbs  
60.0266.01 140 x 35mm 2.5 lbs  
laser pattern



**HENROTIN**

60.0270.01 80 x 35mm 3 lbs  
30° blade angled down



**BERLIND-AUVARD**

60.0274.01 105 x 40mm 2.5 lbs



**LANDAU**

60.0300.01 105 x 28mm  
60.0300.02 105 x 38mm



**BREISKY**

60.0304.01 100 x 20mm  
60.0304.02 100 x 25mm  
60.0304.03 100 x 30mm  
60.0304.04 100 x 35mm  
60.0304.05 100 x 40mm  
  
60.0306.01 130 x 20mm  
60.0306.02 130 x 25mm  
60.0306.03 130 x 30mm  
60.0306.04 130 x 35mm  
60.0306.05 130 x 40mm  
  
60.0308.01 155 x 40mm



**DUNKEL**

60.0310.22



**O'SULLIVAN-O'CONNOR**  
60.0314.00 set complete



60.0314.01 Fig. 1 = 45 x 17mm  
60.0314.02 Fig. 2 = 90 x 37mm  
60.0314.03 Fig. 3 = 90 x 45mm

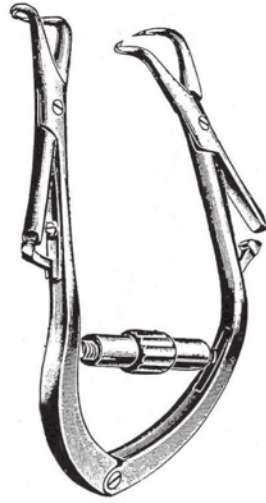


70 x 30mm

**DOYEN**  
60.0320.24 24.0cm



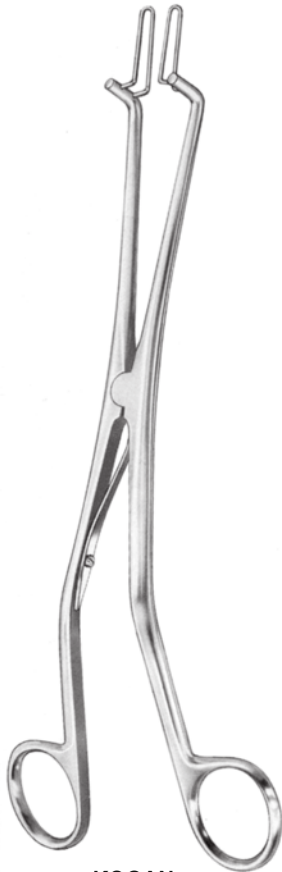
**FRIEDMAN**  
60.0324.10 10.0cm



**JOLL**  
60.0330.15 15.0cm



**COMYNS-BERKELEY**  
60.0334.00



**KOGAN**  
24.0cm  
60.0340.24 2/4mm  
60.0340.48 4/8mm

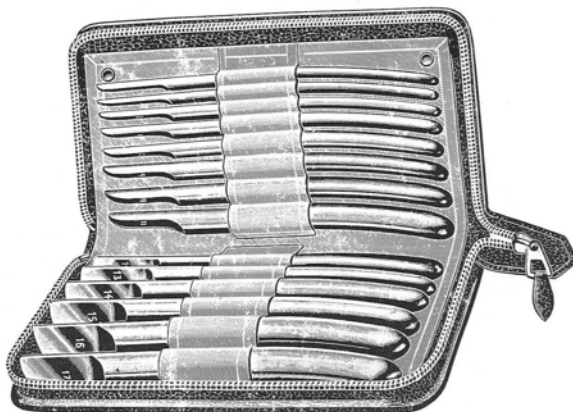


**KOGAN**  
24.0cm laser  
60.0344.24 2/4mm 60.0346.24  
60.0344.48 4/8mm 60.0346.48



**HEGAR**  
60.0350.01 - 60.0350.30  
(1.0mm - 30.0mm)

	mm dia.		mm dia.
60.0350.01	1.0	60.0351.01	1.5
60.0350.02	2.0	60.0351.02	2.5
60.0350.03	3.0	60.0351.03	3.5
60.0350.04	4.0	60.0351.04	4.5
60.0350.05	5.0	60.0351.05	5.5
60.0350.06	6.0	60.0351.06	6.5
60.0350.07	7.0	60.0351.07	7.5
60.0350.08	8.0	60.0351.08	8.5
60.0350.09	9.0	60.0351.09	9.5
60.0350.10	10.0	60.0351.10	10.5
60.0350.11	11.0	60.0351.11	11.5
60.0350.12	12.0	60.0351.12	12.5
60.0350.13	13.0	60.0351.13	13.5
60.0350.14	14.0	60.0351.14	14.5
60.0350.15	15.0	60.0351.15	15.5
60.0350.16	16.0	60.0351.16	16.5
60.0350.17	17.0	60.0351.17	17.5
60.0350.18	18.0	60.0351.18	18.5
60.0350.19	19.0	60.0351.19	19.5
60.0350.20	20.0	60.0351.20	20.5
60.0350.21	21.0	60.0351.21	21.5
60.0350.22	22.0	60.0351.22	22.5
60.0350.23	23.0	60.0351.23	23.5
60.0350.24	24.0	60.0351.24	24.5
60.0350.25	25.0	60.0351.25	25.5
60.0350.26	26.0	60.0351.26	26.5
60.0350.27	27.0	60.0351.27	27.5
60.0350.28	28.0	60.0351.28	28.5
60.0350.29	29.0	60.0351.29	29.5
60.0350.30	30.0	60.0351.30	30.5



**HEGAR**  
60.0350.00 (4 to 17 mm dia)  
set of 14

60.0352.00 (1 to 26 mm dia)  
set of 26

60.0354.00 (1 to 30 mm dia)  
set of 30



**HEGAR**  
60.0360.00 (4 to 17 mm dia)  
set of 14

60.0362.00 (1 to 26 mm dia)  
set of 26

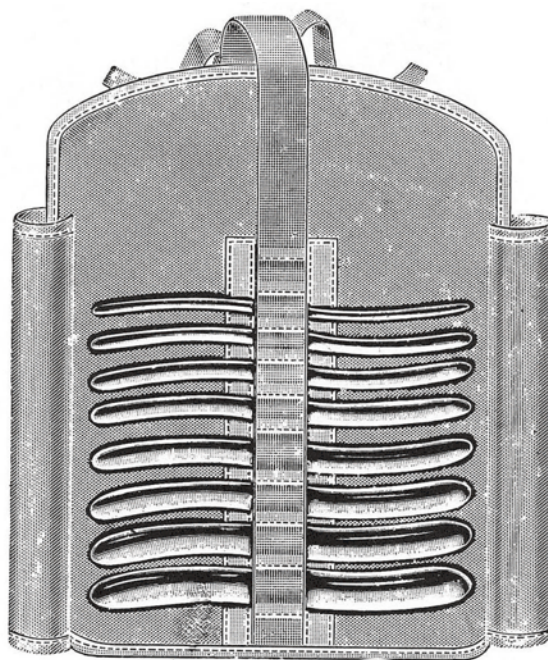
60.0364.00 (1 to 30 mm dia)  
set of 30



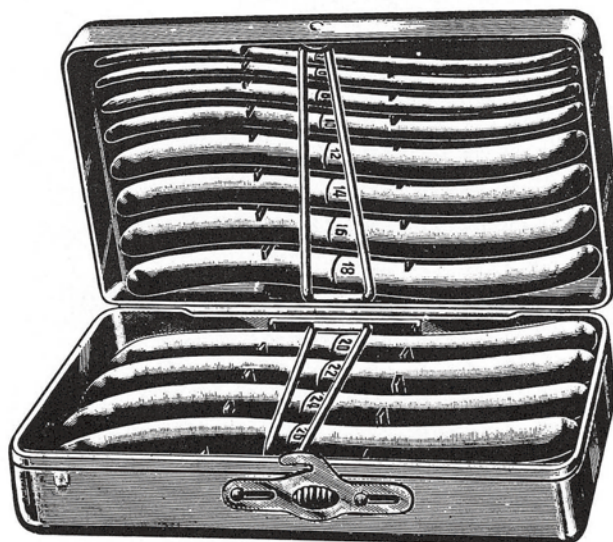


**HEGAR**  
60.0370.01 - 60.0370.25  
(1/2 - 25/26 mm dia.)

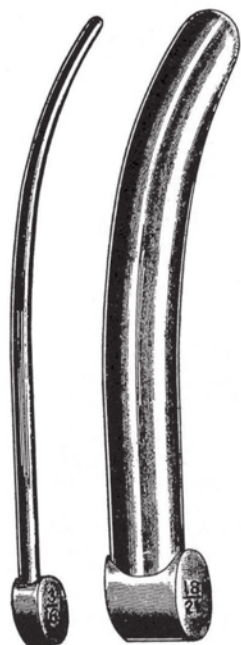
	mm dia.
60.0370.01	1/2
60.0370.03	3/4
60.0370.05	5/6
60.0370.07	7/8
60.0370.09	9/10
60.0370.11	11/12
60.0370.13	13/14
60.0370.15	15/16
60.0370.17	17/18
60.0370.19	19/20
60.0370.21	21/22
60.0370.23	23/24
60.0370.25	25/26



**HEGAR**  
60.0370.00 set of 8 (3/4 to 17/18 mm dia)  
60.0372.00 set of 13 (1/2 to 25/26 mm dia)



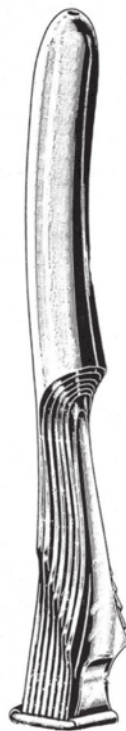
**HEGAR**  
60.0380.00 set of 8 (3/4 to 17/18 mm dia)  
60.0382.00 set of 13 (1/2 to 25/26 mm dia)



	mm dia.
60.0390.01	3/6
60.0390.02	4/7
60.0390.03	5/8
60.0390.04	6/9
60.0390.05	7/10
60.0390.06	8/11
60.0390.07	9/12
60.0390.08	10/13
60.0390.09	11/14
60.0390.10	12/15
60.0390.11	13/16
60.0390.12	14/17
60.0390.13	15/18
60.0390.14	16/19
60.0390.15	17/20
60.0390.16	18/21

**HAWKINS-AMBLER**

60.0390.00 set of 12  
60.0392.00 set of 16



60.0400.01	3-7 mm dia
60.0400.02	5-9 mm dia
60.0400.03	7-12 mm dia
60.0400.04	9-15 mm dia
60.0400.05	12-18 mm dia

**JOLLY**

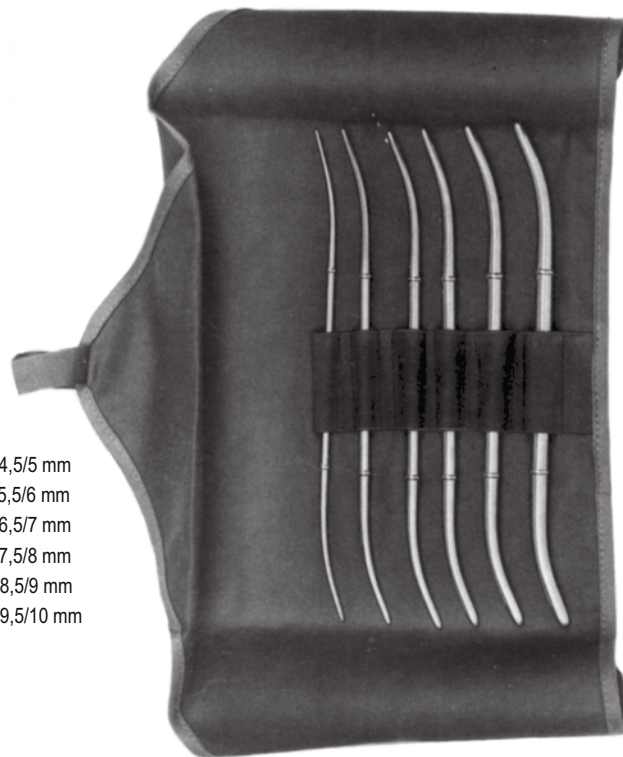
60.0400.00 set of 5



**HANK**

60.0404.00 set

Fig.9/10	60.0404.01	4,5/5 mm
Fig.11/12	60.0404.02	5,5/6 mm
Fig.13/14	60.0404.03	6,5/7 mm
Fig.15/16	60.0404.04	7,5/8 mm
Fig.17/18	60.0404.05	8,5/9 mm
Fig.19/20	60.0404.06	9,5/10 mm



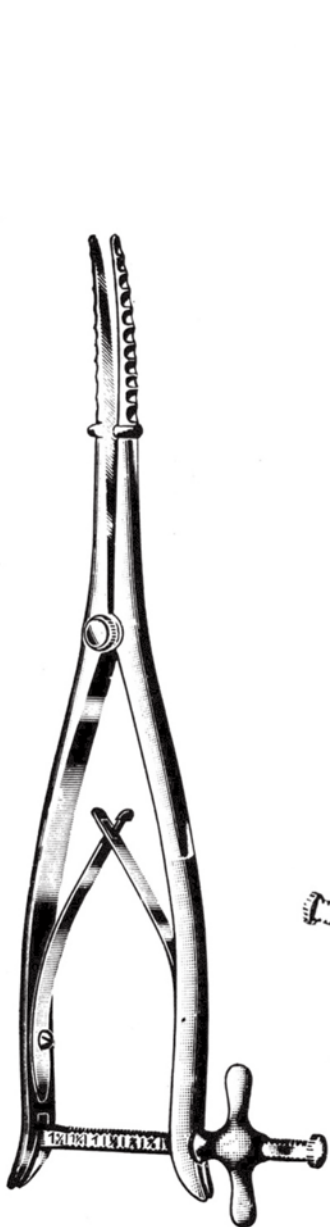
**HANK**

60.0406.00 set

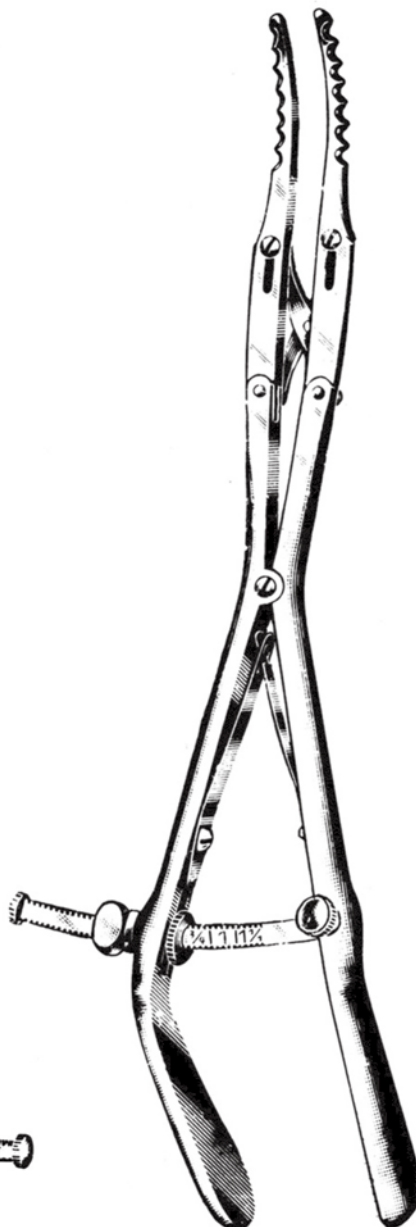
mm	
1	60.0410.01
2	60.0410.02
3	60.0410.03
4	60.0410.04
5	60.0410.05
6	60.0410.06
7	60.0410.07
8	60.0410.08
9	60.0410.09
10	60.0410.10
11	60.0410.11
12	60.0410.12
13	60.0410.13
14	60.0410.14
15	60.0410.15
16	60.0410.16
17	60.0410.17
18	60.0410.18
19	60.0410.19
20	60.0410.20



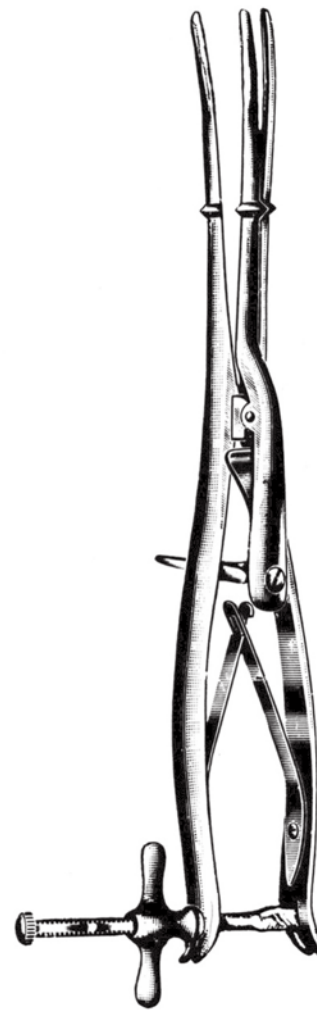
**HEGAR** set  
60.0410.00 1 to 13mm  
60.0412.00 1 to 20mm  
60.0414.00 14 to 20mm



**WYLIE**  
60.0420.29 serrated  
60.0422.29 smooth  
29.0cm



**GOODELL**  
60.0426.34 34.0cm



**SIMS**  
60.0430.29 29.0cm



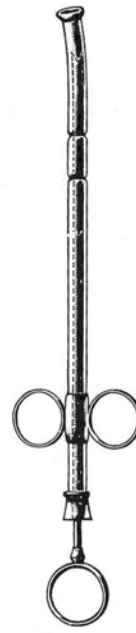
**BRAUN**  
60.0440.28 28.0cm



**SIMS**  
60.0444.26 26.0cm



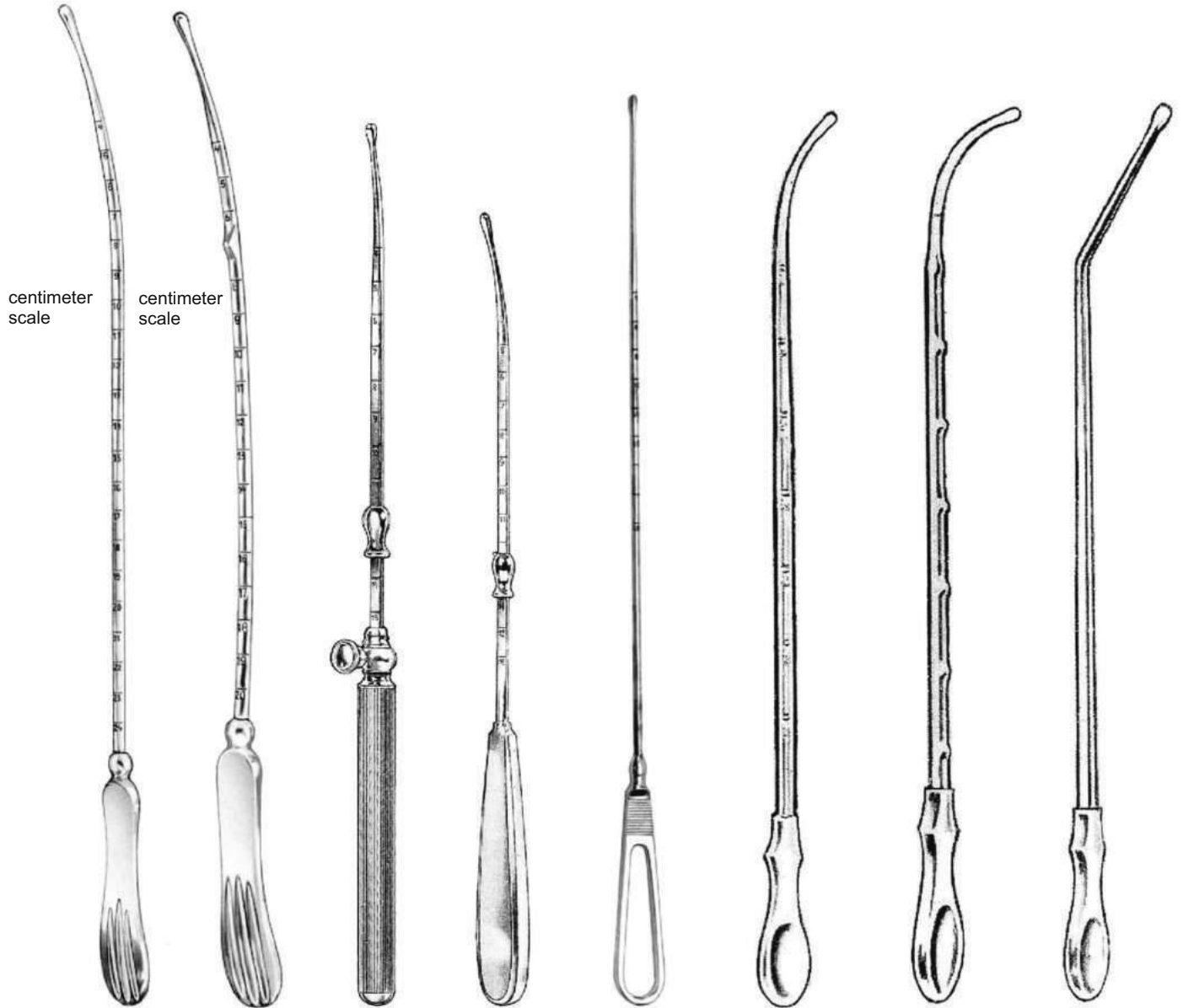
**FANO**  
60.0450.22 22.0cm



**RAPID**  
60.0454.01 200 x 8mm  
60.0454.02 250 x 10mm  
60.0454.03 250 x 12mm



**SIMS**  
60.0460.27 27.0cm



centimeter  
scale

centimeter  
scale

**SIMS**  
60.0470.32  
rigid

**MARTIN**  
60.0476.32  
rigid

**COLLIN**  
60.0480.28  
28.0cm

**VALLEIX**  
60.0486.25  
25.0cm

60.0490.30  
30.5cm

**GALABIN**  
60.0496.32  
32.0cm

**HORROCKS**  
60.0500.32  
32.0cm

**SIMPSON**  
60.0504.32  
32.0cm

60.0472.32  
malleable  
32.0cm

60.0478.32  
malleable  
32.0cm



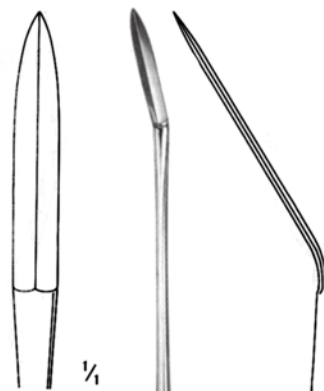
**DOYEN**  
17.0cm  
60.0510.01 T-handle  
60.0510.02 loop handle



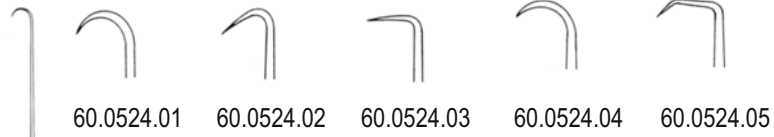
**DOYEN**  
17.0cm  
60.0512.01 T-handle  
60.0512.02 loop handle



**SEGOND**  
60.0516.27 27.0cm



**AYRE**  
60.0520.23 23.0cm



**EMMET**  
22.0cm



60.0526.24 24.0cm



**SIMON**  
60.0530.22 22.0cm

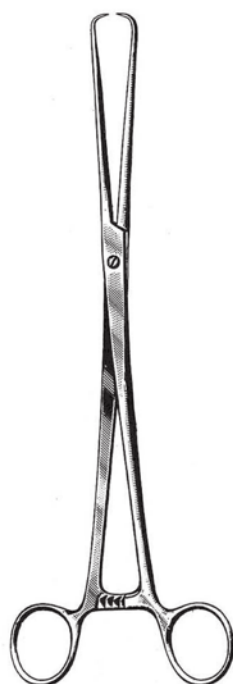


**SIMON**  
60.0532.22 22.0cm

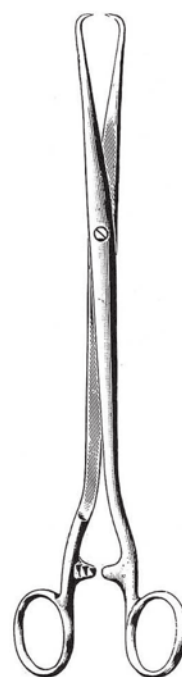




**POZZI**  
60.0540.25 25.0cm



**POZZI**  
60.0542.25 25.0cm



**SCHROEDER**  
60.0546.25 25.0cm



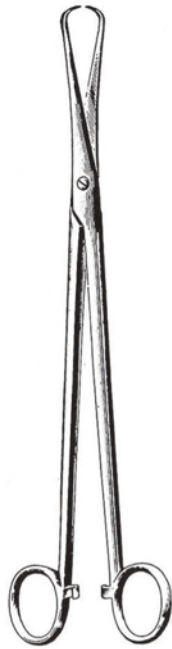
**STAUDE-MOORE**  
60.0550.17 17.0cm  
strong pattern



**BARRETT**  
60.0554.18 18.0cm



**POZZI**  
60.0560.25 25.5cm



**MARTIN**  
60.0564.27 27.0cm



**SKENE**  
60.0570.24 24.0cm



**SKENE**  
60.0574.23 23.0cm



**ABEL**  
60.0576.27 27.0cm



**SCHROEDER**  
60.0580.25 25.0cm



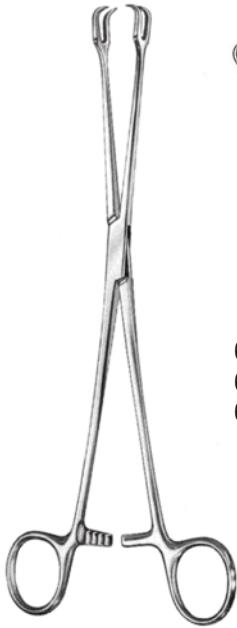
**BRAUN**  
60.0584.25 25.0cm



**DUPLAY**  
60.0590.28 28.0cm



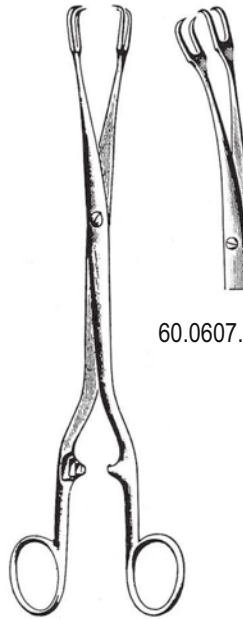
**BEACHAM**  
60.0594.26 26.0cm



60.0601.23 23.0cm 60.0603.23  
60.0601.24 24.0cm 60.0603.24  
60.0601.26 26.0cm 60.0603.26

**SCHROEDER**

60.0600.23 23.0cm  
60.0600.24 24.0cm  
60.0600.26 26.0cm



60.0607.26 26.0cm

**SCHROEDER**

60.0606.26 26.0cm



**TEALE**

60.0610.18 18.0cm  
60.0610.23 23.0cm



**TEALE**

60.0614.18 18.0cm  
60.0614.23 23.0cm  
60.0614.25 25.0cm



**IOWA**

60.0620.26 26.0cm



**MUSEUX**

straight	24.0cm	curved sideway
60.0630.06	6mm	60.0631.06
60.0630.08	8mm	60.0631.08
60.0630.10	10mm	60.0631.10



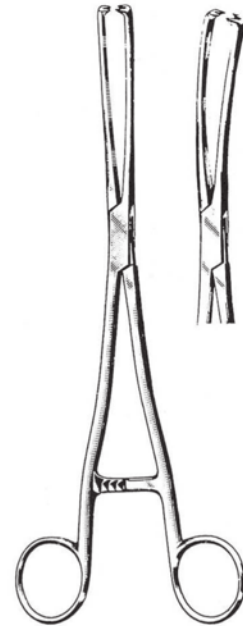
6mm



8mm

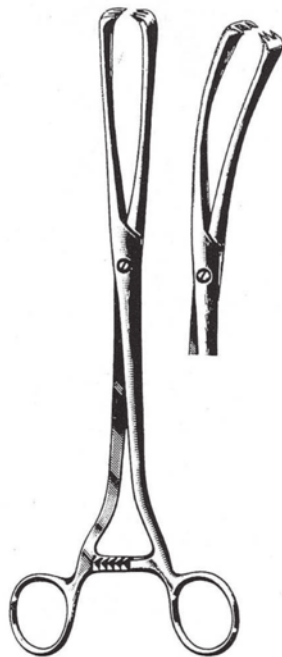


10mm



**MUSEUX**

straight	24.0cm	curved sideway
60.0634.06	6mm	60.0635.06
60.0634.08	8mm	60.0635.08
60.0634.10	10mm	60.0635.10



**MUSEUX**

straight	26.0cm	curved sideway
60.0638.09	9mm	60.0639.09
60.0638.11	11mm	60.0639.11
60.0638.13	13mm	60.0639.13



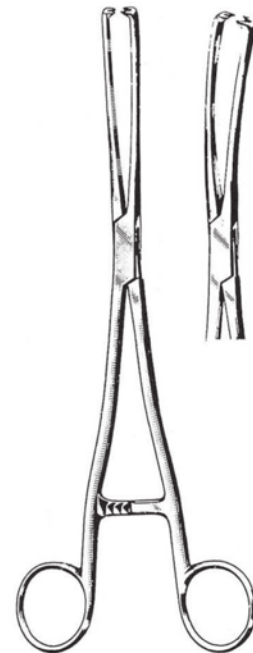
9mm



11mm



13mm



**MUSEUX**

straight	26.0cm	curved sideway
60.0642.09	9mm	60.0643.09
60.0642.11	11mm	60.0643.11
60.0642.13	13mm	60.0643.13



**JACOBS**  
60.0646.21 21.0cm 60.0647.21



**HENROTIN**  
60.0650.20 20.0cm



**BRAUN**  
60.0654.15 15.5cm



**CZERNY**  
60.0660.20 20.5cm



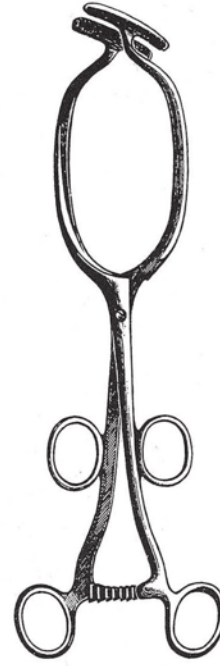
60.0664.26 26.0cm



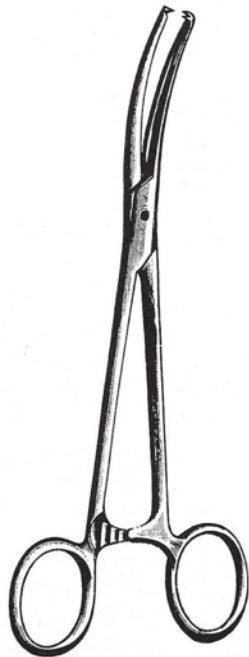
**PRATT**  
60.0668.28 28.0cm



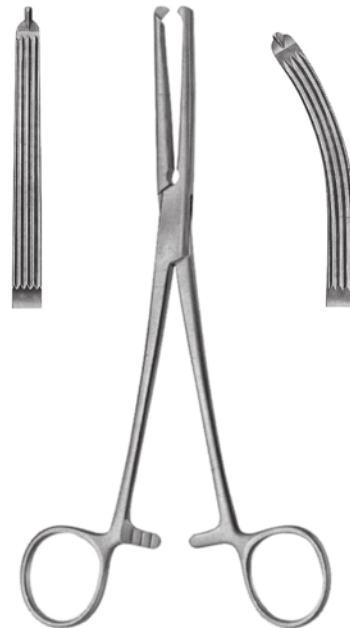
**BONNEY**  
60.0672.27 27.0cm



**BONNEY**  
60.0674.27 27.0cm



**MAINGOT**  
60.0676.20 20.0cm 60.0677.20  
60.0676.24 24.0cm 60.0677.24



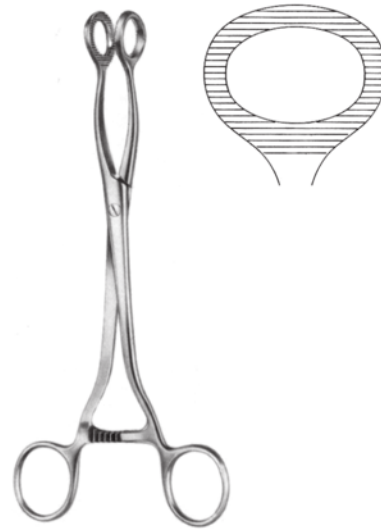
**GWILLIAM**  
60.0678.20 20.0cm 60.0679.20



**KELLY**  
60.0684.32 32.0cm



**NOTO**  
60.0690.27 27.0cm



**DOYEN**  
60.0694.20 20.0cm



**DARTIGUES**  
60.0700.27 27.0cm



**SOMER**  
60.0704.23 23.0cm



**PRUESMANN**  
60.0710.27 27.5cm



**COLLIN**  
60.0714.25 25.0cm



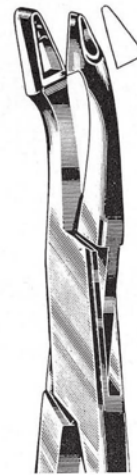
**THOMS-GAYLOR**  
60.0750.24 24.0cm



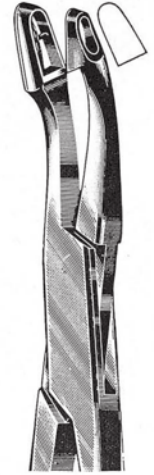
**THOMS-GAYLOR**  
60.0754.22 22.0cm  
60.0754.24 24.0cm



**VAN DOREN**  
24.0cm



60.0760.01



60.0760.02



**GELLHORN**  
60.0764.23 23.0cm



**FAURE**  
60.0770.21 21.0cm

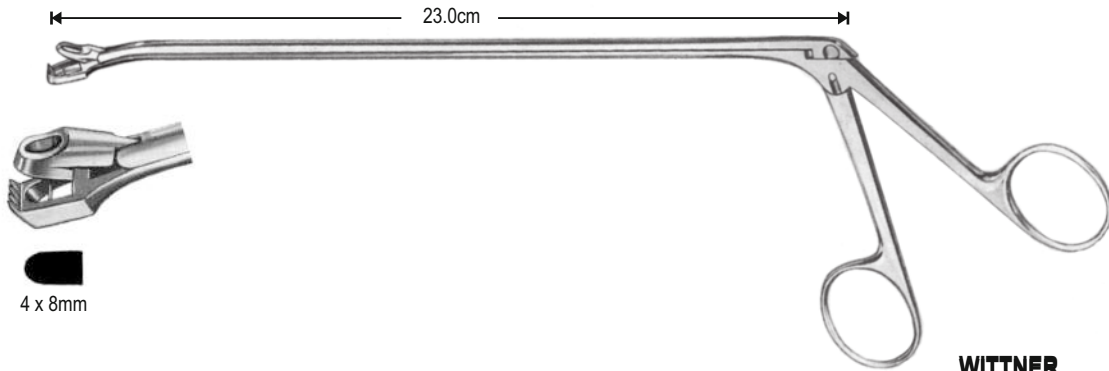


**SCHUBERT**  
60.0774.26 26.0cm

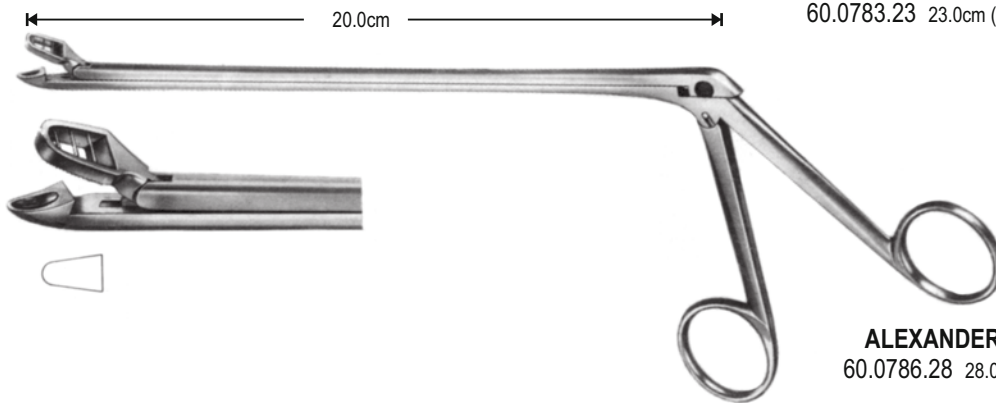


**SCHUBERT**  
60.0778.21 21.0cm  
60.0778.29 29.0cm

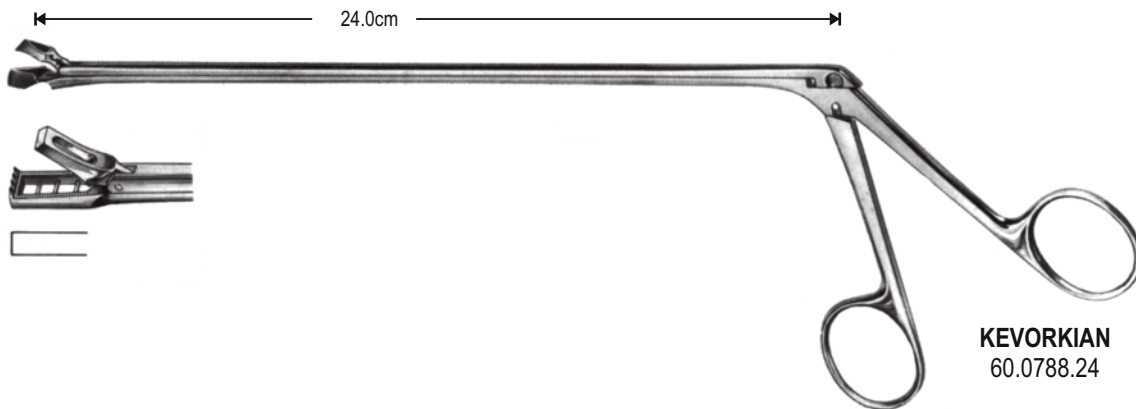




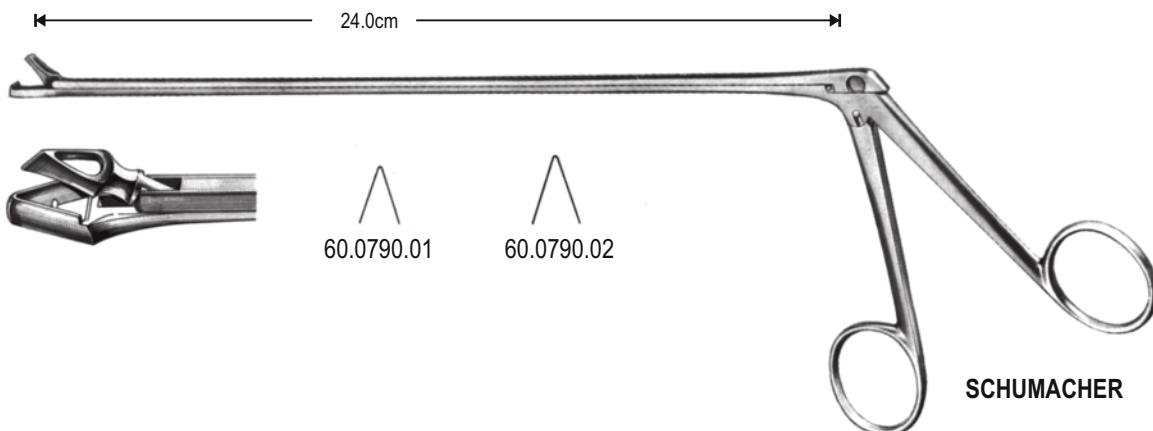
60.0782.23 23.0cm (straight)  
60.0783.23 23.0cm (angled)



60.0786.28 28.0cm



60.0788.24





■ 2.3 x 4.2 mm



**TOWNSEND-MINI**  
60.0792.00



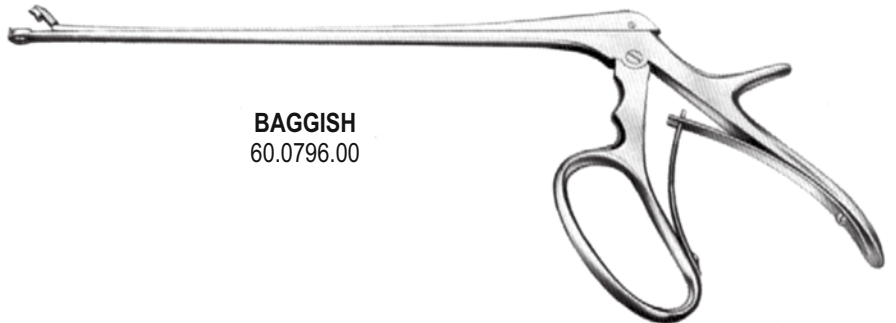
■ 3 x 9.5 mm



**TISCHLER-KEVORKIAN**  
60.0794.00



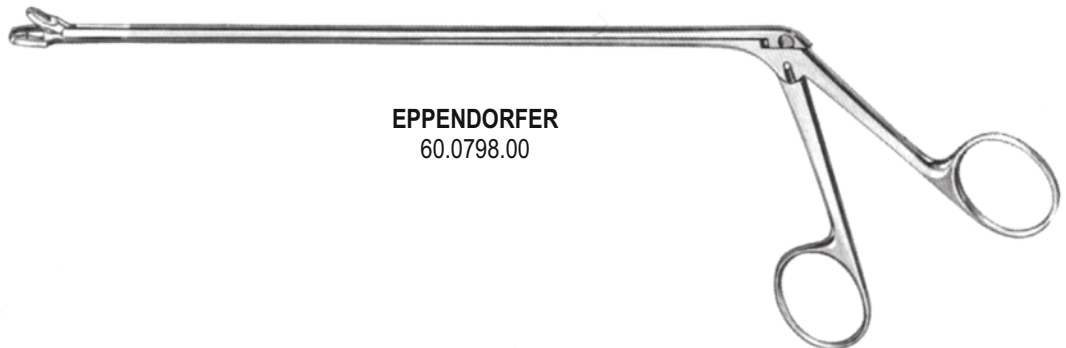
● 4 x 6.5 mm



**BAGGISH**  
60.0796.00



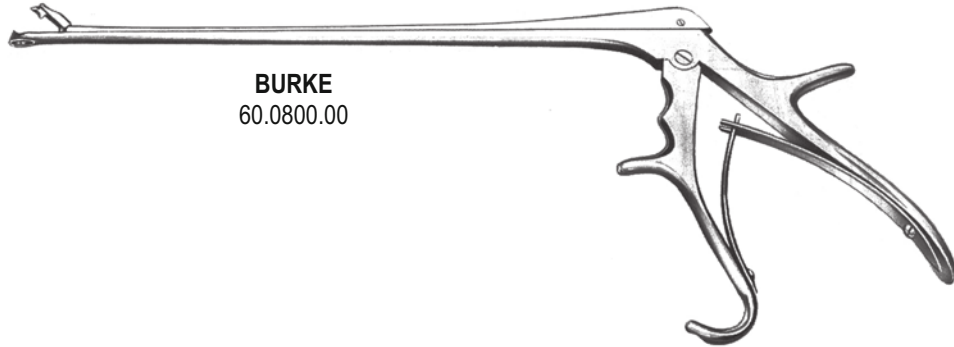
■ 4 x 8 mm



**EPPENDORFER**  
60.0798.00



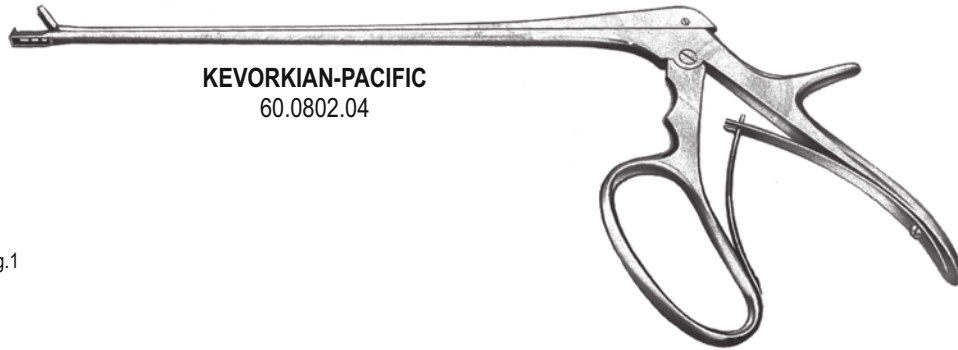
oval  
7 x 5 mm



**BURKE**  
60.0800.00



3 x 8 mm



**KEVORKIAN-PACIFIC**  
60.0802.04



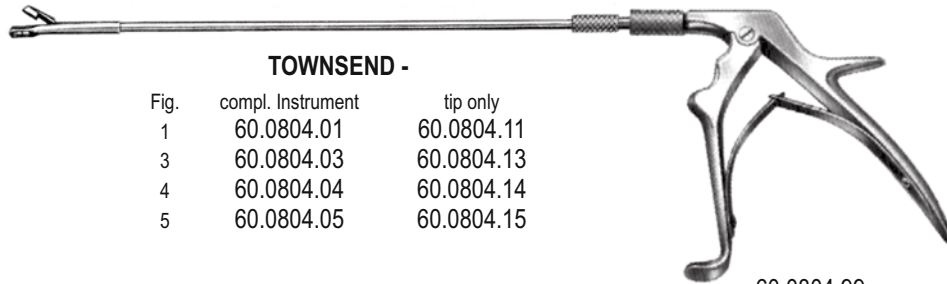
Fig.1

**TISCHLER-MORGAN**



Fig.3

oval ● 3.7 x 5 mm



**TOWNSEND -**

Fig.	compl. Instrument	tip only
1	60.0804.01	60.0804.11
3	60.0804.03	60.0804.13
4	60.0804.04	60.0804.14
5	60.0804.05	60.0804.15

60.0804.99  
handle only



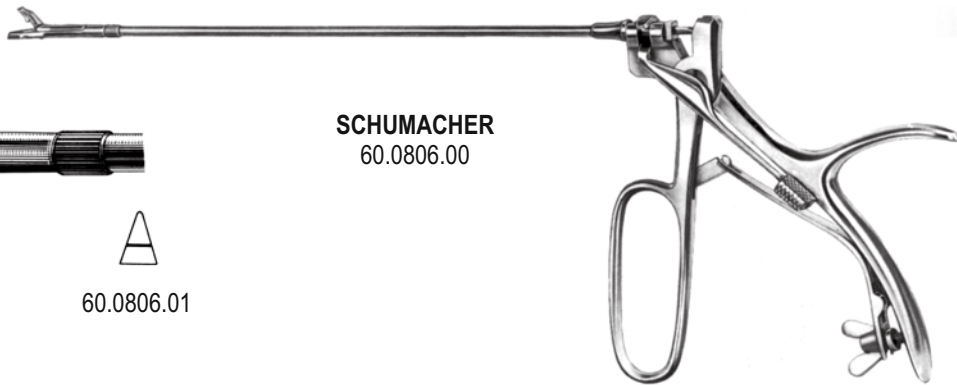
Fig.4

**KEVORKIAN**



Fig.5

mini



**SCHUMACHER**  
60.0806.00







Tip only



60.0806.01









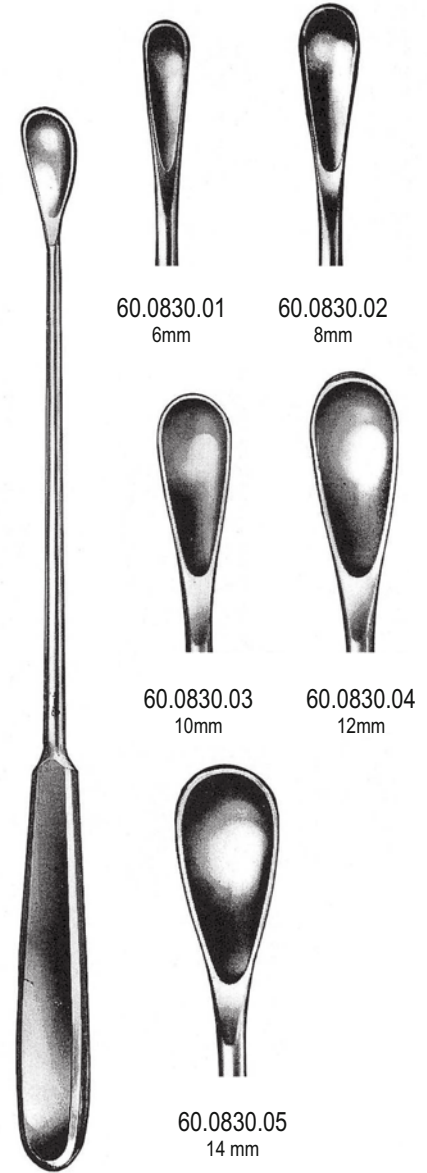
**SIMON**  
25.0cm, sharp, rigid

-  60.0820.01
-  60.0820.02
-  60.0820.03
-  60.0820.04
-  60.0820.05
-  60.0820.06








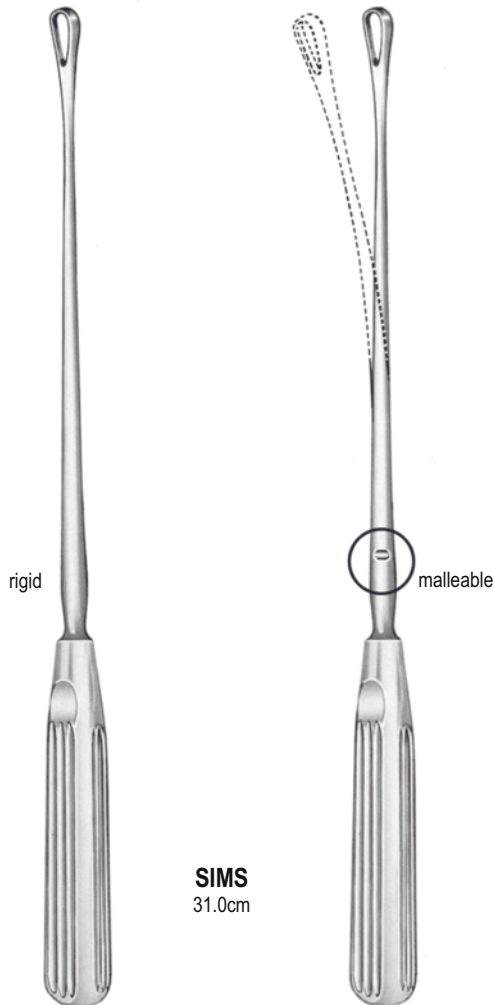
**SCHROEDER**  
30.0cm, sharp, rigid

-  60.0824.01
-  60.0824.02
-  60.0824.03
-  60.0824.04
-  60.0824.05
-  60.0824.06

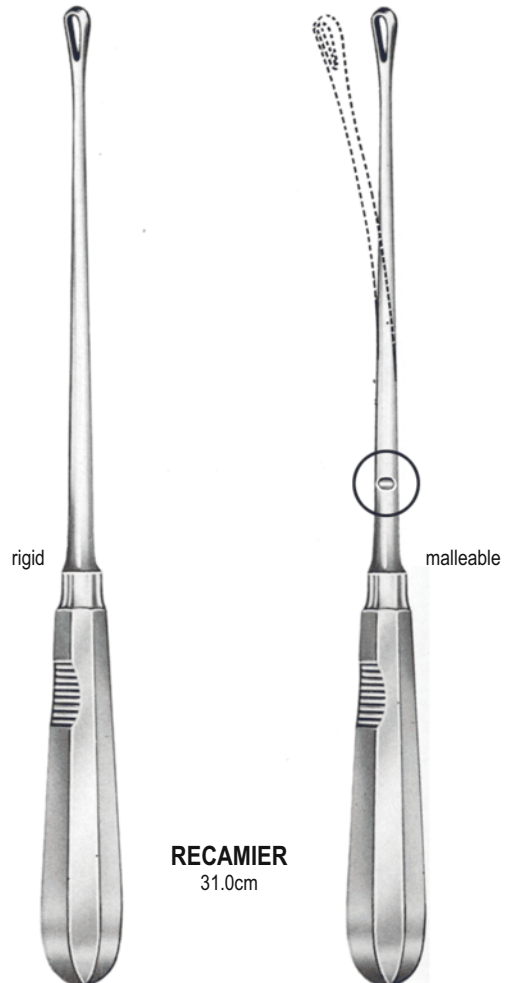


**GOURDET**  
28.0cm, blunt

-  60.0830.01  
6mm
-  60.0830.02  
8mm
-  60.0830.03  
10mm
-  60.0830.04  
12mm
-  60.0830.05  
14 mm



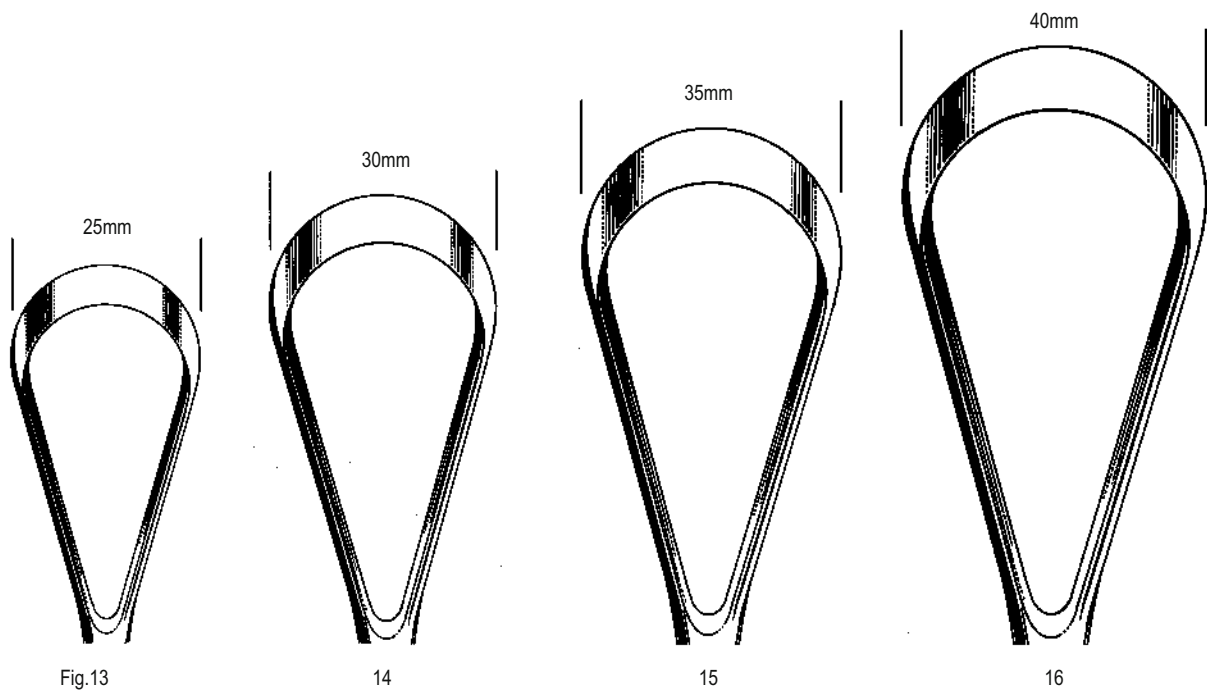
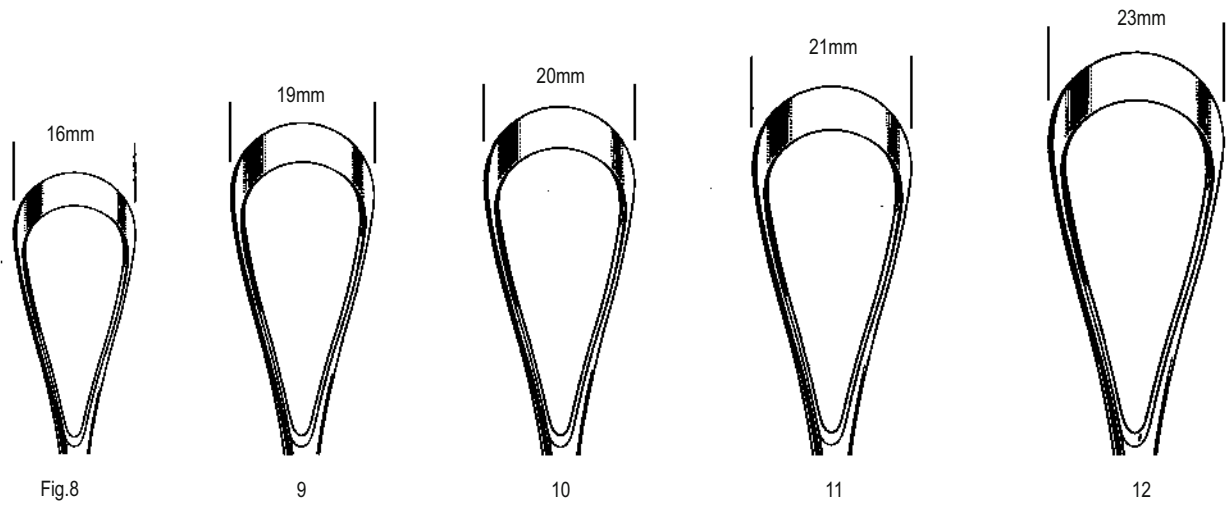
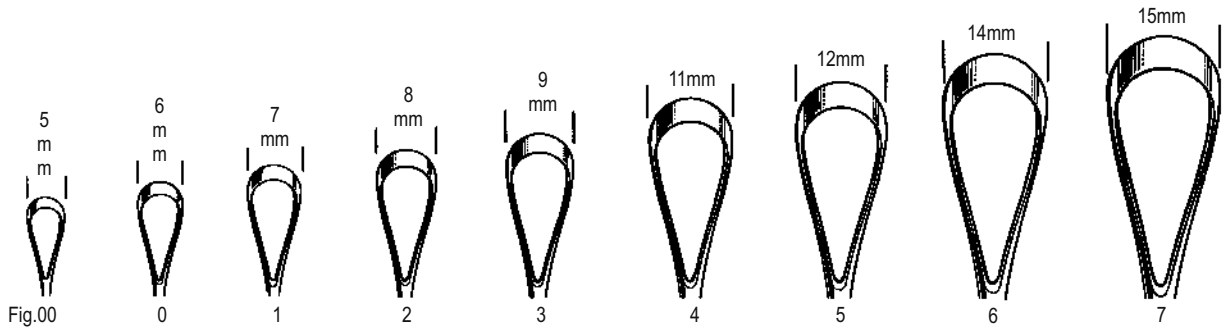
**SIMS**  
31.0cm



**RECAMIER**  
31.0cm

Fig	sharp	blunt	sharp	blunt
00	60.0840.05	60.0842.05	60.0844.05	60.0846.05
0	60.0840.06	60.0842.06	60.0844.06	60.0846.06
1	60.0840.07	60.0842.07	60.0844.07	60.0846.07
2	60.0840.08	60.0842.08	60.0844.08	60.0846.08
3	60.0840.09	60.0842.09	60.0844.09	60.0846.09
4	60.0840.11	60.0842.11	60.0844.11	60.0846.11
5	60.0840.12	60.0842.12	60.0844.12	60.0846.12
6	60.0840.14	60.0842.14	60.0844.14	60.0846.14
7	60.0840.15	60.0842.15	60.0844.15	60.0846.15
8	60.0840.16	60.0842.16	60.0844.16	60.0846.16
9	60.0840.19	60.0842.19	60.0844.19	60.0846.19
10	60.0840.20	60.0842.20	60.0844.20	60.0846.20
11	60.0840.21	60.0842.21	60.0844.21	60.0846.21
12	60.0840.23	60.0842.23	60.0844.23	60.0846.23
13	60.0840.25	60.0842.25	60.0844.25	60.0846.25
14	60.0840.30	60.0842.30	60.0844.30	60.0846.30
15	60.0840.35	60.0842.35	60.0844.35	60.0846.35
16	60.0840.40	60.0842.40	60.0844.40	60.0846.40

Fig	sharp	blunt	sharp	blunt
00	60.0850.05	60.0852.05	60.0854.05	60.0856.05
0	60.0850.06	60.0852.06	60.0854.06	60.0856.06
1	60.0850.07	60.0852.07	60.0854.07	60.0856.07
2	60.0850.08	60.0852.08	60.0854.08	60.0856.08
3	60.0850.09	60.0852.09	60.0854.09	60.0856.09
4	60.0850.11	60.0852.11	60.0854.11	60.0856.11
5	60.0850.12	60.0852.12	60.0854.12	60.0856.12
6	60.0850.14	60.0852.14	60.0854.14	60.0856.14
7	60.0850.15	60.0852.15	60.0854.15	60.0856.15
8	60.0850.16	60.0852.16	60.0854.16	60.0856.16
9	60.0850.19	60.0852.19	60.0854.19	60.0856.19
10	60.0850.20	60.0852.20	60.0854.20	60.0856.20
11	60.0850.21	60.0852.21	60.0854.21	60.0856.21
12	60.0850.23	60.0852.23	60.0854.23	60.0856.23
13	60.0850.25	60.0852.25	60.0854.25	60.0856.25
14	60.0850.30	60.0852.30	60.0854.30	60.0856.30
15	60.0850.35	60.0852.35	60.0854.35	60.0856.35
16	60.0850.40	60.0852.40	60.0854.40	60.0856.40



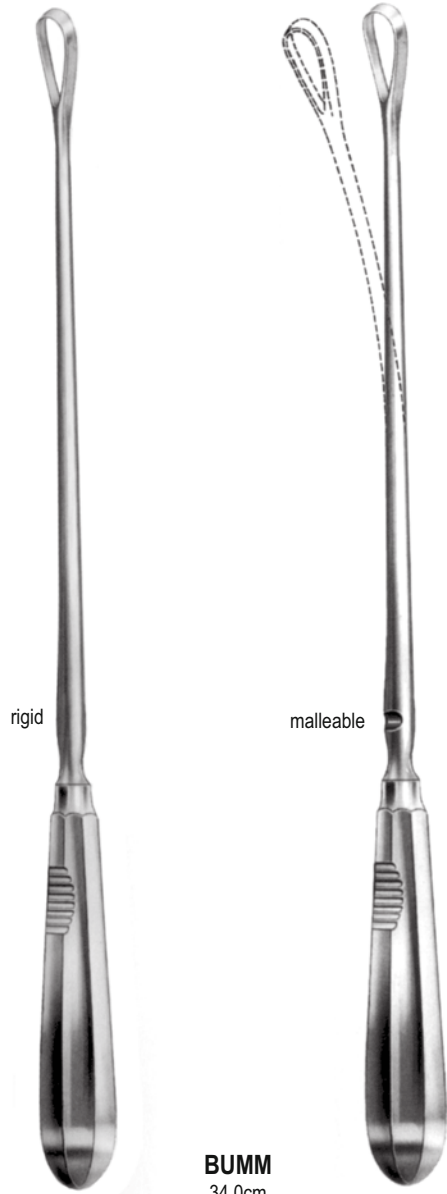
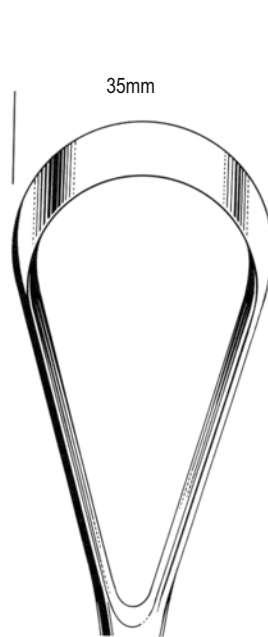


Fig. 13



14

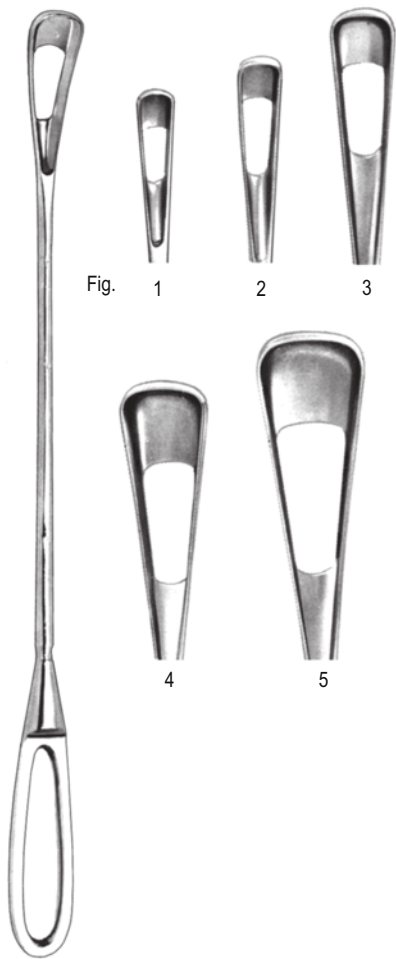


15



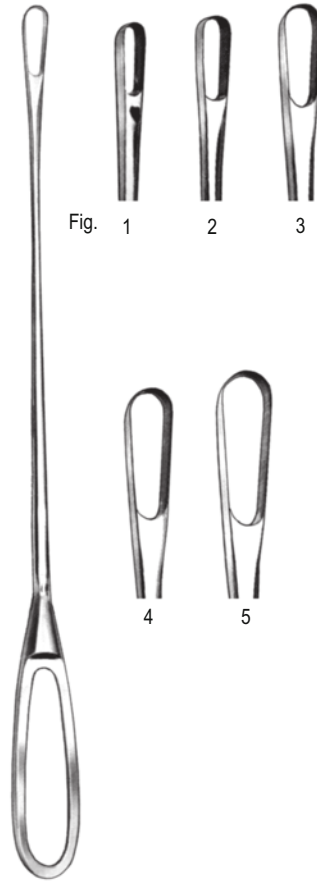
16

Fig	sharp	blunt	sharp	blunt
13	60.0860.25	60.0862.25	60.0864.25	60.0866.25
14	60.0860.30	60.0862.30	60.0864.30	60.0866.30
15	60.0860.35	60.0862.35	60.0864.35	60.0866.35
16	60.0860.40	60.0862.40	60.0864.40	60.0866.40



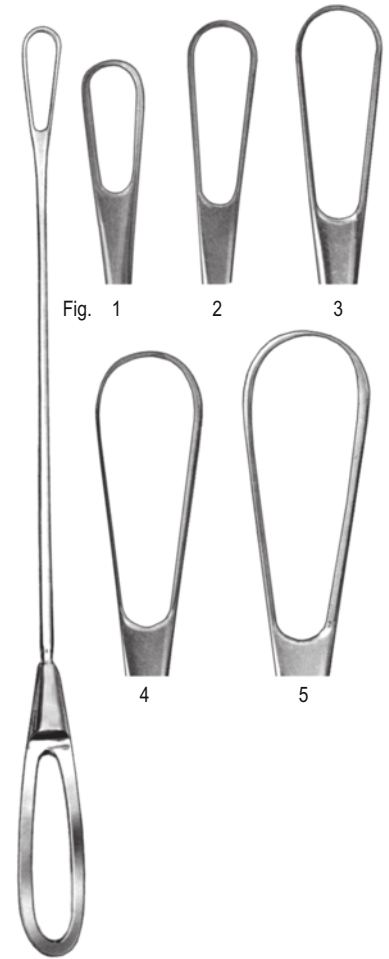
28.0cm

Fig.	Code	mm
1	60.0870.01	4.5
2	60.0870.02	6
3	60.0870.03	9
4	60.0870.04	12
5	60.0870.05	15



OLSHAUSEN'S  
27.0cm

Fig.	Code
1	60.0874.01
2	60.0874.02
3	60.0874.03
4	60.0874.04
5	60.0874.05



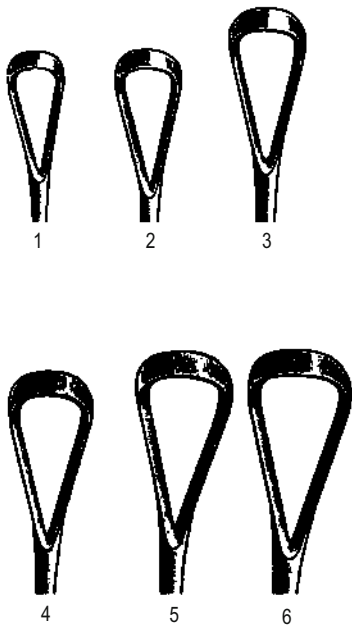
BUMM'S  
28.0cm

Fig.	Code
1	60.0878.01
2	60.0878.02
3	60.0878.03
4	60.0878.04
5	60.0878.05



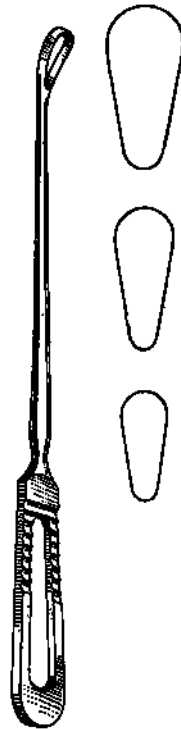


Fig.



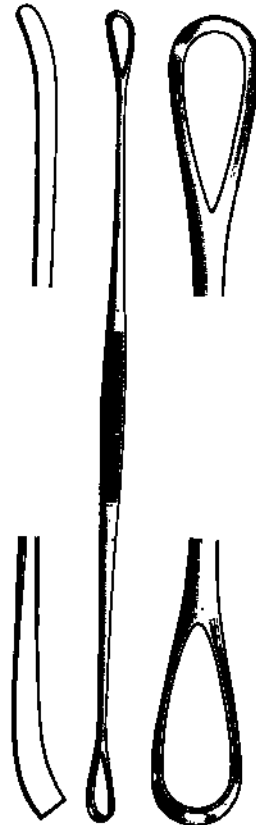
**SIMS**  
25.0cm

sharp	Fig	blunt
60.0880.01	1	60.0882.01
60.0880.02	2	60.0882.02
60.0880.03	3	60.0882.03
60.0880.04	4	60.0882.04
60.0880.05	5	60.0882.05
60.0880.06	6	60.0882.06

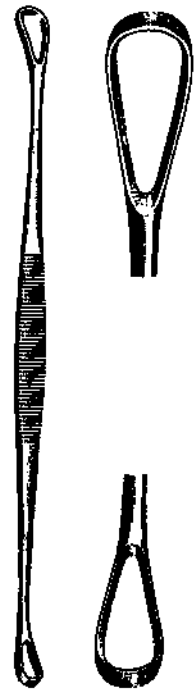


**SIMS**  
25.0cm

sharp	Fig	blunt
60.0884.01	1	60.0886.01
60.0884.02	2	60.0886.02
60.0884.03	3	60.0886.03



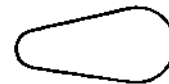
sharp / blunt  
60.0890.27 27.0cm



**BLAKE**  
sharp / blunt  
60.0894.27 27.0cm

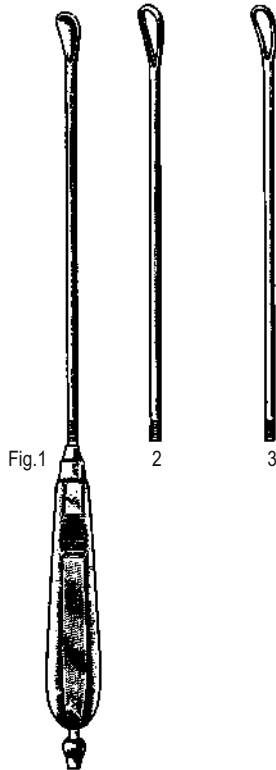


**SIMS**  
60.0900.25  
25.0cm, sharp



**SIMS**  
60.0902.25  
25.0cm, sharp / blunt





**UNIVERSAL**  
28.0cm

- Fig  
1 60.0906.01  
2 60.0906.02  
3 60.0906.03



**RHEINSTADTER**  
29.0cm

- |            |         |            |       |
|------------|---------|------------|-------|
|            | sharp   |            | blunt |
| 60.0910.01 | 7.9 mm  | 60.0912.01 |       |
| 60.0910.02 | 11.1 mm | 60.0912.02 |       |
| 60.0910.03 | 14.3mm  | 60.0912.03 |       |



**CHELSEA HOSPITAL**  
60.0916.31 31.0cm



**DONALD**  
sharp  
60.0920.33 33.0cm



**RANDALL**

24.0cm  
60.0924.01 1mm dia.  
60.0924.02 2mm dia.  
60.0924.03 3mm dia.  
60.0924.04 4mm dia.



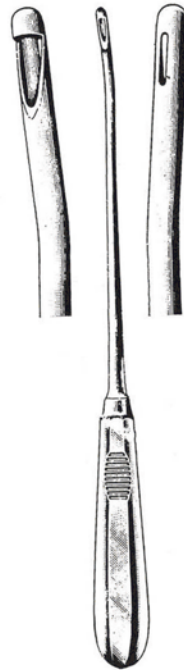
**NOVAK**

23.0cm  
60.0930.01  
60.0930.02  
60.0930.03  
60.0930.04



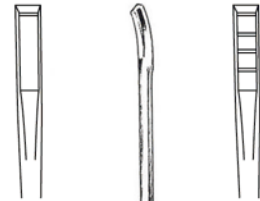
**SHERMAN**

60.0934.23 23.0cm  
3.5mm dia.



**MUENCHEN**

60.0940.27 27.0cm



with basket



**KEVORKIAN**

30.0cm  
60.0944.12 1.2mm  
60.0944.40 4.0mm  
60.0946.12  
60.0946.40